

Artemide®



2	Artemide. The History
6	Artemide. The Designers
8	Artemide. Elliott Erwitt. A Tribute to Light
16	Artemide. The Human Light
18	Artemide. The Responsible Light
20	Artemide. The Innovation
22	Artemide. The Good Light
24	Artemide. The Network
25	The Total Cost Ownership
26	Catalogues
28	Artemide. 5 Years Warranty
30	Index
32	Alphabetical index
38	IN-EI ISSEY MIYAKE
60	Table lamps
134	Floor lamps
202	Wall Ceiling lamps
324	Suspension lamps
416	Master's Pieces
446	Artemide. Augmented Reality
448	General legenda
450	Light sources
452	Energy label
454	Customer service
456	Addresses

Artemide. The History

Innovation

Products



1st product



Ro
BBPR



Omega
Vico Magistretti



Nesso
Giancarlo Mattioli
Gruppo architetti
urbanisti città nuova



Eclisse
Vico Magistretti

11st January 1960



Eclisse:
Compasso d'Oro
1969

Communication



1st catalogue

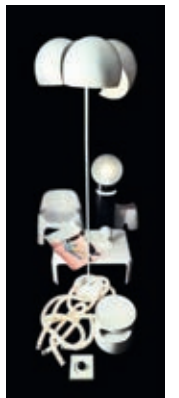



MoMA
 MUSEO TAMAYO
 YO
 M
 V&A
 DENVER ART MUSEUM

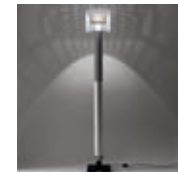
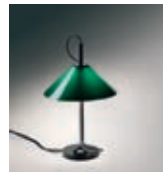

YO M

Boalum
 Livio Castiglioni
 Gianfranco Frattini

Tizio
 Richard Sapper

Aggregato
 Enzo Mari

Callimaco
 Ettore Sottsass

Montjuic
 Santiago Calatrava

Shogun
 Mario Botta

Patroclo
 Gae Aulenti

Megaron
 Giancarlo Frattini

logotype Artemide
 (Emilio Fioravanti)

1970

1980

Artemide



Innovation

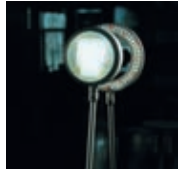
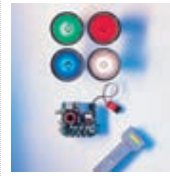

Products

Artemide
litech

Artemide
COLLEZIONI

Artemide
ARCHITECTURAL

Artemide
modern classic

Artemide
METAMORFOSI

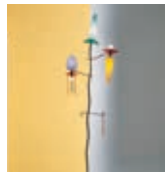

Aton barra
Ernesto Gismondi

Tolomeo
Michele De Lucchi

Giocasta
Andrea Anastasio

Surf
Neil Poulton

Chimera
Vico Magistretti

Yang
Carlotta de Bevilacqua

Metamorfosi
Ernesto Gismondi
Innovation patent
n. 97100602.8

Kaio Led
Ernesto Gismondi

Dioscuri
Michele De Lucchi

1990



Artemide:
Compasso d'Oro
1995



European Design Price
1997

2000

Communication

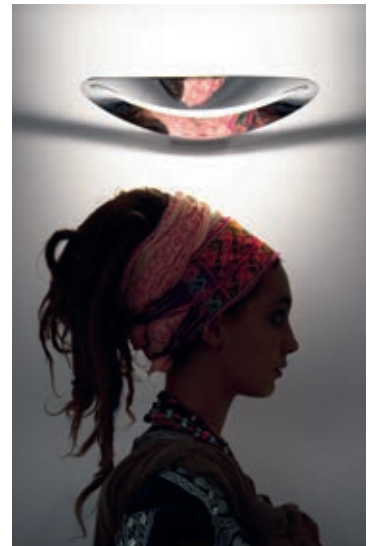

ADV:
Cannes bronze Lion
1999





MoMA

also

MY.WHTELIGHT®

Artemide Outdoor

Masters Pieces



Rigel
Carlotta de Bevilacqua

Metacolor
Ernesto Gismondi

Solar tree
Ross Lovegrove

Copernico
Carlotta de Bevilacqua
Innovation patent
n. MI20104000610

Led Net
Michele De Lucchi

Cata
Carlotta de Bevilacqua
Innovation patent
n. MI2012A000605

IN-EI
Issey Miyake

Demetra
Naoto Fukasawa

Incalmo
Carlotta de Bevilacqua

e.light
Ernesto Gismondi
Innovation patent
n. PCTIT0000184

Pipe
Herzog & De Meuron

Mercury
Ross Lovegrove

Pausania
Ettore Sottsass

Pirce
Giuseppe Maurizio
Scutellà

Meteorite
Pio & Tito Toso



Pipe:
Compasso d'Oro
2004

2010



IN-EI:
Compasso d'Oro
2014

2015

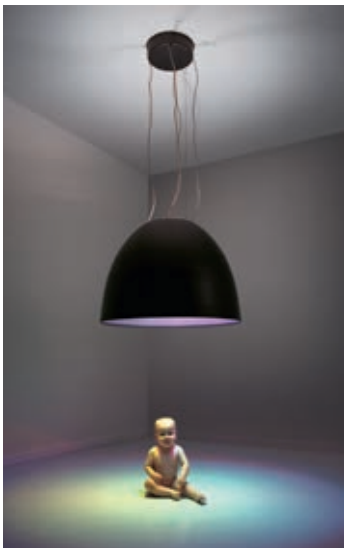

Artemide. The Designers



Gae
Aulenti

Santiago
Calatrava

Carlotta
de Bevilacqua

Ernesto
Gismondi

James
Irvine

Vico
Magistretti

Issey
Miyake

BBPR

Livio
Castiglioni

Michele
De Lucchi

Adrien
Gardère

Ora
Ito

Enzo
Mari

Alessandro
Mellini

Klaus
Begasse

Toni
Cordero

Naoto
Fukasawa

Zaha
Hadid

Ross
Lovegrove

Sergio
Mazza

Javier
Mariscal

Mario
Botta

Carlo
Forcolini

Herzog
& de Meuron

Guido
Matta,
Enrico
Girotti

Gianfranco
Fratini



Giancarlo
Mattioli

Gio
Ponti

Ennio
Pasini

Aldo
Rossi

Ettore
Sottsass

Massimo
Tassone

Jean Michel
Wilmotte

MiloDaMalo

Neil
Poulton

Roberto
Paoli

Franco
Raggi

Richard
Sapper

Matteo
Thun

Scott
Wilson

Jean
Nouvel

Daniela
Puppa,
Francesca
Martelli

Italo
Rota,
Alessandro
Pedretti

Giuseppe
Maurizio
Scutellà

Pio
&
Tito
Toso

Katim
Rashid

Eric
Solé

Luciano
Vístosi

Emanuele
Ricci

Artemide. Elliott Erwitt. A Tribute to Light



Michele De Lucchi - Giancarlo Fassina: Tolomeo

“Un omaggio alla luce, fortemente orientato al futuro”: è questo, con le parole di Ernesto Gismondi, il concept di comunicazione della campagna internazionale “A Tribute to light”, scattata dal celebre fotografo, Elliott Erwitt, il cui sguardo da molto tempo è un importante compagno di viaggio nella bellissima avventura Artemide. Con queste immagini la campagna va ben oltre il funambolismo visivo della comunicazione di oggi, entrando in un territorio nuovo dove il valore è quello delle idee e dei contenuti e la genialità è quella delle persone che li pensano e li realizzano; il mondo in cui ambiente e uomo sono il parametro e fine, il mondo della luce di Artemide.



Ernesto Gismondi: 90°



Carlotta de Bevilacqua - Paolo Dell'Elce: Copernico



Naoto Fukasawa: Demetra



Richard Sapper: Tizio

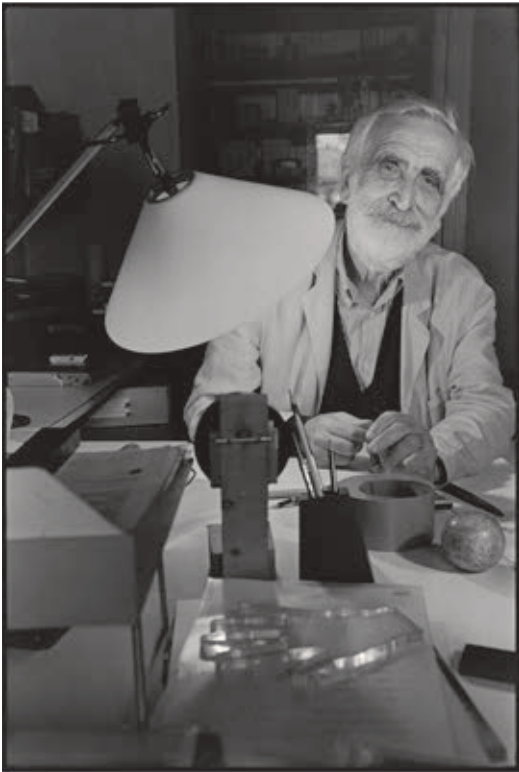

Enzo Mari: Aggregato



Michele De Lucchi: Led Net



Javier Mariscal: Lotek



Michele De Lucchi - Giancarlo Fassina: Tolomeo

"A strong, forward-looking tribute to light": this is how Ernesto Gismondi describes the ad concept of the new international campaign "A Tribute to light" directed by the renowned photographer Elliott Erwitt, who has been a great travel companion in the beautiful adventure of Artemide. With these images the campaign is aimed far beyond the visual plethora of modern communication, going into a new territory where real value lies in ideas and contents, and genius is in the people that conceive and implement them; a world where man and the environment are the core and the end point, the world of Artemide light.

«Un hommage à la lumière orienté fortement vers l'avenir»: c'est ainsi qu'Ernesto Gismondi décrit le concept de la nouvelle campagne internationale «A Tribute to light*» (*un hommage à la lumière) développé par le célèbre photographe Elliott Erwitt, qui a toujours été un grand compagnon de voyage dans la belle aventure d'Artemide. Par ces images, cette campagne va bien au-delà des acrobaties visuelles de la communication moderne, en entrant sur un nouveau territoire, où la valeur réelle réside dans les idées et le contenu, et le génie réside dans les personnes qui les conçoivent et les produisent ; le monde où l'Homme et son environnement représentent le noyau et le point final, le monde de la lumière Artemide.

„Eine zukunftsorientierte Hommage an das Licht“, so beschreibt Ernesto Gismondi das Kommunikationskonzept der internationalen Kampagne "A Tribute to light". Die Kampagne wurde von dem bekannten Fotografen Elliott Erwitt entwickelt, einem ständigen Begleiter auf der Abenteuerreise „Artemide“. Mit diesen Bildern geht die Kampagne weit über die visuellen Künste der modernen Kommunikation hinaus und betritt ein Neuland, wo die wahren Werte in den Ideen und Inhalten liegen und die Genialität in den Personen, die sie entwickeln. Eine Welt, in der Mensch und Umwelt die Parameter und den Endpunkt bilden. Die Welt des Lichts von Artemide.

"Un homenaje a la luz, fuertemente orientado al futuro": es esto, con las palabras de Ernesto Gismondi, el concepto de comunicación de la campaña internacional "A Tribute to light", desarrollada por el célebre fotógrafo, Elliott Erwitt, que ha sido un gran compañero de viaje en la bella aventura de Artemide. Con estas imágenes la Campaña va mucho más allá de las acrobacias visuales de la comunicación moderna, entrando en un territorio nuevo donde el valor es el de las ideas y de sus contenidos y la genialidad es de las personas que las piensan y las acaban realizando; el mundo en el que el hombre y su entorno representan el núcleo y el punto final, el mundo de la luz Artemide.



Jean Nouvel: Objective



Carlotta de Bevilacqua - Paola di Arianello: Empatia



Ernesto Gismondi with the R&D team: Nur



Ernesto Gismondi: Ilio



Italo Rota - Alessandro Pedretti: Calenda



Carlotta de Bevilacqua: Cata

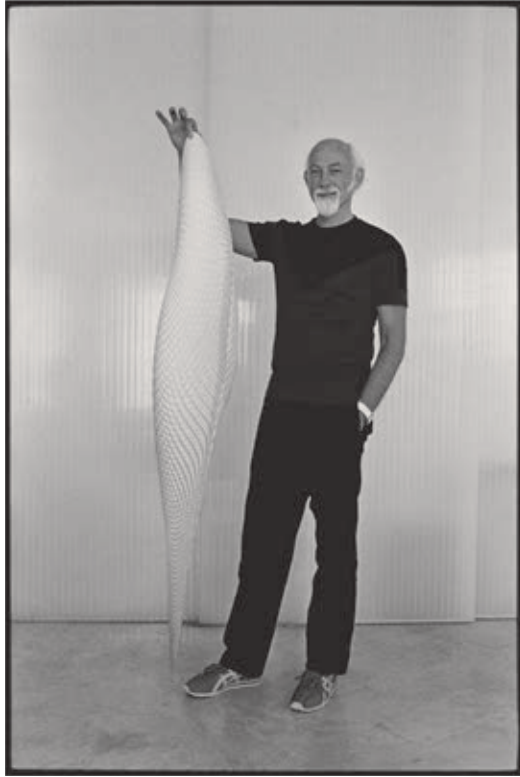

Ross Lovegrove: Cosmic Leaf



Karim Rashid: Doride



Ross Lovegrove: Solar Tree



Neil Poulton: Ipparco

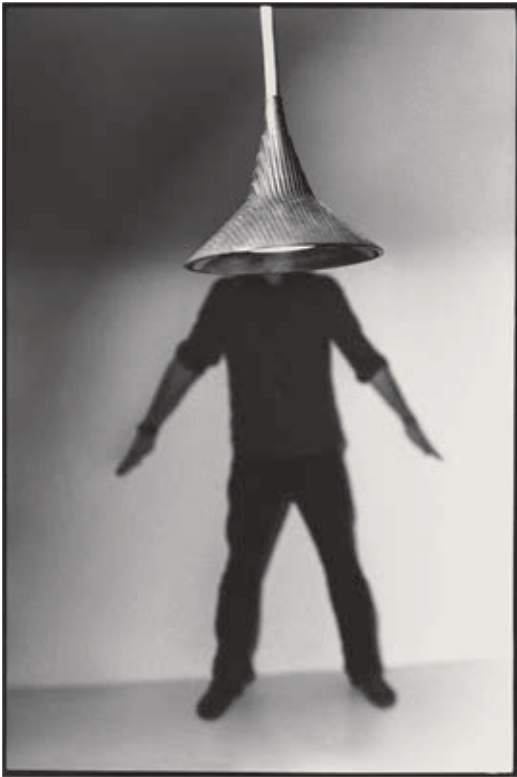

Herzog & de Meuron: Unterlinden



Giuseppe Maurizio Scutellà: Pirce



Scott Wilson: Sisifo



Michele De Lucchi - Giancarlo Fassina: Tolomeo



Jean Nouvel: Equilibrist



Elliott Erwitt.

American photographer of Russian descent, born in Paris in 1928. After living in Paris and Milan, he moved to Los Angeles (1940) and then to New York, where he attended the New School for Social Research.

Erwitt was influenced by his meetings with famous photographers such as Edward Steichen, Robert Capa and Roy Stryker. The latter, director at the time of the Photography department at the Farm Security Administration, hired Erwitt to work on a photographic project for Standard Oil.

After this period he embarked on a career as a freelance photographer, working for magazines like Collier's, Look, Life and Holiday or companies like Air France and KLM. In 1953 he joined the prestigious Magnum Photos agency, an association that gave him a great deal of visibility and allowed him to undertake photographic projects all over the world. He eventually became its president (1968), a position he held for three terms. Interested in subjects from everyday life, he brings irony and wit to his photographs of street

scenes, situations where the protagonists can be human beings or animals, especially dogs. His photos, displayed in several collections (Museum of Modern Art, New York; Institute of Art, Chicago; etc.), have been shown during a number of exhibitions. From 2006 he has been leading Artemide Human Light advertising campaigns.

Artemide. The Human Light

La luce è una presenza quotidiana nelle nostre vite. Centrale è da sempre nella visione di Artemide il rapporto tra uomo, luce e ambiente, che negli anni si è sviluppato declinandosi dagli aspetti rivolti al benessere dell'individuo e alla sua percezione degli spazi, fino a confrontarsi con i temi legati alla sostenibilità ambientale.

The Human Light è la luce in grado di seguire il fluire dei ritmi, dei comportamenti e delle emozioni degli individui, la luce progettata per il benessere psicologico dell'uomo, in grado di offrire nuove qualità, emozioni e consapevolezza alla nostra vita e di aprire una visione innovativa e responsabile sul futuro del mondo.

Con The Human Light la luce diviene materia prima plasmabile, strumento attivo a supporto del Sé, un mezzo per riappropriarsi di stimoli e sensazioni. L'autodeterminazione nel rapporto che si crea tra luce e uomo, va interpretata non solo come diritto di gestione flessibile alla portata di tutti, ma soprattutto come un dovere progettuale.

Light is a daily presence in our lives. The relationship between people, light and the environment has always been central to Artemide vision and has been developed over the years. The research subjects range from the individuals' well-being and perception of spaces, to tackling the issues associated with environmental sustainability. The Human Light is a light able to follow the individuals' flow of behaviours and emotions. It is designed to help achieving psychological well-being and offering new qualities, emotions and awareness to our lives while developing an innovative and responsible vision of the future. With The Human Light, light becomes a mouldable raw material, an active tool to support the Self, a way of resuming motivations and sensations. Self-awareness in the relationship between people and light must be interpreted not only as flexible management of light within reach, but above all as a priority in the design process.

La lumière est une présence quotidienne dans nos vies. Occupant depuis toujours une position centrale dans la philosophie d'Artemide, le rapport entre l'Homme, la lumière et l'environnement s'est développé au fil des années en déclinant des aspects liés au bien-être de l'individu et à sa perception des espaces, jusqu'à la confrontation avec les questions liées à la durabilité environnementale.

The Human Light est la lumière à même de suivre le flux des rythmes des comportements et des émotions des individus, la lumière conçue pour le bien-être psychologique de l'Homme, à même d'offrir de nouvelles qualités, des émotions et la conscience à notre vie et d'ouvrir une appréhension novatrice et responsable de l'avenir du monde. Avec The Human Light, la lumière devient une matière première malléable, un instrument actif épaulant le Soi, un moyen pour se réappropriier les stimuli et les sensations. L'autodétermination dans le rapport qui s'instaure entre la lumière et l'Homme, doit être interprétée non seulement comme un droit de gestion flexible à la portée de tous, mais surtout comme un devoir conceptuel.

Licht hat in unserem täglichen Leben eine allgegenwärtige Präsenz. Die Beziehung zwischen Mensch, Licht und Umwelt bildet seit jeher ein zentrales Element für Artemide, das kontinuierlich in Bezug auf das Wohlbefinden des Menschen, des Raumpfindes sowie der Umweltverträglichkeit weiterentwickelt wurde.

The Human Light ist das Licht, das sich den Bedürfnissen des Menschen anpasst und dadurch in der Lage ist, eine neue Qualität, Emotionen und Bewusstsein in unser Leben zu bringen. Hierdurch eröffnet es eine innovative, verantwortliche Vision auf die Zukunft der Welt.

Mit The Human Light wird das Licht gestaltbarer Rohstoff, aktives Instrument zur Unterstützung des eigenen Ichs, ein Mittel, um sich Anreize und Gefühle anzueignen. Die Selbstbestimmung in der Beziehung, die zwischen Licht und Mensch entsteht, ist nicht nur als Recht flexibler Verwaltung für alle auszulegen, sondern vor allem als eine Planungspflicht.

La luz es una presencia cotidiana en nuestras vidas.

La visión de Artemide, desde siempre, se centra en las relaciones existentes entre el ser humano, la luz y el entorno. A lo largo de los años, la misma se ha ido desarrollando y concretando en varios aspectos: desde los que se concentran en el bienestar del individuo y en su manera de percibir los espacios hasta los que se relacionan con la sostenibilidad medioambiental. The Human Light es la luz capaz de ceñirse al fluir de los ritmos de las conductas y las emociones humanas. Es la luz diseñada a favor del bienestar psicológico de las personas.

Una luz, capaz de ofrecer nuevas cualidades, emociones y conciencia a nuestra vida, abriéndose a una visión innovadora y responsable sobre el futuro del mundo. Con The Human Light, la luz se transforma en materia prima que se puede plasmar, en herramienta activa a la hora de respaldar al Yo y en un medio para volvernos a adueñar de los estímulos y las sensaciones. La posibilidad de decidir qué relaciones han de crearse entre la luz y el ser humano, no solo se ha de interpretar como derecho a un manejo flexible y al alcance de todos sino, y por sobre todo, como un deber del diseño.

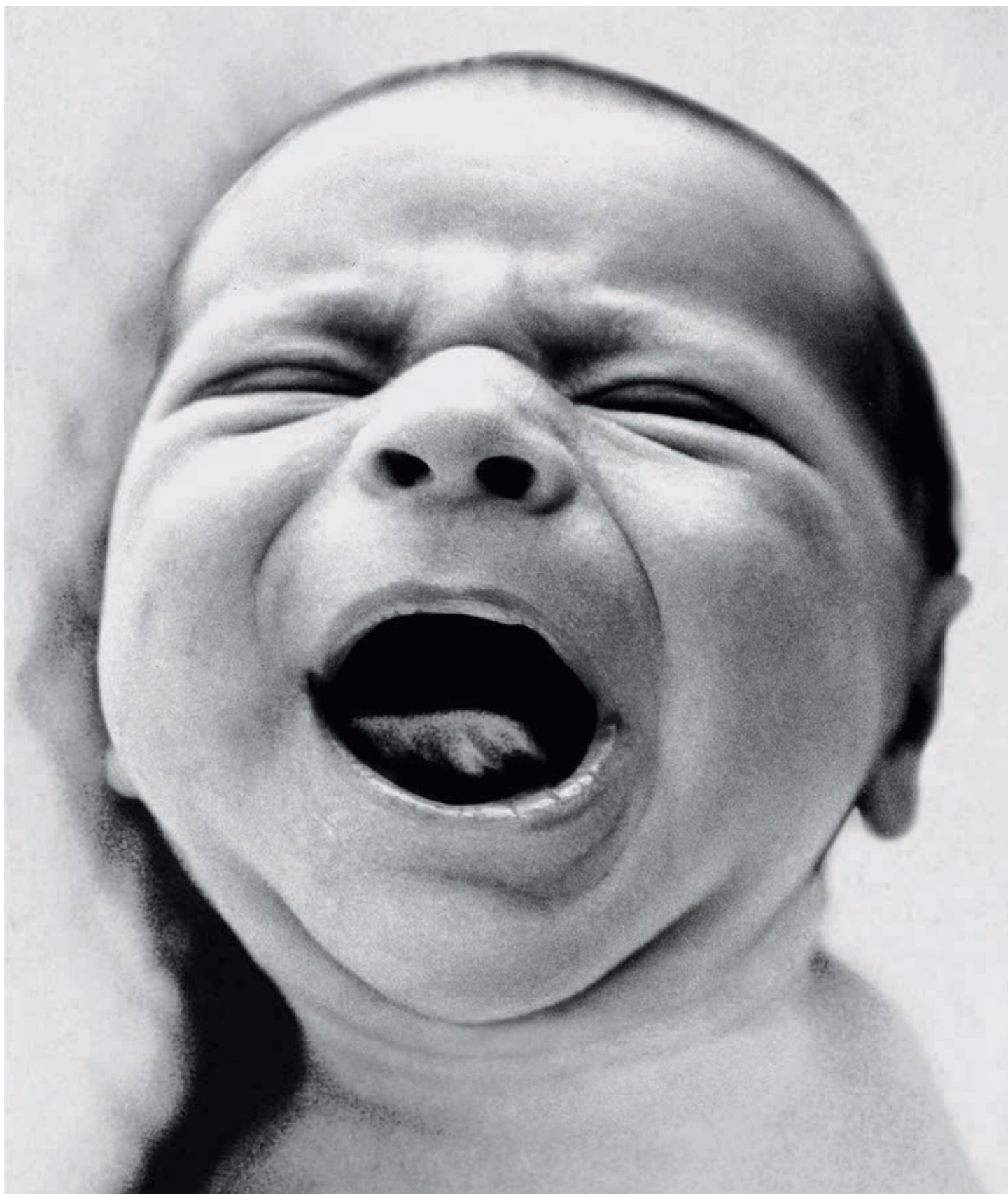

Life will be better with the right light

Artemide[®]
THE HUMAN LIGHT.

Artemide. The Responsible Light

LCA (Life Cycle Assessment)

La LCA è un approccio strategico utilizzato per valutare il potenziale impatto ambientale che un prodotto ha in tutte le fasi del suo ciclo di vita: scelta delle materie prime, lavorazioni, trasporto e assemblaggio, imballaggio, distribuzione, fase d'uso, dismissione e riciclaggio.

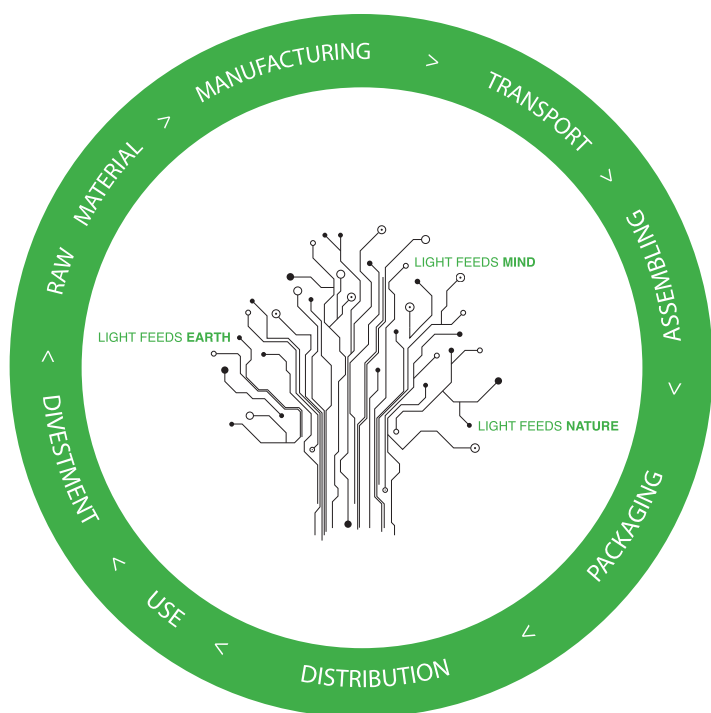

L'attività di ricerca di Artemide è costantemente impegnata a sviluppare ed adottare sistemi di illuminazione che perseguano l'obiettivo della massima efficienza energetica. Tutte le scelte progettuali sono focalizzate verso un unico obiettivo: migliorare la qualità della vita dell'uomo e il suo rapporto con l'ambiente. Nell'ambito di una politica di riduzione dei consumi energetici e in anticipo rispetto a vincoli normativi, sono quattro le aree di azione in cui si traduce concretamente l'impegno di Artemide:

Eco-Effectiveness

Massima attenzione al processo di progettazione e produzione: uso responsabile delle risorse, accurata scelta dei processi e delle tecnologie in un'ottica di bilancio energetico.

Long term

Progettare per la lunga durata attraverso un'attenta progettazione dell'intero ciclo di vita del prodotto promuovendo la formazione tecnica interna, utilizzando le esperienze maturate nell'ambito di ricerche sulla sostenibilità (LCA, analisi delle tecnologie, dei processi etc.) sviluppate con centri di ricerca universitari.

Responsible Consumption

Diffondere cultura e offrire strumenti per una scelta consapevole (TCO, LENI) e un utilizzo ragionato della luce, qualificandola in termini di risparmio energetico ed economico.

Quality

La qualità come un diritto fondamentale per un rapporto più duraturo con il prodotto e come requisito indispensabile per la ricerca di una autentica innovazione ambientale.

LCA is a strategic approach used to assess the potential environmental impact of a product during all stages of its life cycle: selection of raw materials, processing, transport and assembly, packaging, distribution, usage, disposal and recycling.

LCA est une approche stratégique utilisée pour évaluer le potentiel de l'impact environnemental d'un produit durant toutes les étapes de son cycle de vie : sélection des matières premières, traitement, transport et assemblage, emballage, distribution, phase d'utilisation, déchets et recyclage.

LCA , oder auch Ökobilanz, beschreibt die systematische Analyse der Wirkung von Produkten auf die Umwelt über den gesamten Produktlebenszyklus: Auswahl der Rohmaterialien, Verarbeitung, Transport und Montage, Verpackung, Vertrieb, Gebrauch, Entsorgung und Recycling.

La LCA es un enfoque estratégico utilizado para valorar el potencial impacto ambiental que un producto tiene en todas las fases de su ciclo de vida: elección de materias primas, procesos, transporte y montaje, embalaje, distribución, fase de uso, la destrucción y el reciclaje.

Artemide's research activity is constantly committed to developing and adopting lighting systems that pursue the objective of maximum energy efficiency. All project choices focus on a sole objective: to improve people's quality of life and their relationship with the environment. In the sphere of a policy of the reduction of energy consumption and being ahead of the regulatory requirements, there are four areas of action into which Artemide's commitment is specifically translated:

Les services de recherche d'Artemide travaillent constamment au développement et à l'adoption de systèmes d'éclairage visant à garantir la plus haute efficacité énergétique. Tous les choix conceptuels n'ont qu'un seul objectif : améliorer la qualité de vie de l'homme et son rapport avec l'environnement. Dans le cadre d'une politique éco-responsable et en avance par rapport aux contraintes normatives, il existe quatre zones d'action dans lesquelles Artemide s'est engagée de façon concrète :

Die Forschungstätigkeit von Artemide ist konstant damit beschäftigt, Beleuchtungssysteme mit maximaler Energieeffizienz zu entwickeln. Alle Planungsentscheidungen sind auf ein einziges Ziel ausgerichtet, nämlich die Lebensqualität des Menschen und seine Beziehung zur Umwelt verbessern. Im Rahmen einer vorausschauenden Energiesparpolitik gibt es vier Tätigkeitsbereiche, in denen sich das Engagement von Artemide fokussiert:

La actividad que Artemide despliega en el sector de la investigación aspira constantemente a desarrollar y utilizar sistemas de iluminación que persigan un objetivo: conseguir la máxima eficiencia energética. Todas las decisiones inherentes al diseño se focalizan hacia un único objetivo: mejorar la calidad de vida del ser humano y sus relaciones con el entorno. En el marco de una política que apunta a la disminución de los consumos energéticos y adelantándose a lo preceptuado en la normativa, el compromiso de Artemide se traduce concretamente en cuatro áreas de acción; a saber:

Eco-Effectiveness

Maximum attention is given to design and manufacturing processes: responsible use of resources, thorough choice of processes and technologies with a view to achieving energy balance.

Eco-Effectiveness

Une attention particulière au processus de conception et de production : emploi responsable des ressources, choix méticuleux des processus et des technologies dans une optique de réduction de bilan énergétique.

Eco-Effectiveness

Höchste Aufmerksamkeit während des Planungs- und Produktionsverfahren: verantwortliche Nutzung der Ressourcen, sorgfältige Auswahl der Verfahren und Technologien im Hinblick auf eine ausgewogene Energiebilanz.

Eco-Effectiveness

Prestar la mayor atención al proceso de diseño y producción: uso responsable de los recursos y selección esmerada de los procesos y las tecnologías, en pos del balance energético.

Long term

Designing thinking to the long term through a careful planning of the entire product life cycle, promoting internal technical training using the experience accrued in sustainability research (LCA, analysis of technologies, of processes, etc.) developed with university research centres.

Long term

Concevoir à long terme au moyen d'une étude approfondie du cycle de vie du produit en favorisant la formation technique interne et en utilisant les expériences acquises dans le cadre des recherches sur la durabilité (LCA, analyse des technologies, des processus etc.) développées avec des centres de recherche universitaires.

Long term

Die Entwicklung der Produkte erfolgt unter Berücksichtigung des gesamten Lebenszyklus eines Produkts. Die aus der Zusammenarbeit mit Universitäten und Forschungszentren gewonnenen Erkenntnisse (LCA, Technologie- und Verfahrensanalyse etc.) werden den Mitarbeitern im Rahmen interner Schulungen vermittelt.

Long term

Diseñar con miras a una larga vida útil, proyectando atentamente todo el ciclo de vida del producto, fomentando la formación técnica interna y sacando partido de la totalidad de la experiencia atesorada, en el marco de la investigación en materia de sostenibilidad (LCA y análisis de las tecnologías, los procesos, etc.), que Artemide desarrolla en colaboración con centros de investigación universitarios.

Responsible Consumption

Spreading culture and offer tools for an informed choice (TCO, LENI) and a rational use of light in terms of energy saving and affordability

Responsible Consumption

Transmettre la culture et offrir des instruments pour un choix conscient (TCO, LENI) et un emploi raisonné de la lumière, en la qualifiant en termes d'économies d'énergie.

Responsible Consumption

Verbreitung dieser Kultur sowie die Kommunikation von Instrumenten (TCO, LENI). Rationale Verwendung von Licht im Hinblick auf Energie- und Geldeinsparung.

Responsible Consumption

Divulgar cultura y ofrecer herramientas de cara a una elección consciente (TCO y LENI) y a un uso razonado de la luz, calificándola en términos de ahorro energético y económico.

Quality

Quality is an essential choice for a more lasting relationship with the product and a crucial requirement in the search for authentic environmental innovation.

Quality

La qualité vue tel un droit fondamental pour un rapport plus long avec le produit, démarche indispensable pour la recherche d'une véritable innovation environnementale.

Quality

Qualität als ein grundlegendes Recht für eine dauerhafte Beziehung zum Produkt und als unabdingliche Voraussetzung für die Suche nach einer ehrlichen umweltbewussten Innovation.

Quality

La calidad, en cuanto derecho fundamental para dar vida a unas relaciones más duraderas con el producto, y como requisito indispensable para conseguir una auténtica innovación medioambiental.

Artemide. The Innovation

Ci troviamo in un momento in cui l'evoluzione della tecnica offre interessanti opportunità per lo sviluppo di generazioni di prodotti concettualmente nuovi. Tuttavia nel campo della luce oggi il progresso tecnologico non è più accessibile a tutti, è più complesso e richiede interpreti competenti: la creatività del designer deve necessariamente confrontarsi con un team specializzato. Per questo motivo Artemide si è dotata negli anni di una struttura di ricerca e sviluppo dove trovano posto le più diverse e specializzate competenze tecniche, laboratori accreditati e sistemi di qualità certificati.

Se da un lato l'innovazione si espleta nell'utilizzo dei LED e delle sorgenti a risparmio energetico, nell'uso di materiali e tecniche di produzione innovative, nell'attenzione all'efficienza e alla qualità della performance, dall'altro ricerca e innovazione tecnologica sono intese in senso umanistico con l'obiettivo di dare continuamente un contributo alla qualità della vita dell'uomo e del pianeta. Il progetto è per Artemide ricerca e cultura, parte dalla convergenza di una costante innovazione tecnologica e di un approccio di tipo antropologico. I numerosi brevetti di invenzione che accompagnano lo sviluppo dei prodotti Artemide e i riconoscimenti internazionali in campo di innovazione e sostenibilità testimoniano la sua tensione progettuale verso il futuro. L'innovazione è fatta di persone, della loro cultura e competenza ma soprattutto è data da una sperimentazione continua e da una visione condivisa. In quest'ottica anche il progetto per il nuovo campus e laboratorio di pensiero in fase di edificazione può essere visto come una testimonianza dello sforzo e della volontà di un'azienda di crescere secondo un approccio olistico e multidisciplinare, seguendo i principi della sostenibilità e dell'efficienza energetica, ponendo attenzione alla ricerca e alla sperimentazione.



COPERNICO

Innovation Patent n. MI2010A000610
It is a variable-geometry lighting fixture that uses specific mechanical joints. These joints have double function either for orientating the several sections of the fixture itself and to feed the power supply to all the LED branches.

SISIFO

Innovation Patent n. MI2010A001399
It is a lighting fixture with a radial light guide that generates a wide and homogeneous illuminating surface from a concentrated LED source.

PAD

Innovation Patent n. MI2010A000609
The Projector is based on LED technology with a system that integrates both optical and electronics. It integrates the active special power supply together with the optical system. The projector uses a thermal conductive back in heat exchange function and also uses a diffuser with integrated light emission lenses.

CATA

Innovation Patent n. MI2012A000605
The Projector based on LED technology is developed on the optical catadioptric principle with double collimating mirrors and light guiding system.

We find ourselves at a time when the evolution of technology offers interesting opportunities for the development of generations of conceptually new products. Nevertheless, in the field of light today technological progress is no longer accessible to everyone; it is more complex and requires skilful interpreters: the designer's creativity must necessarily be measured against that of a specialist team. For this reason, over the years Artemide has equipped itself with a research and development structure where there is space for the most diverse and specialist technical expertise, accredited laboratories and certified quality systems. On one hand, innovation is delivered in the use of LEDs and energy-saving light sources, by using materials and innovative production techniques with attention devoted to efficiency and the quality of the performance. On the other hand, research and technological innovation are understood in a humanistic sense with the aim of continually making a contribution towards the quality of life for people and the planet. Artemide's project is both research and culture, starting from the gathering of constant technological innovation and a cultural approach. The numerous patents for inventions that accompany the development of Artemide's products and the international awards in the field of innovation and sustainability are testament to the persistence of their projects for the future. Innovation is made of people, of their culture and skills, but above all it comes from continuous experimentation and from a shared vision. It is also with a view to this, that the project has been put in place for a new Campus and Laboratory of thought. This building is in the construction phase and can also be seen as an expression of the efforts and the desire of a company to grow according to a holistic and multi-disciplinary approach, pursuing the principles of sustainability and energy efficiency, with the emphasis on research and experimentation.

Nous vivons dans une époque où l'évolution de la technique offre d'intéressantes opportunités pour le développement de générations de produits conceptuellement nouveaux. Toutefois, aujourd'hui, dans le domaine de la lumière, le progrès technologique n'est plus accessible à tous, il est plus complexe et demande des interprètes compétents. La créativité du designer doit nécessairement se confronter avec une équipe spécialisée. C'est la raison pour laquelle Artemide s'est doté, au fil des années, d'une structure de recherche et de développement où les techniques les plus diverses et les plus spécialisées, des laboratoires accrédités et des systèmes de qualité certifiés trouvent leur place. D'une part, l'innovation s'exprime dans l'utilisation des leds et des sources à économie d'énergie, dans l'emploi de matériaux et de techniques de production novatrices, dans l'attention prêtée à l'efficacité et à la qualité de la performance. De l'autre, la recherche et l'innovation technologique sont entendues de façon humaniste, dans le but de contribuer continuellement à l'amélioration de la qualité de la vie de l'Homme et de la Terre. Pour Artemide, le projet est une affaire de recherche et de culture, il part de la convergence d'une innovation technologique constante et d'une approche de type anthropologique. Les nombreux brevets déposés qui accompagnent le développement des produits d'Artemide, les marques de reconnaissance internationale en matière d'innovation et de durabilité sont les témoins de sa tension conceptuelle vers le futur. L'innovation n'est pas seulement faite de personnes, de leur culture et de leurs compétences. Elle implique surtout une expérimentation continue et une vision partagée. Dans cette optique, même le projet pour le nouveau campus et atelier de conception qui est en cours de construction peut être interprété tel un témoignage de l'effort et de la volonté d'une entreprise de se développer. L'approche holistique et multidisciplinaire sont combinées aux principes de la durabilité et de l'efficacité énergétique, tout en mettant l'accent sur la recherche et l'expérimentation.

Wir befinden uns in einer Epoche, in der die technische Evolution interessante Möglichkeiten für die Entwicklung konzeptionell neuer Produkte bietet. Allerdings ist der technologische Fortschritt im Beleuchtungsbereich heute nicht mehr allen zugänglich. Er ist komplexer geworden und fordert kompetente Spezialisten. Die Kreativität des Designers muss sich notgedrungen mit der Arbeit des Spezialistenteams messen. Aus diesem Grund hat Artemide in den den vergangenen Jahren eine Forschungs- und Entwicklungsstruktur aufgebaut, in der verschiedene technische Fachkompetenzen, akkreditierte Labors und zertifizierte Qualitätssysteme Hand in Hand arbeiten. Kommt einerseits die Innovation in der Verwendung von LEDs und energiesparenden Lichtquellen, von innovativen Materialien und Produktionstechniken und in der Effizienz und der Leistungsqualität gewidmeten Aufmerksamkeit zum Ausdruck, wird andererseits Forschung und technologische Innovation im menschlichen Sinne groß geschrieben und zwar mit der Zielsetzung, stetig einen Beitrag zur Lebensqualität und für die Umwelt zu leisten. Ein Projekt ist für Artemide Forschung und Kultur, Teil der Annäherung einer konstanten technologischen Innovation an einen anthropologischen Ansatz. Die zahlreichen Patente, die Produktentwicklung von Artemide begleiten und die internationalen Anerkennungen in Bezug auf Innovation und Nachhaltigkeit stehen für seine zukunftsweisende Planungsausrichtung. Innovation ist zwar das Ergebnis menschlicher Arbeit, Kultur und Kompetenz, baut jedoch vor allem auf kontinuierliche Erprobung und eine geteilte Vision auf. So gesehen können auch der in Entstehung begriffene Campus und das Gedankenlabor als Zeugen des Engagements und des Willens des Unternehmens angesehen werden, ständig nach einem ganzheitlichen und multidisziplinären Ansatz zu streben, dabei die Grundsätze der Nachhaltigkeit und der Energieeffizienz nicht aus den Augen zu verlieren und besondere Aufmerksamkeit auf Forschung und Erprobung anzuwenden.

Estamos en una época en que la evolución de la técnica ofrece oportunidades interesantes a la hora de desarrollar generaciones de productos nuevos, desde el punto de vista conceptual. Sin embargo, en el sector de la luz, actualmente el progreso tecnológico no es accesible para todo el mundo. Es más complejo y requiere intérpretes competentes: la creatividad del diseñador debe dialogar indefectiblemente con un equipo de especialistas. Por esta razón, desde hace años, Artemide posee una estructura de I+D, donde tienen cabida las competencias técnicas más variadas y especializadas. Y a la misma se suman los laboratorios acreditados y los sistemas de calidad certificados de la Casa. Por un lado, en Artemide, la innovación se traduce en el uso de los LED y de las fuentes de luz de ahorro energético, en el uso de materiales y técnicas de producción innovadoras, en la atención que se le presta a la eficiencia y a la calidad de las prestaciones. Por otro, la investigación y la innovación tecnológica se interpreta en su vertiente humanística, con el objeto de poner siempre el propio grano de arena a favor de la calidad de vida del ser humano y el planeta. Para Artemide, el diseño es investigación y cultura y nace de la convergencia de la innovación tecnológica y de un planteamiento de tipo antropológico. Las numerosas patentes de invención que acompañan al desarrollo de los productos de Artemide y los reconocimientos internacionales, en el campo de la innovación y la sostenibilidad, dan fe de su andar hacia el futuro a través del diseño. La innovación es obra de las personas, de su cultura y su capacidad, pero, sobre todo, nace de una experimentación incesante y de una visión compartida. Desde este punto de vista, el proyecto en construcción del nuevo campus y laboratorio de ideas también se puede interpretar como una muestra del esfuerzo y la voluntad de la firma de crecer en base a un planteamiento holístico y multidisciplinar, con arreglo a los principios de sostenibilidad y eficiencia energética, prestando siempre atención a la investigación y a la experimentación.

Artemide. The Good Light

La luce, variando colore o temperatura, costruisce emozioni e relazioni. Le radiazioni luminose che raggiungono i nostri occhi vengono trasformate in impulsi elettrici e trasmesse, mediante il nervo ottico, al cervello. Da qui si origina una serie di input che vengono trasmessi a tutto l'organismo. In particolare, quando gli impulsi raggiungono l'ipotalamo, si determina un incremento della serotonina, neurotrasmettitore deputato al controllo del tono dell'umore. Quando gli impulsi raggiungono l'epifisi si assiste ad una riduzione della melatonina, ormone sensibile al ciclo giorno-notte. Conseguenza di tali reazioni neurofisiologiche è una variazione significativa del tono dell'umore in funzione della quantità e della qualità di luce a cui è esposto un individuo.

Progettare la luce significa andare oltre l'aspetto puramente funzionale dell'illuminazione e abbracciare una dimensione più ampia che faccia capo a una nuova attenzione per l'esperienza percettiva. La conoscenza e consapevolezza di Artemide su questo tema, legate alle ricerche sviluppate dagli anni 90' ad oggi con università, centri di ricerca, esperti di diverse discipline scientifiche (medicina, biologia, psicologia, antropologia) hanno portato allo sviluppo di sistemi di illuminazione innovativi.

Metamorfosi, A.I.s.o. e Tunable White sono sintesi tra innovazione tecnologica e attenzione all'uomo e ai suoi bisogni psicologici e fisiologici. Non sono prodotti ma mezzi per creare scenari luminosi variabili con cui interagire e vivere il rapporto con la luce in modo nuovo, più diretto e consapevole.

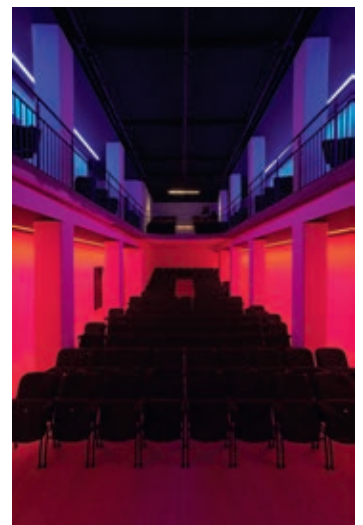

By changing colour or temperature, light builds emotions and relationships. The light radiations reaching our eyes are transformed into electric impulses and transmitted to the brain via the optic nerve. From here a series of inputs are originated and transmitted to the entire body. In particular, when the impulses reach the hypothalamus they determine an increase in serotonin, a neurotransmitter that controls moods. When the impulses reach the epiphysis we have a reduction in melatonin, a hormone sensitive to the day-night cycle. The consequence of these neurophysiological reactions is a significant mood swing depending on the quantity and quality of light to which an individual is exposed. Designing light for people means outreaching the purely functional aspects of lighting and embracing a broader dimension, with a new attention towards perceptive experience. Artemide's knowledge and awareness on this topic led to the implementation of innovative lighting systems. This is associated with the research developed from the 1990s to the present day with universities, research centres and experts in various scientific disciplines (medicine, biology, psychology, anthropology). Metamorfosi, A.I.s.o. and Tunable White combine technological innovation and attention to people and their psychological needs. They are not products, but ways of creating tunable light settings in order to experience the relationship with light through a conscious and direct interaction.

En changeant de couleur ou de température, la lumière participe aux émotions et aux relations. Les radiations lumineuses qui atteignent nos yeux sont transformées en impulsions électriques et transmises au cerveau par le nerf optique. Le cerveau émet alors une série d'ordres qui sont transmis à tout l'organisme. En particulier, quand les impulsions atteignent l'hypothalamus, elles provoquent une augmentation de la sérotonine, un neurotransmetteur voué au contrôle de l'humeur. Quand les impulsions atteignent l'épiphyse, on assiste à une réduction de la mélatonine, une hormone sensible au cycle jour-nuit. La conséquence de ces réactions neurophysiologiques est une variation significative de l'humeur en fonction de la quantité et de la qualité de lumière à laquelle un individu est exposé. Concevoir la lumière pour l'homme c'est aller au-delà de l'aspect purement fonctionnel de l'éclairage et appréhender une dimension plus ample qui aboutit à une nouvelle attention pour l'expérience perceptive. Liées aux recherches réalisées depuis les années 90 avec les universités, les centres de recherche et les experts de différentes disciplines scientifiques (médecine, biologie, psychologie, anthropologie), la connaissance et la conscience dont Artemide fait preuve sur cette question ont abouti au développement de systèmes d'éclairage novateurs. Metamorfosi, A.I.s.o. et Tunable White constituent une synthèse entre l'innovation technologique et l'attention prêtée à l'homme et à ses besoins psychologiques et physiologiques. Ce ne sont pas des produits mais des moyens de créer des cadres lumineux variables, avec lesquels il est possible d'interagir et de vivre le rapport avec la lumière d'une manière nouvelle, plus directe et consciente.

Farb- oder Temperaturvariationen des Lichts beeinflussen Gefühle und Beziehungen. Die Lichtstrahlen, die auf unsere Augen treffen, werden in elektrische Impulse verwandelt und über den Sehnerv an unser Gehirn weitergeleitet. Hier bildet sich eine Reihe an Inputs für den gesamten Organismus. Erreichen diese Impulse den Hypothalamus, so ein Anstieg von Serotonin zu verzeichnen, diesem Neurotransmitter, der für die Stimmungslage verantwortlich ist. Erreichen die Impulse die Zirbeldrüse, kann eine Abnahme von Melatonin beobachtet werden, ein Hormon, das den Tag-Nacht-Rhythmus regelt. Eine Folge dieser neurophysiologischen Reaktionen ist eine bedeutsame Schwankung der Stimmungslage je nach Quantität und Qualität des Lichts, dem ein Individuum ausgesetzt ist. Licht für den Menschen zu planen bedeutet daher, über den rein funktionellen Aspekt einer Beleuchtung hinauszugehen und eine weitreichendere Dimension zu berücksichtigen, die nach einer neuen Aufmerksamkeit für die Gefühlserfahrung verlangt. Das Wissen und das Bewusstsein von Artemide zu diesem Thema sowie mit den seit den 90er Jahren bis heute in Zusammenarbeit mit Universitäten, Forschungszentren, verschiedenen Fachwissenschaftlern (Medizinern, Biologen, Psychologen, Anthropologen) getätigten Forschungsarbeiten haben zur Entwicklung innovativer Beleuchtungssysteme geführt. Metamorfosi, A.I.s.o. und Tunable White sind das Ergebnis technologischer Innovation und der dem Menschen und seinen psychologischen und physiologischen Bedürfnissen zugewandten Aufmerksamkeit. Es sind keine Produkte, sondern Mittel zur Schaffung variabler Lichtszenarien, mit denen interagiert und die Beziehung zum Licht neu, direkter und bewusster ausgelebt werden kann.

La luz, al variar de color o de temperatura, construye emociones y relaciones. Cuando las radiaciones luminosas llegan a nuestros ojos, se transforman en impulsos eléctricos. A continuación, éstos se transmiten al cerebro a través del nervio óptico. Aquí tiene origen una serie de impulsos que se transmiten a todo el organismo. En particular, cuando dichos impulsos llegan al hipotálamo, se determina un aumento de la serotonina, el neurotransmisor que desempeña un papel clave en el control del tono del humor. Cuando los impulsos llegan a la epífisis, disminuye el nivel de melatonina, una hormona sensible al alternarse del día y la noche. A consecuencia de dichas reacciones neurofisiológicas, se produce una variación importante del humor, en función de la cantidad y la calidad de la luz a la que el ser humano se ve expuesto. Diseñar la luz para el ser humano significa dejar atrás el aspecto meramente funcional de la iluminación y abrazar una nueva dimensión más amplia y atenta a la experiencia perceptiva. Los conocimientos de Artemide en la materia, al igual que su concienciación, están vinculados a las investigaciones que la firma viene llevando a cabo, desde los años 90 hasta la fecha, en colaboración con universidades, centros de investigación y expertos en distintas ramas de la ciencia (medicina, biología, psicología y antropología). Gracias a los mismos, ha sido posible desarrollar sistemas de iluminación innovadores. Metamorfosi, A.I.s.o. y Tunable White son la síntesis entre la innovación tecnológica y la atención que la firma presta al ser humano y a sus necesidades psicológicas y fisiológicas. No son productos. Son medios para crear escenarios luminosos variables, con los que es posible interactuar y vivir las relaciones con la luz de una manera nueva, más directa y consciente.

Artemide. The Network

● European and North American production facilities

- 1 Artemide SpA, Pregnana Milanese - Milan (IT)
- 2 Artemide Architectural Sas - Saint Florent (FR)
- 3 Vetrofond Srl, Casale sul Sile - Venice (IT)
- 4 A&A - Paks (HU)
- 5 Sklárna Janštejn, s.r.o. - Horní Dubenky (CZ)
- 6 Artemide Manufacturing North America Quebec - Montreal (CA)

● Worldwide Subsidiaries

- 7 Artemide Italia, Milan (IT)
- 8 Artemide Illuminazione, Zurich (CH)
- 9 Artemide Handelsgesellschaft, Vienna (AT)
- 10 Artemide France, Paris (FR)
- 11 Artemide GmbH, Fröndenberg (DE)
- 12 Artemide SA, Barcelona (SP)
- 13 Horas, Ruisbroek (BE)
- 14 Artemide GB, London (UK)
- 15 Artemide Scandinavia, Hellerup (DK)
- 16 Foton, Lisbon (PT)
- 17 Artemide Hellas, Athens (GR)
- 18 Artemide Agency, Moscow (RU)
- 19 Artemide Inc, Hicksville - New York (US)
- 20 Artemide Ltée, Quebec -Montreal (CA)
- 21 Scultura Luminosa, Mexico City (MX)
- 22 Artemide Brasil, São Paulo (BR)
- 23 Edimetra, Buenos Aires (AR)
- 24 Artemide Middle East, Dubai (UA)
- 25 Artemide HK Ltd, Hong Kong (HK)
- 26 Artemide Trading Shanghai, Shanghai (CN)
- 27 Artemide Japan, Tokyo (JP)
- 28 T&S Trading Ltd, Seoul, (ROK)
- 29 Artemide Lighting India, Mumbai (IN)
- 30 Ornare Imports, Adelaide (AU)



Artemide da sempre sviluppa soluzioni di luce che integrano le tematiche legate a spazi architettonici e spazi di vita nel segno della sostenibilità, condividendo competenza e know how con architetti e lighting planner.

Artemide è sensibile non solo alla progettazione a favore dell'uomo, ma anche al rispetto delle risorse del Pianeta, offrendo un nuovo servizio relativo al tema del risparmio energetico e dell'impatto economico del progetto.

Infatti attraverso **Artemide TCO - Total Cost Ownership** - uno strumento di calcolo di ultima generazione, è possibile proporre oggi soluzioni di controllo della luce e degli impianti che garantiscano un consumo mirato delle risorse energetiche, partendo da stime puntuali dei costi di installazione e di utilizzo degli apparecchi.

Con i suoi **Lighting Consultancy Center** worldwide Artemide offre un servizio completo sul territorio di supporto al Lighting Engineering Project, attivando un costante dialogo con i suoi Partner.

Inoltre è possibile accedere al servizio di consulenza online attraverso il sito web **artemide.com**, consultare i dati tecnici ed effettuare il download di tutti gli strumenti necessari per eseguire in autonomia il proprio progetto luce.

Artemide develops lighting solutions integrating architectural and living spaces, always with a keen eye on sustainability, sharing expertise and knowledge with architects and lighting planners.

Artemide is sensitive not only to the needs of individuals, but also to the environment, offering a new service aimed at energy saving and to help in reducing costs.

This service is called Artemide TCO - Total Cost Ownership and it is one of the latest generation calculation tools. Starting from precise estimates of installation and usage costs, it offers solutions for controlling equipment and installations requiring a targeted consumption of energy.

With its Lighting Consultancy Centres worldwide, Artemide offers customers a complete service to support lighting engineering plans, beginning a constant dialogue with its partners.

Lighting professionals can download the Dialux and Luxart calculation programs, Eulumdat data, 2D and 3D images of products from the artemide.com website, together with all the technical information needed to implement your own lighting project.

Depuis toujours Artemide développe des solutions d'éclairage permettant d'intégrer les thématiques architecturales et propres aux espaces de vie à celles de l'éco-responsabilité et cela grâce à un partage continu de ses compétences et de son savoir faire avec les architectes et les lighting planners.

Artemide n'est pas uniquement sensible aux besoins de l'Homme mais elle est également attentive au respect des ressources de la Planète: cette sensibilité se traduit dans la mise à disposition d'un service relatif à l'épargne énergétique et à l'impact économique du projet. En effet par l'intermédiaire de **Artemide TCO - Total Cost Ownership** - un instrument de calcul de dernière génération, Artemide propose des solutions de gestion de l'éclairage et des implantations capables de garantir des consommations ciblées des ressources énergétiques grâce à des estimations ponctuelles des coûts d'installation et d'utilisation des appareils.

Par le biais de ses **Lighting Consultancy Center** dans le monde entier, Artemide propose un service complet de support sur le territoire au Lighting Engineering Project en garantissant ainsi un dialogue constant avec ses partenaires.

De plus un service de consultation est disponible en ligne sur le site **artemide.com**: il est ainsi possible de prendre connaissance des données techniques ainsi que les 2D et 3D et d'effectuer le téléchargement de l'ensemble des instruments nécessaires afin de réaliser son propre projet d'éclairage en toute autonomie.

In einem architektonischen Projekt spielt Licht eine wesentliche Rolle. Planer setzen sich mit spezifischen und realen Anforderungen an die Beleuchtung auseinander.

Artemide arbeitet seit Beginn mit Architekten und Lichtplaner zusammen und unterstützt sie hierbei mit langjähriger Expertise. Hierbei ist das Thema Energieeinsparung von besonderer Bedeutung.

Die eigens von Artemide entwickelte Software **Artemide TCO - Total Cost Ownership** - bietet Steuerungslösungen, die einen gezielten Verbrauch der energetischen Ressourcen ermöglichen.

Mit seinen **Light-Consultancy-Centern** bietet Artemide seinen Kunden einen kompletten Service, der auch die Unterstützung im Bereich Lichtplanung umfasst. Dies repräsentiert die finale Phase eines komplexen Verfahrens, das sich durch den konstanten Dialog zwischen Artemide Beratern, dem für das Projekt verantwortlichen Architekten sowie dem Lichtplaner auszeichnet.

Auf unserer Internetseite **artemide.com** erhalten Sie per Download die Lichtberechnungsprogramme Dialux und Luxart, Eulumdat-Dateien, 2D- und 3D Abbildungen der Produkte sowie alle weiteren erforderlichen technischen Informationen, um Ihr Beleuchtungsprojekt selbstständig erstellen zu können.

$$TCO = \text{€}_{\text{system}} + \text{€}_{\text{maintenance}} + (W_{l,t} + W_{p,t}) \cdot \text{€}_{\text{kWh}}$$

TCO: Total Cost Ownership

$W_{l,t}$: absorbed energy with lamps on $P_n \cdot t_d \cdot (F_d \cdot F_o \cdot F_c) + P_n \cdot t_n \cdot (F_o \cdot F_c)$ [kWh]

$W_{p,t}$: absorbed parasitic energy with lamps off $P_{pc} \cdot [t - (t_d + t_n)] + P_{em} \cdot t_e$ [kWh]

Artemide desde siempre desarrolla soluciones de luz que integran temáticas legadas a espacios arquitectónicos y espacios de vida que tengan que ver con la sostenibilidad, compartiendo competencia y know how con los arquitectos y los lighting planner.

Artemide es sensible no sólo en el diseño a favor del hombre, sino también en el respeto de los recursos del Planeta, ofreciendo un nuevo servicio que se refiere al tema del ahorro energético y el impacto económico del proyecto. De hecho a través del **Artemide TCO - Total Cost Ownership** - un instrumento de cálculo de última generación, ahora es posible proponer soluciones de control de la luz y de sistemas que garanticen un consumo selectivo de los recursos energéticos, a partir de las estimaciones puntuales de los costos de instalación y operación de los equipos.

Con sus 55 **Lighting Consultancy Center** en el mundo, Artemide ofrece un servicio completo en el área de soporte al Proyecto de Ingeniería de iluminación, lo que permite un diálogo constante con sus Partners.

También se puede acceder al servicio de consulta en línea a través de la web **artemide.com**, consultar los datos técnicos y descargar todas las herramientas necesarias para poder trabajar de forma autónoma en el propio proyecto de iluminación.

Con 3 linee di prodotti - Artemide Design, Artemide Architectural Indoor & Outdoor e Danese - Artemide offre una gamma completa di prodotti per l'illuminazione, in grado di risolvere le esigenze illuminotecniche legate a tutti i tipi di applicazione, indoor e outdoor.

With 3 product lines - Artemide Design, Artemide Architectural Indoor & Outdoor and Danese - Artemide offers a complete range of lighting equipment. These can be integrated to resolve the lighting engineering needs with all types of application, both indoor and outdoor.

Avec ses 3 lignes de produits - Artemide Design, Artemide Architectural Indoor & Outdoor et Danese - Artemide offre une gamme d'appareils d'éclairage complète. En les intégrant, nous sommes en mesure de répondre à toutes les exigences qui se posent à tous les types d'application de l'éclairage technique, tant en intérieur qu'en extérieur.

Mit seinen 3 Produktlinien - Artemide Design, Artemide Architectural Indoor & Outdoor und Danese - bietet Artemide eine komplette Palette an Beleuchtungsgeräten. Integriert man sie untereinander, sind sie in der Lage, allen Beleuchtungsanforderungen im Innen- und Außenbereich gerecht zu werden.

Con sus tres líneas de productos - Artemide Design, Artemide Architectural Indoor & Outdoor y Danese - Artemide ofrece una gama completa de aparatos de iluminación. Integrándolos es capaz de resolver la demanda luminotécnica relacionada con todos los tipos de aplicación, ya sea de interiores o de exteriores.

Attraverso il sito artemide.com e le linee telefoniche dedicate, Artemide garantisce un puntuale servizio customer care di assistenza pre e post vendita. Inoltre, iscrivendosi alla newsletter è possibile essere costantemente aggiornati sui nuovi prodotti, eventi e progetti.

Via the website artemide.com and the dedicated telephone lines, Artemide guarantees a prompt customer care service both pre- and post-sale. Furthermore, by signing up for the newsletter it is possible to be constantly updated on new products, events and projects.

Grâce au site artemide.com et aux lignes téléphoniques dédiées, Artemide garantit un service d'assistance à la clientèle, avant et après-vente. En outre, l'inscription à la newsletter permet d'être constamment informé sur les nouveaux produits, les événements et les projets.

Über die Site artemide.com und die dedizierten Telefonlinien gewährleistet Artemide einen pünktlichen Kundendienstservice vor und nach dem Verkauf. Durch Anmeldung ist es auch möglich, mit dem Newsletter konstant über neue Produkte, Events und Projekte auf dem Laufenden gehalten zu werden.

A través de su página Web artemide.com y de sus líneas telefónicas con dedicación exclusiva, Artemide garantiza un servicio de atención al cliente puntual, tanto de preventa como de posventa. Además, dándose de alta en nuestro boletín, es posible estar siempre al día sobre los nuevos productos, eventos y trabajos.

artemide.com
info@artemide.com

5 YEARS

WARRANTY

Artemide®

Artemide è da sempre sinonimo di prodotti di alta qualità. A conferma di ciò, siamo lieti di informare che a partire dal 1 aprile 2015, sarà offerta a tutti i suoi utilizzatori finali (solo utilizzatori privati), in tutto il mondo, una garanzia gratuita estesa a 5 anni, previa corretta registrazione online del prodotto entro i 2 mesi dalla data di acquisto.

Le condizioni principali della garanzia 5 anni, sono le seguenti:

- Essere un utilizzatore finale (acquirente privato);
- Aver acquistato il prodotto Artemide dopo il 1 aprile 2015;
- Aver registrato il prodotto on-line entro 2 mesi dalla data di acquisto;
- Il prodotto acquistato deve essere nuovo (non di seconda mano);
- Essere il primo acquirente del prodotto (la garanzia non è trasferibile).

La suddetta garanzia, correttamente attivata e azionata, conferirà al cliente privato il diritto di ottenere da Artemide la riparazione o la sostituzione gratuita del prodotto riconosciuto affetto da difettosità del materiale o vizio di produzione così come previsto dalle condizioni di validità della garanzia.

Ulteriori informazioni sono reperibili sul sito:
cloud.artemide.com/5-years-warranty

Artemide has always provided high quality products. As a result, we are glad to inform you that from April 1st 2015 we will offer to all our end users worldwide (private consumers only) a free 5-year extended warranty, valid only if the product is successfully registered online within two months from the date of purchase.

Artemide a toujours été synonyme de produits de grande qualité. Confirmant cet état de fait, nous sommes heureux de vous informer qu'à compter du 1er Avril 2015, Artemide offre à ses utilisateurs finaux (uniquement les particuliers) dans le monde entier une garantie étendue à 5 ans, si le produit est enregistré avec succès dans les deux mois suivants la date d'achat.

Artemide ist seit jeher Synonym für hochwertige Produkte. Als Zeugnis unserer Qualität freuen wir uns, ab dem 1. April 2015 allen Endverbraucher (nur Konsumenten) weltweit eine kostenlose Garantie mit einer Laufzeit von 5 Jahren anbieten zu können. Voraussetzung hierfür ist eine erfolgreiche Online-Registrierung des Produkts innerhalb von 2 Monaten ab Kaufdatum.

Artemide es desde siempre sinónimo de productos de calidad. Como confirmación de esto, nos complace informarle que a partir del 1 de abril 2015, se ofrecerá a todos los usuarios finales (sólo consumidores privados) en todo el mundo una garantía extendida gratuita de 5 años, si el producto se ha registrado con éxito dentro de los dos meses posteriores a la fecha de compra.

Conditions for the 5-year extended warranty are as follows:

- Being an end user (private consumer);
- Purchasing the Artemide product after April 1st 2015;
- Registering the product online within 2 months from the date of purchase;
- The product must be new (not second-hand);
- Being the first owner of the product (the warranty is not transferable).

Les conditions de cette garantie de 5 ans sont principalement les suivantes:

- Être un particulier (consommation privée);
- Avoir acheté le produit Artemide après le 1er Avril 2015;
- Avoir enregistré le produit en ligne dans les deux mois suivants la date d'achat;
- Le produit doit être neuf (les produits d'occasion ne sont pas considérés);
- Être le premier propriétaire du produit (la garantie n'est pas cessible).

Die wichtigsten Bedingungen für die 5-Jahres-Garantie sind:

- Sie sind Endverbraucher (privater Konsument)
- Sie haben das Artemide-Produkt nach dem 1. April 2015 erworben
- Sie haben das Produkt innerhalb von 2 Monaten ab Kaufdatum online registriert
- Es handelt sich um ein neues Produkt (nicht aus zweiter Hand)
- Sie sind Erstkäufer des Produkts (die Garantie ist nicht übertragbar).

Las condiciones principales de la garantía de 5 años, son las siguientes:

- Ser consumidor final (consumo privado);
- Haber comprado el producto Artemide después del 1º abril 2015;
- Haber registrado el producto on-line en los 2 meses posteriores a la compra;
- El producto que ha comprado tiene que ser nuevo (no de segunda mano);
- Ser el primer propietario del producto (la garantía no es transferible).

Following successful online activation and claim, the extended warranty will entitle the private customer to a free repair or replacement when the product is determined to be faulty due to manufacturing defect, as stated on its terms and conditions.

La garantie mentionnée ci-dessus, si elle est réclamée et activée avec succès en ligne, permettra au client d'avoir la réparation ou le remplacement de son produit Artemide gratuitement par Artemide après constatation d'un défaut de fabrication ou de matériel comme prévu dans les termes de cette garantie.

Nach erfolgreicher Registrierung und Reklamierung im Schadensfall hat der Verbraucher im Rahmen der Garantiebedingungen Anspruch auf kostenlose Reparatur oder Ersatz sofern es sich um Material- oder Herstellungsmängel handelt.

La garantía mencionada anteriormente, activada correctamente y accionada, dará derecho al cliente a obtener por parte de Artemide la reparación o la sustitución gratuita del producto del que se reconoce un defecto del material o de fabricación, conforme a lo dispuesto por los términos de la garantía.

For further information please go to: cloud.artemide.com/5-years-warranty

Pour plus d'informations aller sur: cloud.artemide.com/5-years-warranty

Weitere Informationen finden Sie unter: cloud.artemide.com/5-years-warranty.

Para más información por favor visite: cloud.artemide.com/5-years-warranty

IN-EI
ISSEY MIYAKE

Lampade da tavolo
Table lamps
Lampes de table
Tischleuchten
Lámparas de sobre-mesa



38

60

FUKUROU sosp.	51	Aqua Cil tavolo	122
FUKUROU terra	50	Castore tavolo	126
HAKOFUGU	54	Choose tavolo	121
HAKOFUGU micro	55	Dalù	132
HAKOFUGU micro stelo	55	Demetra	76
HOSHIGAME	43	Dioscuro tavolo	124
KATATSUMURI	59	Empatia	62
MENDORI	44	Equilibrist	100
MENDORI mini	45	Fiamma tavolo	116
MINOMUSHI sosp.	49	Halo	110
MINOMUSHI terra	48	Ipparco	108
MOGURA	46	Itis	112
MOGURA mini	46	Laguna	70
TATSUNO-OTOSHIGO	52	Logico micro tavolo	128
WUNI	58	Logico mini tavolo	128
YADOKARI	42	Logico tavolo	128
		Lotek	106
		Melampo notte	120
		Melampo tavolo	120
		Meteorite	66
		Meteorite stelo	66
		Miconos tavolo	131
		Nessino	133
		Null Vector tavolo	118
		Objective	104
		One line	114
		Onfale	130
		Sisifo	72
		Talak tavolo	115
		Tizio	82
		Tizio 35	82
		Tizio Led	82
		Tizio micro	82
		Tizio X30	82
		Tolomeo	86
		Tolomeo basculante tavolo	98
		Tolomeo mega tavolo	99
		Tolomeo micro	86
		Tolomeo midi	86
		Tolomeo mini	86
		Tolomeo TW	86

Lampade da terra

Floor lamps
Lampadaires
Stehleuchten
Lámparas de pie



134

Lampade da parete

Wall lamps
Appliques
Wandleuchten
Apliques



202

Lampade da soffitto

Ceiling lamps
Plafonniers
Deckenleuchten
Pláfones



204

Lampade a sospensione

Suspension lamps
Suspensions
Pendelleuchten
Suspensiones



324

Master's pieces





416

90°	182	After dark parete/soffitto	240	After dark parete/soffitto	240	Aggregato sosp.	346	Alfa	418
Alcatraz	179	Altrove 600 parete/soffitto	285	Altrove 600 parete/soffitto	285	Aggregato sosp. saliscendi / decentrato	346	Boalum	425
Aqua Cil terra	164	Altrove TW parete/soffitto	284	Altrove TW parete/soffitto	284	Altrove 600 sosp.	357	Callimaco	426
Cabildo terra	165	Altrove parete/soffitto	282	Altrove parete/soffitto	282	Altrove TW sosp.	356	Chimera	432
Cadmo	140	Cabildo parete	223	Aqua Cil soffitto	312	Altrove sosp.	354	Eclisse	419
Castore terra	174	Cadmo parete	238	Botanic rain	318	Aqua Cil sosp.	396	Fato	422
Choose mega terra	193	Choose parete	262	Cosmic Angel soffitto	289	Cabildo sosp.	397	Genesy	436
Choose terra	193	Copernico parete	228	Cosmic Landscape parete/soffitto	290	Calenda	410	Lesbo	420
Cosmic Leaf terra	191	Cosmic Angel parete	288	Cosmic Leaf soffitto	316	Castore calice sosp.	380	Mezzachimera	432
Demetra lettura	156	Cosmic Landscape parete/soffitto	290	Cosmic Rotation parete/soffitto	291	Castore sosp.	378	Montjuic	435
Doride	166	Cosmic Rotation parete/soffitto	291	Dioscuri parete/soffitto	278	Choose mega sosp.	404	Nesso	421
Empatia 26 terra	168	Cuma	220	Droplet mini parete/soffitto	286	Choose sosp.	404	Noto	444
Empirico terra	190	Demetra faretto	230	Droplet soffitto	313	Copernico 500 sosp.	340	Pantalica parete	442
Fiamma lettura	154	Demetra parete	230	Edge parete/soffitto	292	Copernico sosp.	338	Pantalica sosp.	442
Florensis terra	144	Dinarco	242	Empatia parete/soffitto	272	Cosmic Angel sosp.	394	Patroclo	424
Ilio	136	Dioscuri parete/soffitto	278	Float circolare soffitto	296	Cosmic Landscape sosp.	407	Pausania	428
Illiria	180	Droplet mini parete/soffitto	286	Float lineare soffitto	296	Cosmic Rotation sosp.	406	Pipe parete/soffitto	438
Laguna terra	172	Edge parete/soffitto	292	Groupage	294	Droplet sosp.	388	Pipe sospensione	438
Logico terra	176	Empatia parete/soffitto	272	Iosif	304	Edge sosp.	381	Pipe terra	438
Megaron terra	160	Eurialo	229	Laguna soffitto	276	Empatia sosp.	372	Prometeo	434
Melampo mega terra	192	Fiamma parete	234	Led Net circle soffitto	301	Empirico sosp.	408	Shogun tavolo	430
Melampo terra	192	Flashit	250	Led Net line soffitto	300	Empirico system	408		
Metacolor	184	Florensis parete	224	Logico micro/mini/nano soffitto	320	Fiamma sosp.	348		
Meteorite 35 terra	170	Jet/Jet base	265	Logico soffitto	320	Float circolare sosp.	370		
Miconos terra	178	Logico mini/micro parete	270	Lunarphase	246	Float lineare sosp.	370		
Mimesi	146	Logico parete	270	Mercury mini soffitto	314	Laguna sosp.	376		
New Nature	148	Lunarphase	246	Mercury soffitto	314	Led Net circle sosp.	344		
Objective lettura	158	Melampo parete	260	Meteorite parete/soffitto	274	Led Net line sosp.	342		
Reall terra	150	Melete	222	Miconos soffitto	280	Logico micro/mini/nano sosp.	384		
Reeds	188	Mesmeri	206	Nebula	244	Logico sosp.	384		
Solium	142	Meteorite parete/soffitto	274	Nur gloss mini soffitto	308	Mercury mini sosp.	390		
Talak lettura	162	Miconos parete	280	Nur gloss soffitto	308	Mercury sosp.	390		
Tizio supporto terra	161	Microsurf	216	Nur mini soffitto	306	Meteorite sosp.	374		
Tolomeo basculante lettura	198	Nebula	244	Nur soffitto	306	Miconos sosp.	382		
Tolomeo basculante terra	198	Objective parete	236	Pantarei	269	Mouette mini	412		
Tolomeo lettura	196	Pantarei	269	Pirce mini soffitto	298	Mouette simm./asimm.	412		
Tolomeo mega terra	194	Pirce parete/micro parete	210	Pirce soffitto	298	Nuboli	411		
Tolomeo micro terra	196	Platea	243	Skydro	310	Null vector	350		
Tolomeo terra	196	Rea	218	Teti	267	Nur	362		
Tolomeo XXL	200	Reall parete	226			Nur 1618	362		
Yang	186	Robbia	266			Nur gloss	366		
		Skopos	264			Nur gloss mini	366		
		Talak parete	248			Nur mini	362		
		Talo parete	212			Pirce mini/micro sosp.	330		
		Talo 90/120/150/180/240 parete	214			Pirce sosp.	330		
		Telefo	268			Scopas	336		
		Teti	267			Space Cloud	334		
		Tolomeo basculante parete	256			Talo sosp.	368		
		Tolomeo braccio	252			Tian Xia 500 Led	360		
		Tolomeo faretto	254			Tian Xia metamorfosi	358		
		Tolomeo mega parete	258			Tolomeo mega sosp.	402		
		Tolomeo micro faretto	254			Tolomeo sosp. due bracci alluminio	398		
		Tolomeo micro/mini/midi parete	252			Tolomeo sosp. due bracci pergamena	399		
		Tolomeo pinza/micro pinza	255			Tolomeo sosp. decetrata	400		
		Tolomeo parete/TW	252			Unterlinden	326		
		Tolomeo parete diffusore	259						

 **After dark**  240 240

 **Aggregato**   346

 **Alcatraz**   179

 **Alfa**  418

 **Altrove**   282 282 354

Altrove 600  285 285 357

Altrove **TW**  284 284 356

 **Aqua Cil**  122 164 312 396

 **Boalum**  425 425

 **Botanic rain**  318

 **Cabildo**   165 223 397

 **Cadmo**   140 238



 **Calenda**  410



 **Callimaco**   426

 **Castore 14**   126 378



 **Castore 25**   126 378

 **Castore 35**   126 174 378

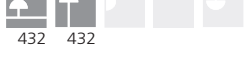

 **Castore 42**   126 174 378

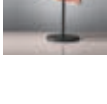
 **Chimera**  432

Mezzachimera  432 432

 **Choose**  121 193 262 404



Choose mega  193 404

 **Copernico**   228 338



Copernico 500  340



 **Cosmic Angel**  288 289 394

 **Cosmic Landscape**   290 290 407

 **Cosmic Leaf**   191 316



 **Cosmic rotation**  291 291 406

 Cuma 10  220

Cuma 20   220

Cuma 26  220

 Dalù   132

 Demetra   76 156 230

Demetra faretto
Demetra parete  230

 Dinarco  242

 Dioscuri 14   124 278 278

Dioscuri 25   124 278 278

Dioscuri 35   124 278 278

Dioscuri 42   124 278 278

 Doride   166

 Droplet  313 388

Droplet mini  286 286

 Eclisse   419

 Edge 21  292 292

Edge 30  292 292 381

 Empatia 16  62 272 272 372

Empatia 26  62 168 272 272 372

Empatia 36   62 272 272 372

 Empirico  190 408

Empirico system  408

 Equilibrist   100

 Eurialo  229

 Fato   422

 Fiamma  116 154 234 348

 Flashit  250

 Float circolare   296 370

Float lineare  296 370

 Florensis   144 224

 Fukurou  50 51



Genesy

436

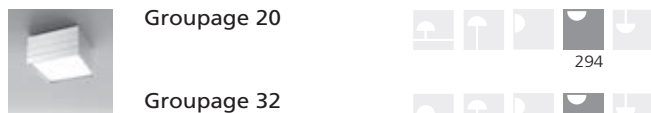

Groupage 20

294

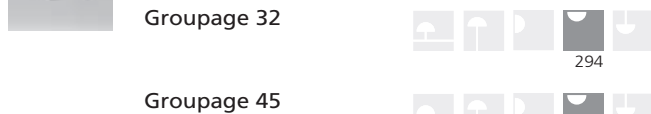

Groupage 32

294

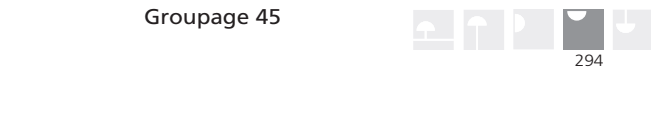

Groupage 45

294



Hakofugu

54

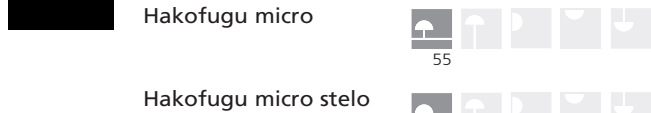

Hakofugu micro

55

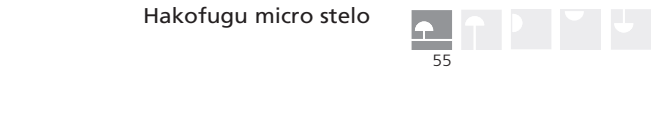

Hakofugu micro stelo

55



Halo

110



Hoshigame

43



Ilio

136



Illiria

180



Iosif

304



Ipparco

108



Itis

112



Jet

265



Jet base

265

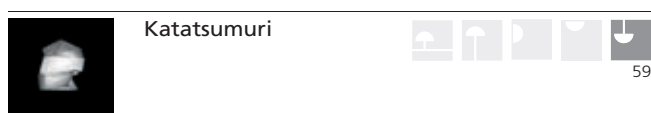

Katatsumuri

59



Laguna 16

70

172

276

376



Laguna 26

70

172

276

376

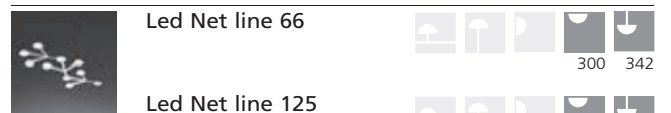

Laguna 37

70

172

276

376



Led Net line 66

300

342



Led Net line 125

300

342



Led Net circle

301

344

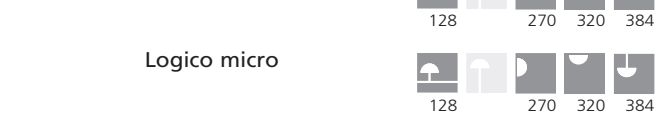

Lesbo

420



Logico

128

176

270

320

384



Logico mini

128

270

320

384



Logico micro

128

270

320

384



Logico nano

320

384

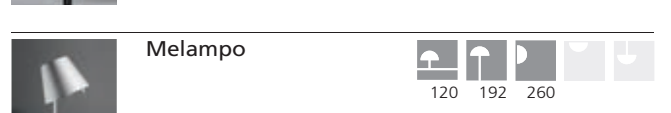

Lotek

106

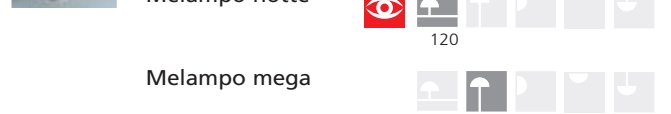

Lunarphase 450

246

246

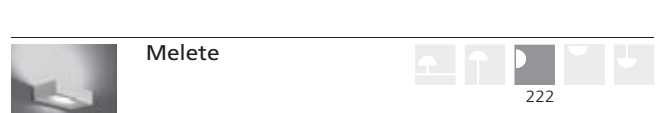

Lunarphase 600

246

246



Megaron

160



Melampo

120

192

260

Melampo notte



120

Melampo mega



192

Melete

222

 **Mendori**   44

Mendori mini  45

 **Mercury**   314 390

Mercury mini  314 390

 **Mesmeri**   206

 **Metacolor**  184

 **Meteorite 15**  66 274 274 374

Meteorite 35   66 170 274 274 374

Meteorite stelo 15  66



Meteorite stelo 35   66

 **Miconos**  131 178 280 280 382

 **Microsurf**  216



 **Mimesi**   146

 **Minomushi**  48 49

 **Mogura**  46

Mogura mini  46

 **Montjuic**  435

 **Mouette simmetrica**  412

Mouette asimmetrica  412

Mouette mini   412

 **Nebula**   244 244

 **Nesso**  421

Nessino   133

 **New nature**   148

 **Noto**  444

 **Nuboli**  411

 **Null vector**   118 350

 **Nur**   306 362

Nur mini  306 362





Nur 1618  362

 **Nur gloss**  308 366



Nur gloss mini  308 366

 **Objective**   104 158 236

 **One line**  114

	Onfale grande		130
	Onfale medio		130
	Onfale piccolo		130

	Pantalica		442	442
--	-----------	---	-----	-----

	Pantarei		269	269
--	----------	---	-----	-----

	Patroclo		424
--	----------	---	-----

	Pausania		428
--	----------	---	-----

	Pipe		438	438	438	438
---	------	--	-----	-----	-----	-----

	Pirce		210	298	330
--	-------	---	-----	-----	-----

	Pirce mini		298	330
--	------------	---	-----	-----

	Pirce micro		210	330
--	-------------	---	-----	-----

	Platea		243
--	--------	---	-----

	Prometeo		434
--	----------	---	-----

	Rea 12		218
--	--------	---	-----



	Rea 17		218
--	--------	---	-----



	Reall		150	226
--	-------	---	-----	-----

	Reeds		188
--	-------	---	-----

	Robbia 30		266
	Robbia 60		266

	Scopas		336
---	--------	---	-----

	Skopos		264
---	--------	---	-----

	Shogun		430
---	--------	---	-----

	Sisifo		72
---	--------	---	----

	Skydro		310
---	--------	---	-----

	Solium		142
--	--------	--	-----

	Space cloud		334
---	-------------	---	-----

	Talak		115	162	248
---	-------	---	-----	-----	-----

	Talo		212
---	------	---	-----

	Talo 90		214	368
--	---------	---	-----	-----

	Talo 120		214	368
--	----------	---	-----	-----

	Talo 150		214	368
--	----------	---	-----	-----

	Talo 180		214	368
--	----------	---	-----	-----

	Talo 240		214	368
--	----------	---	-----	-----

	Tatsuno-Otoshigo		52
---	------------------	---	----



 **Telefo 50**  268

Telefo 70  268

Telefo 120  268

Telefo 170  268

 **Teti**  267 267

 **Tian Xia Metamorfosi**  358

Tian Xia 500 Led   360

 **Tizio**   82 161

Tizio 35  82 161

Tizio micro  82

Tizio Plus  82 161

Tizio X30  82 161

 **Tolomeo**   86 196 252 398 400

Tolomeo mini  86 252

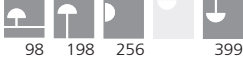

Tolomeo midi  86 252

Tolomeo micro  86 196 252

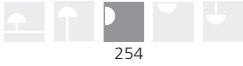

 **Tolomeo basculante**  98 198 256 399



 **Tolomeo faretto**  254

Tolomeo micro faretto  254

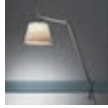
 **Tolomeo pinza**  255



Tolomeo micro pinza  255

 **Tolomeo mega**  99 194 258 402

 **Tolomeo parete diffusore 18**  259

Tolomeo parete diffusore 24  259

Tolomeo parete diffusore 32  259

 **Tolomeo XXL**  200

 **Unterlinden**  326

 **Wuni**  58

 **Yadokari**  42

 **Yang**  186

IN-EI ISSEY MIYAKE

Awards

2014 – Compasso d'Oro / A.D.I.
Milano (Italia)

2013 – Reddot Design Award
Essen (Deutschland)

2013 – iF Product Design Award Gold
Deutschland



42
YADOKARI



43
HOSHIGAME



44
MENDORI



54
HAKOFUGU



55
HAKOFUGU
micro



55
HAKOFUGU
micro stelo



45
MENDORI mini



46
MOGURA



46
MOGURA
mini



48
MINOMUSHI
terra



49
MINOMUSHI
sospensione



50
FUKUROU
terra

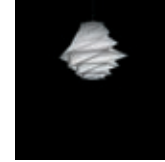

51
FUKUROU
sospensione



52
TATSUNO-
OTOSHIGO



58
WUNI



59
KATATSUMURI



Issey Miyake, ph. Brigitte Lacombe



Ernesto Gismondi, ph. Chris Broadbent

IN-EI ISSEY MIYAKE realizzata da Artemide è una collezione di lampade a sospensione, da tavolo e da terra; le ombre create dalle lampade sono percorse da sottili e bellissime sfumature luminose. Le pieghe inimitabili che determinano le forme plastiche e la solidità delle lampade sono realizzate con una tecnologia originale creata da Issey Miyake.

Grazie al materiale riciclato, dalla trasparenza luminosa superiore a quella della carta, le lampade mantengono perfettamente la loro forma senza richiedere strutture interne: il processo di piegatura, infatti, crea volumi sufficientemente solidi, che possono essere rimodellati senza problemi. Quando non sono utilizzate le lampade possono essere conservate piegate.

“Sono particolarmente orgoglioso di questa collaborazione”, afferma Ernesto Gismondi;

“Issey Miyake dedica il proprio eccezionale impegno artistico a una ricerca attenta alle esigenze dell’uomo e della sua vita: lo stesso impegno si riconosce in The Human Light, la filosofia che guida la missione Artemide. Con Miyake si è trattato quindi innanzitutto di una sintonia di valori e di visione”.

IN-EI” in giapponese significa “ombra, ombreggiatura, sfumatura” e la ricerca è iniziata nel 2010 al Miyake Design Studio quando un nuovo processo fu sviluppato da Jun Mitani usando un programma matematico con formule geometriche tridimensionali.

“132 5. ISSEY MIYAKE” è un metodo geniale per creare abiti e costituisce un esempio di ciò cui può giungere la ricerca sui materiali tessili e sulle tecnologie. Infatti il progetto si avvale di un tessuto speciale capace di assumere e mantenere forme in 3D partendo da un singolo pezzo di tessuto.

IN-EI ISSEY MIYAKE è nato dall’incontro tra la competenza Artemide nel mondo della luce e l’approccio innovativo del Reality Lab, verso i materiali e il design.

1
3
2
4
5

Il pezzo unico di tessuto da cui nasce ogni creazione.
The one-piece fabric used for each product.

La tridimensionalità.
Refers to 3D.

Inizialmente il tessuto è piegato in forma bidimensionale.
Comes from the 2D initial folding process.

Uno spazio vuoto.
An empty space.

La metamorfosi delle forme piegate quando divengono abito o oggetto.
The metamorphosis turning folded shapes into clothing or objects.



Issey Miyake

After studying graphic design at the Tama Art University in Tokyo (1964), Issey Miyake (born in Hiroshima in 1938) moved to Paris (1966-68), where he worked as an apprentice with G. Laroche and H. de Givenchy. In 1971 he set up his own fashion house and

presented the first collection under his name in New York. Since the early seventies, Miyake has been carrying out research into materials and design techniques at his Tokyo studio. Out of this came his rigid plastic bustiers, gowns made of oilcloth and later, in the early nineties, his

celebrated pleated garments. In Paris the Fondation Cartier staged a retrospective of his work entitled *Issey Miyake Making Things* (1999). In his creations traditional Oriental elements are fused with technologies and high-tech materials typical of the West.

Artemide's IN-EI ISSEY MIYAKE is a collection of suspended, table and floor lamps; the shadows cast by the lamps are combined with subtle, beautiful nuances of light. The unique folds creating the shapes and the durability of the shades are the result of an innovative technology developed by Issey Miyake. Thanks to a recycled material featuring a higher transparency to light than paper, the plasticity of the lampshades is perfectly achieved without need for internal structures: the process of folding actually creates volumes which are solid enough to be easily remodelled. When not in use, the lamps can be folded and stored. "I'm particularly proud of this collaboration," says Ernesto Gismondi. "Issey Miyake devotes his exceptional artistic talents to a research focused on the needs and lives of the individuals: the same commitment can be seen in *The Human Light*, Artemide's leading philosophy. So our values and vision were in tune with Issey Miyake from the very beginning." IN-EI it means "shadow, shading, nuance" in Japanese; the project started in 2010 at the Miyake Design Studio when Jun Mitani created a new process using a computer software based on 3D geometric formulae. "132 5. ISSEY MIYAKE" is a clever method of creating clothing and represents an successful example of what can be achieved through thorough research into textiles and technology. The IN-EI project uses a special fabric that can be folded to create and retain three-dimensional shapes. IN-EI ISSEY MIYAKE was created through the partnership between Artemide lighting know-how and Reality Lab' innovative approach to materials and design.

IN-EI ISSEY MIYAKE réalisée par Artemide est une collection de suspensions, lampes de table et lampadaire ; les ombres créées par les lampes sont parcourues par des subtiles et très belles nuances lumineuses. Les plis inimitables qui déterminent les formes plastiques et la solidité des lampes sont réalisés avec une technologie originale créée par Issey Miyake. Grâce au matériel recyclé, d'une transparence lumineuse supérieure à celle du papier, les lampes gardent une forme parfaite sans avoir besoin d'une structure interne : le processus de pliage, en effet, crée des volumes suffisamment solides qui peuvent être modelés sans aucun problème. Quand elles ne sont pas utilisées les lampes peuvent être repliées et ainsi conservées. « Je suis particulièrement fier de cette collaboration », affirme Ernesto Gismondi, « Issey Miyake consacre son exceptionnel engagement artistique à une recherche attentive aux exigences de l'Homme et de sa vie : le même engagement est reconnaissable dans *The Human Light*, la philosophie qui guide la mission d'Artemide. Avec Miyake il a été question donc tout d'abord d'un partage de valeurs et de vision ». IN-EI en japonais signifie « ombre, obscurité, nuance » et la recherche a débuté en 2010 au Miyake Design Studio pendant qu'un nouveau processus a été développé par Jun Mitani en utilisant un programme mathématique avec des formules géométriques tridimensionnelles. « 132 5. ISSEY MIYAKE » est une méthode révolutionnaire pour créer des vêtements et constitue un exemple de ce que l'on arrive à réaliser à travers la recherche sur les textiles et les technologies. Le projet en effet se base sur un tissu spécial capable de structurer et garder des formes en 3D tout en partant d'un seul morceau de tissu. IN-EI ISSEY MIYAKE est né de la rencontre entre les compétences d'Artemide dans le secteur de l'éclairage et l'approche innovatrice du Reality Lab concernant les matériaux et le design.

Die Artemide-Kollektion IN-EI ISSEY MIYAKE besteht aus Pendel-, Tisch- und Stehleuchten. Die von den Leuchten erzeugten Schatten, werden von zarten, wunderschönen Lichtnuancen durchzogen. Die unnachahmlichen Falten, die die plastische Form und Stabilität der Leuchten bestimmen, werden mit einer eigens von Issey Miyake entwickelten Technik hergestellt. Durch das recycelte PET-Material, das eine höhere Lichtdurchlässigkeit als Papier aufweist, behalten die Leuchten auch ohne Innenrahmen exakt ihre Form. Das Falten des Materials führt nämlich zu stabilen Konstruktionen, die problemlos wieder neu geformt werden können. Wenn die Leuchten nicht eingesetzt werden, können sie flach zusammengefaltet aufbewahrt werden. „Ich bin auf diese Zusammenarbeit besonders stolz“, bestätigt Ernesto Gismondi. „Issey Miyake stellt sein außerordentliches künstlerisches Engagement in den Dienst der sorgfältigen Erforschung der Bedürfnisse des Menschen und seines Lebens. Dasselbe Engagement liegt auch der Philosophie *The Human Light* zugrunde, zu der Artemide sich verpflichtet hat. Mit Miyake gab es vor allem in den Werten und der Sichtweise eine große Übereinstimmung.“ Das japanische „IN-EI“ heißt so viel wie „Schatten, Schattenreichtum, Schattierung“; das Forschungsprojekt begann 2010 mit Miyake Design Studio, als Jun Mitani auf der Grundlage eines Mathematikprogramms mit dreidimensionalen geometrischen Formeln ein neues Verfahren entwarf. „132 5. ISSEY MIYAKE“ beschreibt eine geniale Methode zur Herstellung von Kleidungsstücken und ist ein Beispiel dafür, was Forschung bei Textilmaterialien und in der Technologie leisten kann. Und in der Tat bedient sich dieses Projekt einer speziellen Faser, die - ausgehend von einem einzigen Stück Stoff - in der Lage ist, dreidimensionale Formen zu bewahren. IN-EI ISSEY MIYAKE ist aus dem Zusammenspiel der Lichtkompetenz von Artemide und dem innovativen Ansatz von Reality Lab gegenüber Materialien und Design entstanden.

IN-EI ISSEY MIYAKE realizada por Artemide es una colección de lámparas de suspensión, sobremesa y de pie; las sombras creadas por las lámparas se manifiestan a través de manchas sutiles y bellas de la luz. Gracias al material reciclado, desde la transparencia luminosa superior a la del tejido, las lámparas mantiene perfectamente su forma sin necesitar estructuras internas: el proceso de plegado, de hecho, crea volúmenes suficientemente sólidos, que pueden ser remodelados sin problemas. Cuando las lámparas no se utilizan se pueden conservar plegadas. "Estoy particularmente orgulloso de esta colaboración" afirma Ernesto Gismondi; "Issey Miyake dedica su propio tiempo de creación a una búsqueda que se fija en las exigencias del hombre y de su vida; el mismo empeño se reconoce en *The Human Light*, al filosofía que guía la misión Artemide. Con Miyake se ha tratado sobre todo de una sintonía de valores y visión". IN-EI en japonés significa "sombra, sombreado, matices" y la búsqueda empieza en el 2010 en el Estudio Miyake Design cuando un nuevo proceso se desarrolla por Jun Mitani usando un programa matemático con fórmulas geometrías tridimensionales. "132 4. ISSEY MIYAKE" es un método genial para cera ropa y constituye un ejemplo de y constituye un ejemplo de lo que puede lograrse a través de la investigación de los textiles y las tecnologías. De hecho, el proyecto IN -EI hace uso de un tejido especial que se puede plegar para asumir y mantener las formas tridimensionales. IN -EI ISSEY MIYAKE nació del encuentro entre la experiencia de Artemide en el ámbito de la iluminación y el enfoque innovador adoptado por el Laboratorio de Realidad hacia los materiales y el diseño.

YADOKARI

design

Issey Miyake + Reality Lab.
2014

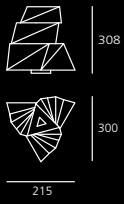

LED max 6W (E14)
Lamp included

IP20 ERAC

Energy Label n°36



HOSHIGAME

design

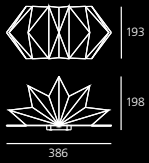
Issey Miyake + Reality Lab.
2012陰翳
IN-EI
ISSEY MIYAKE

LED max 6W (E14)

Lamp included

IP20  EAC

Energy Label n°36



MENDORI
MENDORI mini

design

Issey Miyake + Reality Lab.
2012, 2014

Awards

MENDORI

2013 – Delta Award for Industrial design
Deutschland, Nominierung

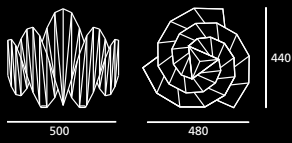

**MENDORI**

LED total power 10W
Color temperature 3000K
Lighting output 425lm

IP20 

+  Dimmer

Energy Label n°1

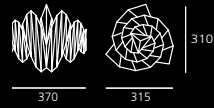
**MENDORI mini**

LED total power 9W
Color temperature 2700K
Lighting output 300lm

IP20 

Energy Label n°1



MOGURA
MOGURA mini

design

Issey Miyake + Reality Lab.
2012

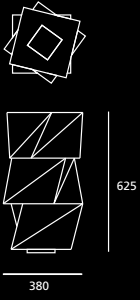

MOGURA

LED total power 10W
Color temperature 3000K
Lighting output 378lm

IP20     Dimmer

Energy Label n°1



MOGURA mini

LED total power 10W
Color temperature 3000K
Lighting output 378lm

IP20     Dimmer

Energy Label n°1



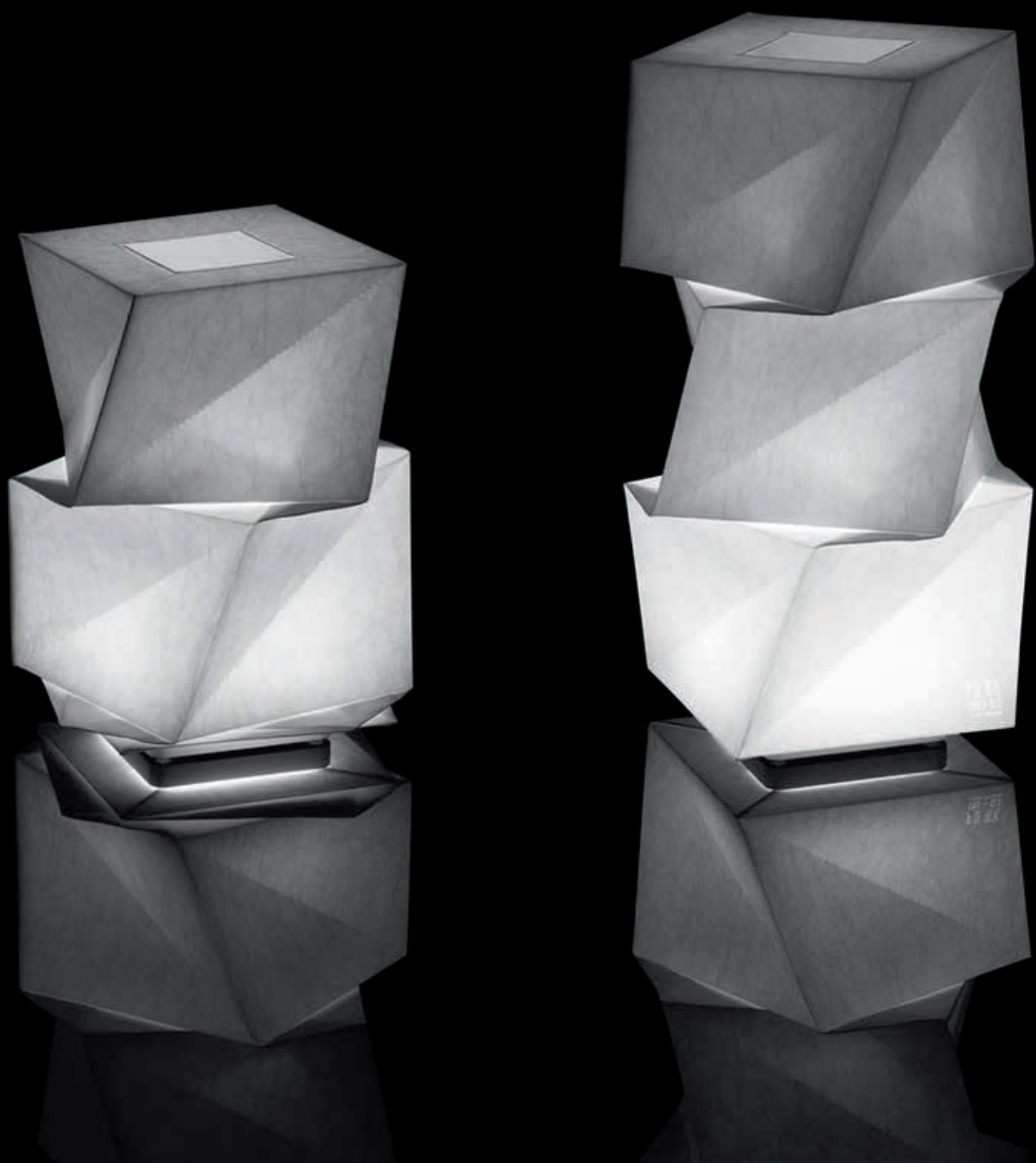

MINOMUSHI
terra

design

Issey Miyake + Reality Lab.
2012

陰翳
IN-EI
ISSEY MIYAKE

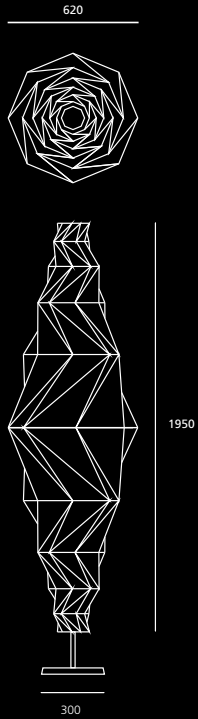

LED total power 28W
Color temperature 3000K
Lighting output 1743lm

IP20   EAC

+  Dimmer

Energy Label n°1



MINOMUSHI
sospensione

design

Issey Miyake + Reality Lab.
2012

陰翳
IN-EI
ISSEY MIYAKE

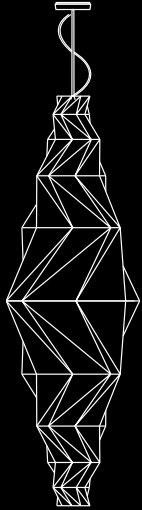

1950

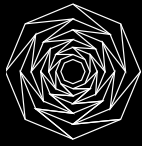

620

LED total power 28W
Color temperature 3000K
Lighting output 1743lm
Dimmable

IP20   EneC

Energy Label n°1



FUKUROU terra

design

Issey Miyake + Reality Lab.
2012

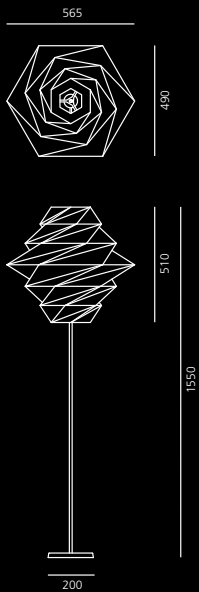

IN-EI

ISSEY MIYAKE

LED max 20W (E27)
Lamp included

IP20  EAC

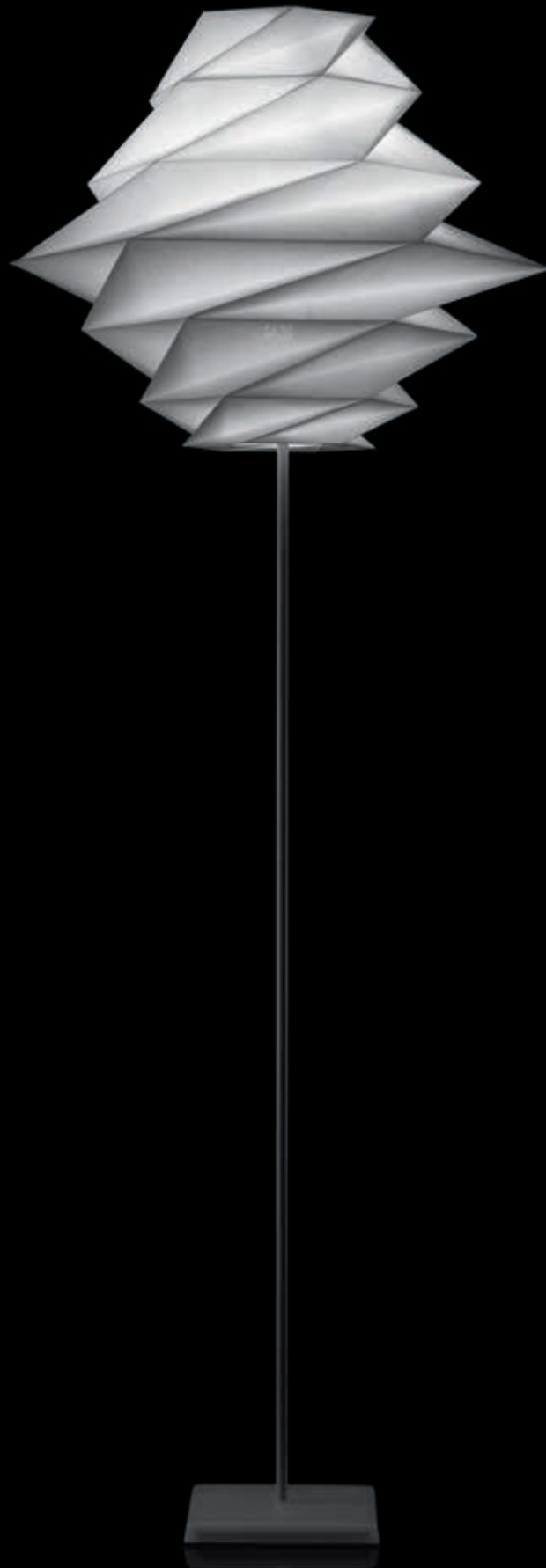
Energy Label n°9



FUKUROU sospensione

design

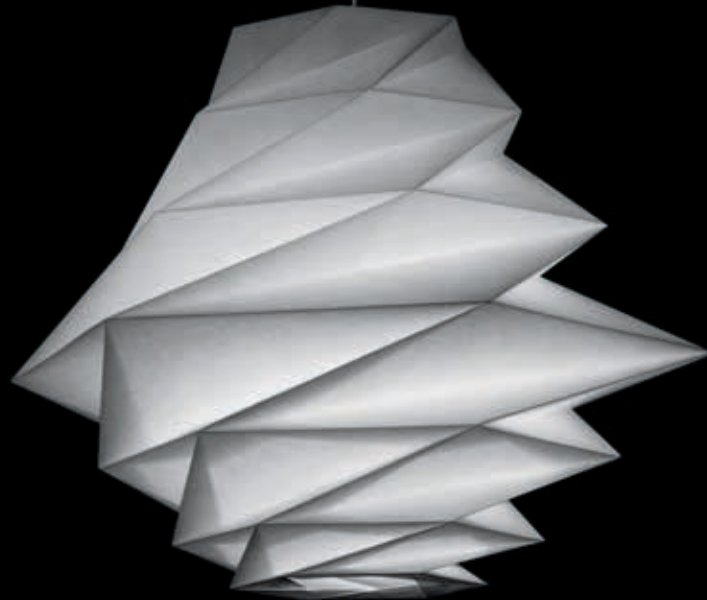
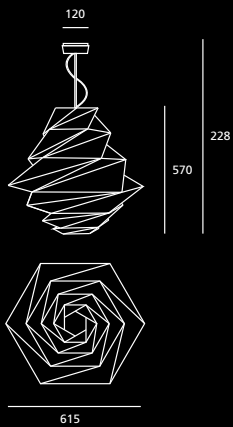
Issey Miyake + Reality Lab.
2012陰翳
IN-EI
ISSEY MIYAKE

LED max 17W (E27)
Lamp included

IP20  EAC

Energy Label n°9

TATSUNO-OTOSHIGO

design

Issey Miyake + Reality Lab.
2012

IN-EI

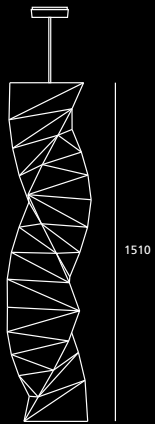
ISSEY MIYAKE

LED total power 28W
Color temperature 3000K
Lighting output 1500lm
Dimmable

IP20  EAC

Energy Label n°1





HAKOFUGU

design

Issey Miyake + Reality Lab.
2012

IN-EI

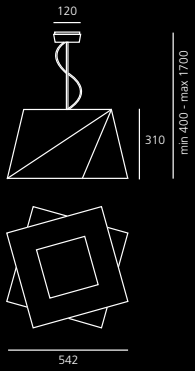
ISSEY MIYAKE

LED max 17W (E27)

Lamp included

IP20   EAC

Energy Label n°9



HAKOFUGU micro
HAKOFUGU micro stelo

design

Issey Miyake + Reality Lab.
2013

陰翳
IN-EI
ISSEY MIYAKE

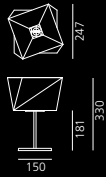
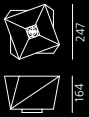

HAKOFUGU micro

LED max 6W (E14)

Lamp included

IP20  EAC

Energy Label n°36

HAKOFUGU micro stelo

LED max 6W (E14)

Lamp included

IP20  EAC

Energy Label n°36

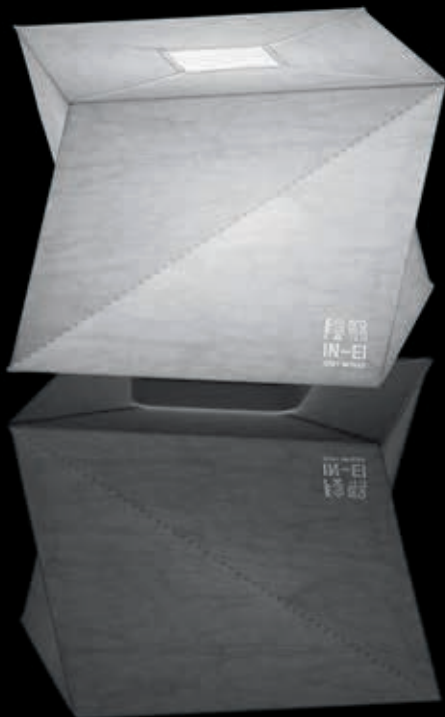





WUNI

design

Issey Miyake + Reality Lab.
2014

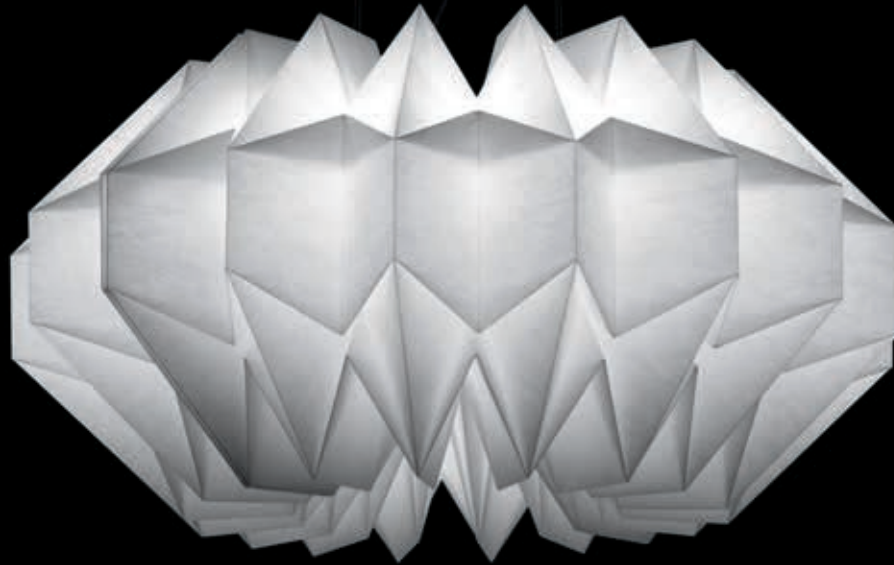
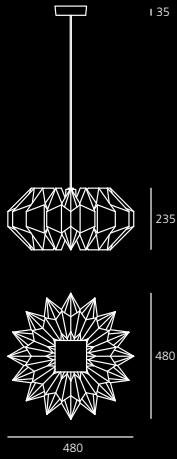
 陰翳
IN-EI
ISSEY MIYAKE

LED max 20W (E27)

Lamp included

IP20  EAC

Energy Label n°36

KATATSUMURI

design

Issey Miyake + Reality Lab.
2012

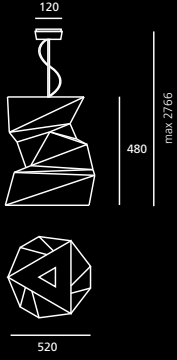
 陰翳
IN-EI
ISSEY MIYAKE

LED max 17W (E27)

Lamp included

IP20  EAC

Energy Label n°9



Lampade da tavolo

Table lamps
Lampes de table
Tischleuchten
Lámparas de sobremesa



62
Empatia



66
Meteorite



66
Meteorite stelo



104
Objective



106
Lotek



108
Ipparco



122
Aqua Cil tavolo



124
Dioscuri tavolo



126
Castore tavolo



70
Laguna



72
Sisifo



76
Demetra



82
Tizio



86
Tolomeo



98
Tolomeo basculante
tavolo



99
Tolomeo mega
tavolo



100
Equilibrist



110
Halo



112
Itis



114
One line



115
Talak tavolo



116
Fiamma tavolo



118
Null vector



120
Melampo tavolo
Melampo notte



121
Choose tavolo



128
Logico tavolo



130
Onfale tavolo



131
Miconos tavolo



132
Dalù



133
Nessino

Empatia 16
Empatia 26
Empatia 36

design

Carlotta de Bevilacqua
Paola di Arianello
2013



Light emission



Colour



White

Awards

2014 - Wallpaper Design Awards
2014 - iF Product Design Award
Deutschland

La famiglia di lampade Empatia, composta dalle versioni tavolo, parete/soffitto, sospensione e terra, nasce dal connubio tra la grande tradizione del vetro soffiato veneziano e la LED technology.

Materiali: corpo in alluminio verniciato; diffusore in vetro soffiato trasparente con finitura seta lucida; guida luce in metacrilato a basso coefficiente di assorbimento; piastra di fissaggio del vetro in alluminio verniciato.

Specificità: la lavorazione artigianale permette di ottenere dei pezzi unici, dove la trasparenza e l'opacità sono sapientemente dosati per ottenere un vetro che riflette e diffonde la luce senza abbagliare e perdere in efficienza. La macchina ottica ha il suo cuore in un light engine LED dalle elevate prestazioni. La luce è controllata con il massimo rendimento e guidata al diffusore in vetro attraverso un light pipe trasparente dal bassissimo coefficiente di assorbimento.



Empatia 16

LED Total power 11W
Color temperature 3000K
Lighting output 530lm



+ Touch Dimmer

Energy Label n°1

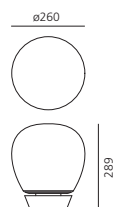

Empatia 26

LED Total power 16W
Color temperature 3000K
Lighting output 710lm



+ Touch Dimmer

Energy Label n°1

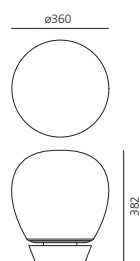

Empatia 36

LED Total power 24W
Color temperature 3000K
Lighting output 1189lm



+ Touch Dimmer

Energy Label n°1



Photo by Elliott Erwit, Milan, November 2014
Photocamera: Canon model EOS 1N
Black and white film: Kodak Professional Tri-X400







Empatia 26

Empatia 16

Empatia 36

The Empatia family is available in table, wall / ceiling, suspension and floor versions, born from the synthesis between a great ancient glass-blowing tradition and state-of-the-art LED technologies.

Materials: heatsink/electronic unit in painted aluminium; diffuser in blown glass with polished-silk finish; light pipe made by low absorption coefficient methacrylate; glass back plate in painted aluminium.

Specifications: the art of craftsmanship creates unique glass pieces, where light is reflected without glaring and loss of efficiency through a well-measured combination of transparency and opaqueness. The optical device includes a high-performance LED-based light engine, which is separated from the glass emission body for higher thermal efficiency and performance.

La famille de lampes Empatia composée des versions lampe de table, applique/plafonnier, suspension et lampadaire naît de la rencontre entre la tradition du verre soufflé vénitien et la technologie LED

Matériaux : dissipateur thermique/unité électronique en aluminium verni ; diffuseur en verre soufflé transparent avec finition en soie brillante ; guide lumière en méthacrylate ayant un coefficient d'absorption réduit ; plaque de fixation du verre en aluminium verni.

Spécificités : le travail artisanal permet d'obtenir des pièces uniques où la transparence et l'opacité sont judicieusement dosées afin d'obtenir un verre qui réfléchit et diffuse la lumière sans éblouissement et sans perte d'efficacité lumineuse. Le dispositif optique a en son cœur un moteur d'éclairage LED haute performance positionné séparément du corps en verre pour une grande efficacité. La lumière est contrôlée avec un rendement maximal et dirigée jusqu'au diffuseur en verre par le biais d'un guide lumière transparent ayant un coefficient d'absorption très bas.

Die Leuchtenfamilie Empatia besteht aus Tisch-, Wand-/Decken-, Pendel-, sowie Bodenleuchten und vereint die große venezianische Tradition der Glasbläserei mit neuester LED-Technologie.

Materialien: Kühlkörper/elektronische Beleuchtungseinheit aus lackiertem Aluminium; Schirm aus transparentem, mundgeblasenem Glas in seidig glänzendem Finish; Lichtstab aus Methacrylat mit niedrigem Absorptionskoeffizienten; Befestigungsplatte für das Glas aus lackiertem Aluminium.

Spezifikation: Die Glasbläserei erzeugt Unikate, in denen Transparenz und Opazität sorgfältig dosiert werden, um ein Glas herzustellen, das Licht ohne Blendwirkung und Strahlungsverlust reflektiert. Das Herzstück bildet eine leistungsstarke LED Beleuchtungseinheit, die zugunsten des Wärmewirkungsgrads und der Leistung vom gläsernen Emissionskörper getrennt ist. Das Licht wird mit maximaler Ausbeute durch einen transparenten Lichtstab mit äußerst geringem Absorptionskoeffizienten zum Glasschirm gelenkt.

La familia de lámparas Empatia formada por las versiones de sobremesa, pared/techo, suspensión y pie, nace de la asociación entre la gran tradición del soplado del cristal y la tecnología LED.

Materiales: dissipador/núcleo electrónico en aluminio pintado; difusor en cristal soplado transparente con acabado seda lúcido; guía de luz en metacrilato de bajo coeficiente de absorción; plancha de fijación del cristal en aluminio pintado.

Especificaciones: la elaboración artesanal permite obtener piezas únicas; donde la transparencia y la opacidad son sabiamente dosificadas para obtener un vidrio que refleja la luz sin deslumbrar y sin perder eficiencia. La unidad óptica tiene como núcleo un motor de luz LED de alto rendimiento. La luz controlada con el máximo rendimiento y conducida hacia el difusor de cristal a través de un tubo transparente con un coeficiente de absorción muy bajo.

Meteorite 15/35
Meteorite 15/35 stelo

design
Pio & Tito Toso
2014



Light emission



Colour



White

Famiglia di lampade che si articola in cinque tipologie: tavolo, tavolo con stelo, terra, parete/soffitto e sospensione.

Materiali: diffusore in vetro soffiato; corpo della lampada in polimero tecnico e acciaio. La versione Meteorite 15 Stelo Tavolo ha lo stelo in alluminio cromato, mentre la versione 35 ha lo stelo in acciaio.

Specificità: il diffusore è realizzato in vetro artistico a doppio strato, ottenuto con la tecnica artigianale della soffiatura in stampo a fermo e la conseguente molatura.

Awards

2015 - Reddot Design Award
Essen (Deutschland)

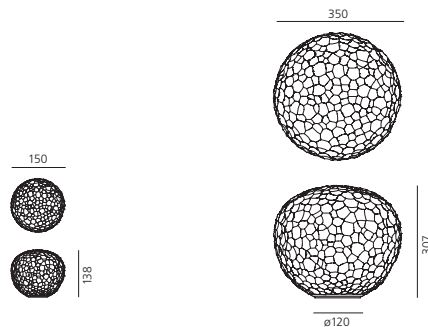

Meteorite 15

HALO max 1X48W (G9)
Lamp included



Energy Label n°18

Meteorite 35

HALO max 150W (E27)



+ Dimmer

Energy Label n°4





Meteorite 15

Meteorite 35

A family of lamps available in five different versions: table, table with stem, floor, wall/ceiling and suspension.

Materials: blown glass diffuser; lamp body in technopolymer. Meteorite Stem Table 15 and 35 feature respectively a chromed aluminium and a steel stem.

Specification: the diffuser is made of a double layer of artistic glass, obtained through a 'stampo a fermo' mould-blowing technique and then grinding.

Il s'agit d'une famille de lampes qui s'articule en cinq typologies : lampe à poser, lampe de table, lampadaire, applique/plafonnier et suspension.

Matériaux : diffuseur en verre soufflé ; corps en techno-polymère et acier. La version lampe de table Meteorite 15 prévoit une tige en aluminium chromé tandis que la version 35 prévoit une tige en acier.

Spécificités : le diffuseur est réalisé en verre artistique avec une double couche, obtenu avec la technique artisanale du soufflage dans un moule fermé et traité avec un abrasif.

Die Leuchtenfamilie besteht aus Tischleuchten mit oder ohne Stab, Boden-, Wand- / Decken-, und Pendelleuchten

Materialien: Schirm aus mundgeblasenem Glas; Leuchtenkörper aus Technopolymer und Stahl. Die Tischleuchte Meteorite 15 besitzt einen verchromten Aluminiumstab während der Stab der Meteorite 35 aus Stahl gefertigt ist.

Spezifikation: Der Schirm besteht aus doppelschichtigem Kunstglas, hergestellt in einem speziell entwickelten handwerklichen Fertigungsprozess aus Mundbläserei und Schleiftechnik.

Una familia de lámparas compuesta por 5 tipologías: sobremesa, sobremesa con tija, pie, pared/techo y suspensión.

Materiales: difusor en cristal soplado; cuerpo de la lámpara en polímero y acero. La versión Meteorite 15 stelo tavolo tiene la tija en aluminio cromado, mientras la versión 35 tiene la tija en acero.

Especificaciones: el difusor está hecho de una doble capa de vidrio artístico, que se obtiene con la técnica artesanal de soplado y moldeado.

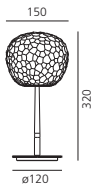

Meteorite 15 stelo
HALO max 1X48W (G9)
Lamp included



Energy Label n°18

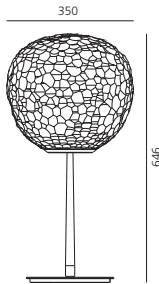

Meteorite 35 stelo
HALO max 150W (E27)



+ (D) - Dimmer

Energy Label n°4





Meteorite 35 stelo

Meteorite 15 stelo

Laguna 16
Laguna 26
Laguna 37

design

Matteo Thun
Antonio Rodriguez
2013



Light emission



Colour



Black brown

Una ricca collezione di lampade in vetro, che si articola in tre dimensioni e nella versione tavolo, terra, soffitto e sospensione.

Materiali: corpo della lampada in alluminio estruso verniciato nero (black brown); diffusore in vetro soffiato.

Specificità: il vetro soffiato lattimo con sfumatura cristallo permette di ottenere una luce morbida localizzata sul piano o sulla parete e una luce più performante verso l'ambiente.



Laguna 16

LED Total power 13W
Color temperature 3000K
Lighting output 539lm



Microswitch dimmer

Energy Label n°1

A wide collection of glass lighting appliances available in three sizes. Each size is available in the table, floor, ceiling and suspension version.

Materials: black painted lamp body in extruded aluminum; diffuser in blown glass.

Specification: the milky-white, blown glass with crystal nuances produces a soft spot light on the table top or wall, plus a high-performing light towards the surrounding environment.

Une riche collection de lampes en verre qui s'articule en trois dimensions en version lampe de table, lampadaire, plafonnier et suspension.

Matériaux : corps en aluminium extrudé verni noir (noir brun), diffuseur en verre soufflé.

Spécificités : le verre soufflé laiteux avec une nuance cristalline permet d'obtenir une lumière douce et localisée sur le plan ou sur le mur ainsi qu'une lumière plus performante vers l'espace.

Eine umfangreiche Kollektion aus Glasleuchten, die in jeweils drei Größen als Tisch-, Steh-, Decken- und Pendelleuchten erhältlich sind.

Materialien: Der Leuchtenkörper, besteht aus fließgepresstem Aluminium schwarz-braun; Schirm aus mundgeblasenem Glas.

Spezifikation: Das mundgeblasene Opalglas mit kristallinen Nuancen gibt einen weichen Spot nach oben ab und streut gleichzeitig leistungsstarkes Licht in die Umgebung.

Una amplia colección de lámparas en cristal disponibles en tres tamaños y en las versiones de mesa, pie, techo y suspensión.

Materiales: cuerpo de la lámpara en aluminio extruido pintado negro (black Brown); difusor en cristal soplado.

Especificaciones: el cristal soplado de color blanco lechoso permite obtener una luz morbida localizada sobre el suelo o en la pared y una luz de alto rendimiento en todo el entorno.

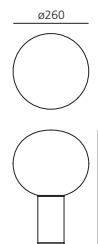

Laguna 26

LED Total power 24W
Color temperature 3000K
Lighting output 1211lm



Microswitch dimmer

Energy Label n°1

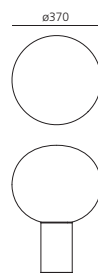

Laguna 37

LED Total power 31W
Color temperature 3000K
Lighting output 1881lm



Microswitch dimmer

Energy Label n°1



Laguna 26

Laguna 37

Laguna 16



Sisifo

design

Scott Wilson
2013Innovation Patent Pending
n. MI2012A001399

Light emission



Colour



White

Awards2015 – iF Product Design Award
Deutschland

Lampada da tavolo che bilancia comfort visivo ed esigenze di illuminazione dell'ambiente.

Materiali: la testa e la base cilindrica sono in alluminio estruso, lo stelo orientabile è in ottone cromato e il diffusore in PMMA.

Specificità: lo snodo sferico centrale permette di orientare la luce con la massima libertà e il minimo ingombro della base, garantendo un corretto illuminamento sia su piani di lavoro estesi che su superfici più ridotte. Il diffusore piatto orientabile si inclina in tutte le direzioni ed emette luce LED calda e rilassante.

Light control system: il tocco breve accende/spegne la sorgente LED. Il tocco prolungato è un dimming della sorgente LED.

Al rilascio del tocco prolungato viene invertito il senso di regolazione.

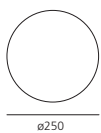
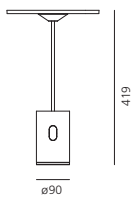

LED Total power 14W
Color temperature 3000K
Lighting output 646lm

IP20 ERL

Touch Dimmer

Energy Label n°1







Table lamp combining the needs for visual comfort and ambient lighting.

Materials: head and cylindrical base in extruded aluminum, adjustable stem in chrome-plated brass, diffuser in PMMA.

Specification: the spherical central joint guarantees maximum freedom in adjusting the light with minimum restrictions due to the small size of the base, allowing its use on both larger tables and small-sized surfaces. The iconic flat diffuser can be tilted in all directions, providing warm relaxing light for any environment.

Light control system: tapping the touch dimmer: LED source will turn on/off; Pressing the touch dimmer: LED source will dim up/down. The dimming is reversed when releasing the pressure from the touch dimmer.

Lampe de table qui équilibre le confort visuel et les exigences d'éclairage de l'espace.

Matériaux : tête et base cylindrique en aluminium extrudé, tige orientable en laiton chromé et diffuseur en PMMA

Spécificités : l'articulation sphérique centrale permet d'orienter la lumière avec une liberté maximale et un encombrement minime de la base garantissant ainsi un éclairage performant aussi bien sur les plans de travail étendus que sur les surfaces réduites. Le diffuseur plat orientable s'incline dans toutes les directions et dégage une lumière LED chaude et relaxante.

Light control system : le contact rapide allume et éteint la source LED. Le contact prolongé permet la variation de la source LED. En relâchant le contact prolongé, on inverse le sens du réglage.

Eine neue Tischleuchte, die als Arbeitsplatz- und Ambiente-Beleuchtung gleichermaßen funktioniert.

Materialien: Runder Leuchtenkopf aus Aluminium und Acrylglas; ausrichtbarer Stab aus verchromtem Messing; zylindrischer Sockel aus Aluminium und Zamak.

Spezifikation: Mit ihrem zentralen Kugelgelenk gewährleistet Sisifo eine maximale Ausrichtung des Lichts bei minimalem Platzbedarf und ist somit ideal für Tische oder kleinere Nachtschränke geeignet. Der flache Leuchtenkopf mit LEDs, scheint zu schweben, lässt sich mühelos in jede gewünschte Position bringen und streut angenehm warmes Licht in den Raum.

Lichtsteuerung: Eine kurze Berührung schaltet die LED-Quelle ein oder aus. Ein längeres Berühren dimmt die LED-Quelle hoch. Bei weiterer Berührung wird die Regulierung umgekehrt, d.h. die LED-Quelle wird runter gedimmt.

Lámparas de sobremesa que equilibra verdaderamente las necesidades de trabajo y de iluminación de ambiente.

Materiales: la cabeza y la base cilíndrica están hechas de aluminio extruido, la tija orientable es de latón cromado ajustable y el difusor de PMMA.

Especificaciones: la articulación central esférica permite orientar la luz con la misma libertad y el mínimo estorbo de la base, garantizando una correcta iluminación sea en el plano de trabajo mismo que sobre superficies más pequeñas. El difusor plano orientable se inclina en todas las direcciones y emite luz LED cálida y relajante.

Sistema Light control: toque corto enciende/apaga la bombilla LED. Toque prolongado es un dimmer de la bombilla LED. Cuando relajamos el toque prolongado se invierte el sentido de la regulación

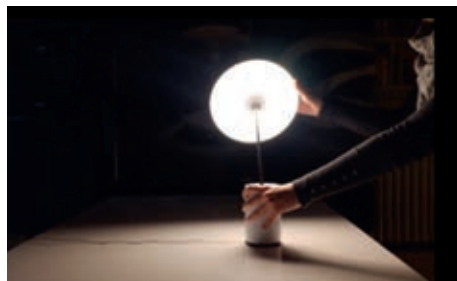

Demetra

design

Naoto Fukasawa
2012

Light emission



Colour

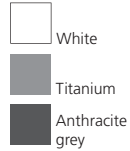

Serie di lampade da tavolo (con gli accessori morsetto e perno fisso), lettura, parete e faretto.

Materiali: base in materiale plastico verniciato, testa e bracci in alluminio verniciato.

Specificità: braccia e diffusore completamente regolabili, girevoli e inclinabili e con una luce LED montata all'interno della testa.

Demetra MD: in questa versione è presente un sensore Movement Detector, che gestisce l'accensione dell'apparecchio a seconda della vicinanza dell'utente.

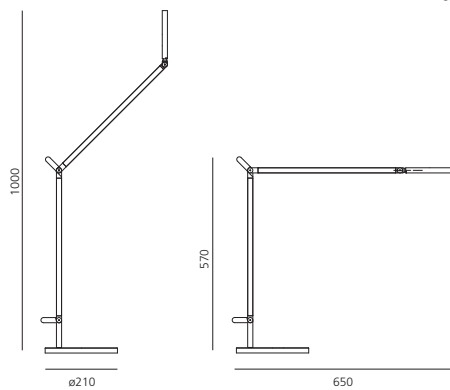
**Demetra**

LED Total power 9,5W
Color temperature 3000K
Lighting output 392lm

IP20

+ - Microswitch dimmer

Energy Label n°1

Demetra MD

LED Total power 9,5W
Color temperature 3000K
Lighting output 392lm

IP20

+ - Microswitch dimmer

Energy Label n°1







White

Titanium



Anthracite grey





Rotation 360°



Dimmer on top



Movement detector

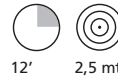

12' 2,5 mt

MD Movement detector

Awards

2014 – Reddot Design Award Essen (Deutschland)
 2014 – iF Product Design Award Deutschland
 2014 – Design Plus, Light+Building Frankfurt am Main (Deutschland)

A selection of table lamps (with table base, clamp and fixed support), also available in the reading, wall and spot versions.

Materials: head and arms in painted aluminium.

Specification: fully adjustable, turnable and tilting arms and diffuser, plus the LED sources integrated into its head.

Demetra MD: this table model features a Motion Detector option detecting moving objects and people and turning the light on or off accordingly.

Il s'agit d'une série de lampes de table comprenant différents accessoires : étau ou pivot, d'une liseuse, d'une applique et spot.

Matériaux : base en matériau plastique verni, tête et bras en aluminium verni.

Spécificités : les bras et le diffuseur sont réglables, orientables et inclinables et intégrant une source LED.

Demetra MD : cette version est dotée d'un détecteur de mouvement qui gère l'allumage de l'appareil selon la présence ou non de l'utilisateur.

Leuchtenfamilie bestehend aus Tischleuchten (mit Tischklemme oder Schraubbefestigung als Zubehör), Leseleuchte, Wandleuchte und Wandstrahler.

Materialien: Lackierter Kunststoffsockel, Leuchtenkopf und Arme aus lackiertem Aluminium.

Spezifikation: Leuchtenarme und Schirm lassen sich in alle Richtungen ausrichten und sind dreh- und kippbar. Der Leuchtenkopf beherbergt LED.

Demetra MD: Diese Version der Tischleuchte ist mit einem Bewegungsmelder ausgestattet.

Serie de lámparas de sobremesa (con los accesorios mordaza y perno fijo), lectura, pared y faretto.

Materiales: ase en material plástico pintado, cabeza y brazos en aluminio pintado.

Especificaciones: brazos y cabezal completamente regulables, giratorios e inclinables y con una luz LED instalada en el interior del cabezal.

Demetra MD: en esta versión existe un sensor de Detección de Movimiento: que gestiona el encendido del aparato según la proximidad del individuo.

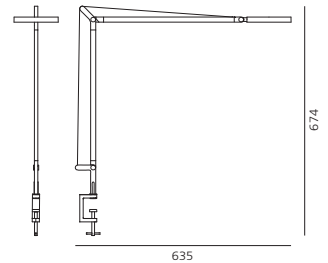

Clamp support

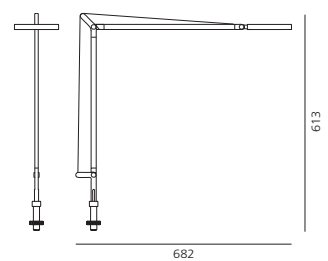

Desk fixed support

Tizio

design

Richard Sapper
1972 - 2008**Awards****Tizio**

1979 – Compasso D'Oro / A.D.I.
Segnalazione - Milano (Italia)
1973 – Casamica – Per l'accessorio
Milano (Italia)
1981 – BIO 9 – Gold Medal
Ljubljana (Slovenia)
1980 – Haus Industrieform
Design Zentrum Nordrhein Westfalen
Essen (Deutschland)

Museum**Tizio**

Twentieth Century Design Collection
of the Metropolitan Museum of Art
New York (USA)
Design Collection of the Museum
of Modern Art – New York (USA)
Itinerario Storico Permanente
Museo Nazionale della Scienza
e della Tecnica Leonardo da Vinci
Milano (Italia)
Sezione Design
Civica Galleria d'Arte Moderna
Gallarate (Italia)
Collection "Design since 1945"
Philadelphia Museum of Art
Philadelphia (USA)
Museum Rufino Tamayo
Mexico City (Mexico)
Victoria and Albert Museum
London (United Kingdom)
The Denver Art Museum
Denver Colorado (USA)
The Israel Museum
Jerusalem (Israel)
Musée des Arts Décoratifs
de Montréal
Montréal (Canada)
Museo Permanente del Design Italiano
1945-1990 – Triennale di Milano
Milano (Italia)
Brooklyn Museum of Art
New York (USA)

Serie di lampade disponibili in diverse dimensioni, con diverse finiture.

Materiali: policarbonato verniciato; versione Tizio bianca in metallo verniciato; testa Tizio LED in alluminio verniciato.

Specificità: testa e bracci orientabili bilanciati da contrappesi.

Nella versione Plus la testa è orientabile anche in senso trasversale.

Tizio X30: in edizione limitata annuale e firmata da Richard Sapper, è prodotta in serie numerata, con base e testina in alluminio lucidato e astine in alluminio brillante anodizzato.





“1972: first halogen source. 2008: Tizio LED”

Range of lamps available in several dimensions, with different finishings.

Materials: painted polycarbonate; Tizio white in painted metal. Tizio LED: head in aluminium.

Specification: adjustable counterbalanced arms and head. Plus version with tilting head.

Tizio X30: is produced in numbered edition, with base and head in polished aluminium and rods in shiny anodised aluminium.

Série de lampes disponibles en différentes dimensions, et en différentes couleurs.

Matériaux : polycarbonate peint ; Tizio blanc en métal verni. Tizio LED: tête en aluminium.

Spécificité : bras articulés et tête orientable, l'ensemble est équilibré par contrepoids. Dans la version Plus, la tête est orientable dans le sens transversal.

La **Tizio X30** est produite en série numérotée, avec base et tête en aluminium poli et bras en aluminium anodisé brillant.

Leuchtenfamilie, erhältlich in verschiedenen Größen und Bestückungen und mit verschiedenen Oberflächen.

Materialien: Lackiertes Polycarbonat; weiße Ausführung aus lackiertem Metall. Tizio LED: Kopf aus Aluminium.

Spezifikation: Ausrichtbare Arme und Leuchtenkopf mit Gegengewichten. Ausführung mit neigbarem Leuchtenkopf.

Tizio X30: In nummerierter Edition, mit Sockel aus druckgegossenem, hochglanzpoliertem Aluminium; Stangen aus eloxiertem Aluminium.

Serie de lámparas disponibles en distintas dimensiones, con diferentes acabados.

Materiales: policarbonato pintado; Tizio blanca de metal pintado. Tizio LED: cabeza en aluminio.

Especificaciones: brazos y cabezal orientables, compensados mediante contrapesos. En el modelo Plus con cabezal, orientable incluso en sentido transversal.

Tizio X30: en serie anual limitada y firmada por Richard Sapper, está producida en serie numerada, con pie y cabezal de aluminio presofuso brillante y varillas de aluminio brillante anodizado.



Tizio 35

Tizio X30

Tizio Plus

Tizio

Tizio Micro

Tizio LED

Light emission

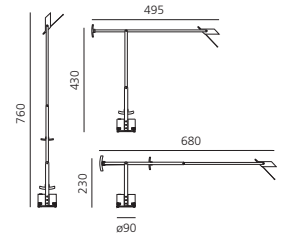
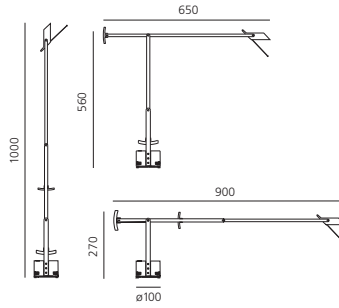
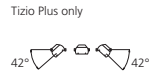
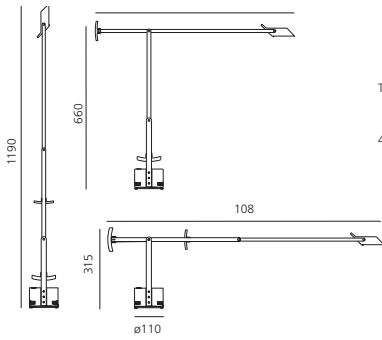

Tizio LED

LED Total power 8W
 Color temperature 3000K
 Lighting output 400lm



+ Microswitch dimmer

Energy Label n°1

Tizio, Tizio X30

HALO max 1x50W/12V (GY6,35) – QT12
 Lamp included
 With two light levels (only Tizio)



Energy Label n°31

Tizio plus

HALO max 1x50W/12V (GY 6,35) - QT 12
 Lamp included



Energy Label n°31

Tizio 35

HALO max 1x35W/12V (GY6,35) – QT12
 Lamp included
 With two light levels



Energy Label n°31

Tizio micro

HALO max 1x20W/12V (G4) – QT9
 Lamp included



Energy Label n°31

Tizio

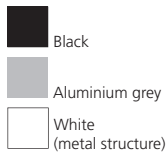

Tizio 35

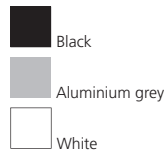

Tizio micro

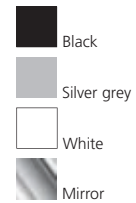

Tizio Plus, Tizio LED



Tizio X30

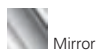

Tolomeo

design

Michele De Lucchi
Giancarlo Piretti

1987, 1991, 2005, 2006, 2013

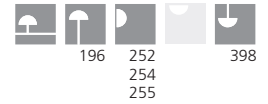
Patent Pending
n. 11161968.0

Awards

1989 – Compasso d'Oro / A.D.I.
Milano (Italia)1987 – SNAI Oscar
des Architectes d'Intérieur
Paris (France)1987 – Haus Industrieform
Deutschland

Tolomeo fluo

2008 – Designpreis der Bundesrepublik
Deutschland, Nominierung

Tolomeo micro

2001 – Observateur du design
Produit sélectionné – A.P.C.I.
Paris (France)

Museum

Itinerario Storico Permanente
Museo Nazionale della Scienza
e della Tecnica Leonardo da Vinci
Milano (Italia)Sezione Design
Civica Galleria d'Arte Moderna
Gallarate (Italia)

The Israel Museum – Jerusalem (Israel)

Musée des Arts Décoratifs
de Montréal Montréal (Canada)Museo Permanente del Design Italiano
1945/1990 – Triennale di Milano
Milano (Italia)

Galleria d'Arte Moderna – Roma (Italia)

Serie di lampade da tavolo, terra, parete e sospensione disponibili
in diverse dimensioni, con diverse sorgenti e finiture.**Materiali:** alluminio.**Tolomeo tavolo:** supporto intercambiabile: base, morsetto, perno fisso
o doppio che permette di montare due corpi lampada indipendenti.
Sistema di equilibratura a molle.Range of table, floor, wall
and suspension lamps
available in several dimen-
sions, with different light
sources and finishings.Série de lampes de table,
lampadaires, appliques
et suspensions disponibles
en différentes couleurs
et dimensions.Leuchtenfamilie bestehend
aus Tischleuchten,
Stehleuchten Wandleuchten
und Pendelleuchten.
Erhältlich in verschiedenen
Größen, unterschiedlichen
Bestückungen und Ober-
flächen.Serie de lámparas de mesa,
de pie, apliques y suspen-
sión; disponibles en distintas
dimensiones, con diferentes
fuentes de luz y acabados.**Materials:** aluminium.**Matériaux :** aluminium.**Materialien:** Aluminium.**Materiales:** aluminio.**Tolomeo tavolo:** inter-
changeable support: table
base, clamp, desk fixed
support and twin support
that allows two independent
lamp units
to be fitted. System
of spring balancing.**Tolomeo tavolo :** le corps
de la lampe peut être associé
à une base, à un étau,
à un pivot ou à un support
qui permet de fixer deux
corps de lampe indépen-
dants. Système d'équilibrage
à ressorts.**Tolomeo tavolo:** Auswech-
selbare Befestigungen:
Tischfuß, Klemme, Schraub-
befestigung oder fest
installierte Montageplatte
zur Befestigung von zwei
Leuchtenkörpern.
Mit Federausgleichsystem.**Tolomeo tavolo:** soporte
intercambiabile: base de
sobremesa, mordaza, perno
fijo para escritorio o Twin
soporte, que permite montar
dos cuerpos de lámpara
independientes. Sistema de
equilibrado a muelles.

Halo

Fluo

LED

LED **TW**
(tunable white)

Metal halide

Tolomeo



Tolomeo mini



Tolomeo midi



Tolomeo micro



Tolomeo XXL







Tolomeo

Tolomeo micro



Tolomeo midi

Tolomeo



Tolomeo micro

Light emission

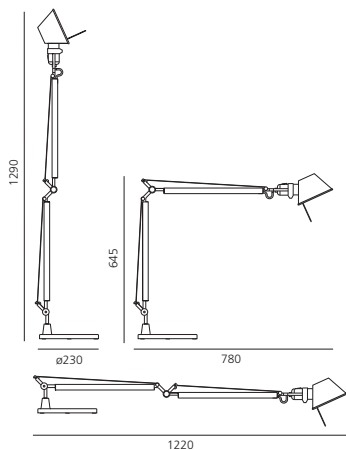

Tolomeo LED/LED MD

LED Total power 10W
Color temperature 3000K
Lighting output 410lm



+ Microswitch dimmer

Energy Label n°1

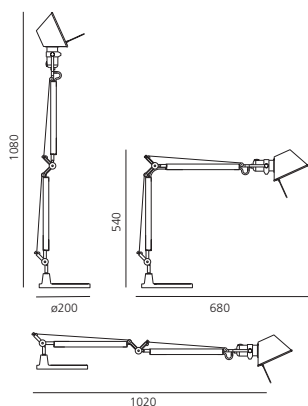

Tolomeo mini LED/LED MD

LED Total power 10W
Color temperature 3000K
Lighting output 410lm



+ Microswitch dimmer

Energy Label n°1

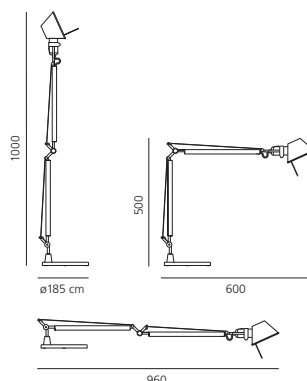

Tolomeo midi LED

LED Total power 9W
Color temperature 3000K
Lighting output 350lm



+ Microswitch dimmer

Energy Label n°1

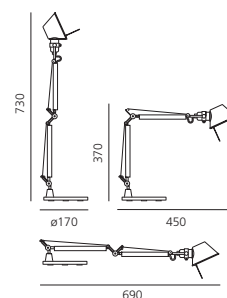

Tolomeo micro LED

LED Total power 8W
(3 Direct LED + 1 Indirect LED)
Color temperature 3000K
Lighting output 350lm



+ Microswitch dimmer

Energy Label n°1

Tolomeo LED TW

LED Total power 12W
Warm/Cold white 3000K/10000K
Lighting output 550lm



+ Microswitch dimmer

Energy Label n°1

Tolomeo mini LED TW

LED Total power 12W
Warm/Cold white 3000K/10000K
Lighting output 550lm



+ Microswitch dimmer

Energy Label n°1

Tolomeo Fluo

FLUO 1x18W (G24q-2) – TC-DEL
Lamp included
Darklight louvre included
With electronic ballast



Energy Label n°35

Tolomeo mini Fluo

FLUO 1x18W (G24q-2) – TC-DEL
Lamp included
Darklight louvre included
With electronic ballast



Energy Label n°35

Tolomeo Halo

HALO max 1x77W (E27)
Lamp included



Energy Label n°29

Tolomeo mini Halo

HALO max 1x77W (E27)
Lamp included



Energy Label n°29

Tolomeo micro Halo

HALO max 1x46W (E14)



Energy Label n°30

Tolomeo Halo

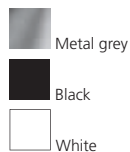

Tolomeo Fluo



Tolomeo LED, LED MD, LED

TW



Tolomeo mini

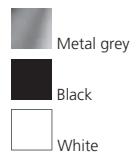

Tolomeo mini Fluo

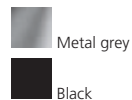

Tolomeo mini LED, LED MD, LED TW



Tolomeo midi LED



Tolomeo micro Halo



Tolomeo micro LED



Desk fixed support



Clamp



Table base





LED technology

Utilizzando la tecnologia LED l'attenzione va posta non solo al consumo di energia e all'efficienza luminosa, ma soprattutto alla qualità e quantità della distribuzione della luce. Infatti il vantaggio del LED è che emette il 100% di flusso luminoso nell'emisfero diretto, annullando dispersioni e sprechi in altre direzioni. Questo significa che per ottenere sul piano di lavoro un illuminamento di 1250lux, con una sorgente incandescente è necessaria una potenza di 100W, mentre con una sorgente LED sono sufficienti 10W, con un risparmio del 90% di energia elettrica.

Using LED technology, attention should be given not only to energy consumption and light efficiency, but above all to the quality and quantity of the light distribution. The main advantage of using LED is that a 100% light flow is diffused into the direct hemisphere, eliminating dispersion and waste in other directions. This means that in order to obtain a 1250 lux illuminance on the work plane a 100W incandescent light source is equivalent to 10W LED source, achieving a 90% energy saving.

En utilisant la technologie LED, on prête attention non seulement à la consommation d'énergie et à l'efficacité lumineuse, mais aussi et surtout à la qualité et la quantité de la distribution de la lumière. En effet, l'avantage de la LED est qu'elle émet 100% du flux lumineux d'hémisphère direct, en annulant ainsi les dispersions et pertes dans les autres directions. Cela signifie que, pour obtenir sur le plan de travail, un éclairage de 1250 lux, avec une source à incandescence, il est nécessaire d'avoir une puissance de 100W, tandis que 10W suffisent avec une source LED, soit 90% d'économie d'énergie électrique.

LED zeichnen sich durch einen stark reduzierten Energieverbrauch, eine lange Lebensdauer und eine optimale Lichtausbeute aus. Bei LED-Leuchten wird das Licht zu 100% direkt in die Umgebung abgegeben, sodass Energievergeudung und Lichtemission in andere Richtungen ausgeschlossen werden können. So ist beispielsweise zur Ausleuchtung einer Arbeitsfläche mit 1.250 Lux bei Einsatz einer Glühlampe eine Leistung von 100W erforderlich, wo hingegen eine LED-Leuchte lediglich 10W benötigt. Hierdurch wird eine Energieeinsparung von 90% erzielt.

Utilizando la tecnología LED la atención se centra no sólo en el consumo de energía y en la eficiencia luminosa, sino sobre todo en la calidad y cantidad de la distribución de la luz. En efecto la ventaja del LED es que emite el 100% de flujo luminoso en el hemisferio directo, anulando dispersiones y despilfarros en otras direcciones. Esto significa que para obtener en el plano de trabajo una iluminación de 1250lux, con una fuente incandescente se necesita una potencia de 100W, mientras con una fuente LED bastan 10W, con un ahorro del 90% de la energía eléctrica.

Horizontal illuminance h 40cm

illuminance med.

illuminance min.

illuminance max.

Tolomeo LED

10W

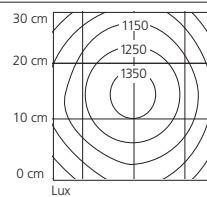

1107 lux

716 lux

1452 lux

Tolomeo FLUO

18W

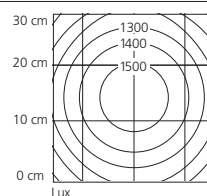

1238 lux

862 lux

1558 lux

Tolomeo HALO

77W

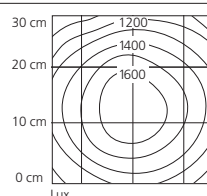

1329 lux

947 lux

1684 lux

Tunable White

Tolomeo Tunable White coniuga i vantaggi della tecnologia LED e quelli della tecnologia Tunable White, consentendo di ottenere numerose declinazioni della luce bianca, nelle sue diverse intensità e varietà di temperature di colore, con un'escursione da 3.200K (luce calda) a 10.000K (luce fredda).

Tolomeo Tunable White combines the advantages of LED technology with those of Tunable White technology, enabling numerous variations of white light to be obtained, with different intensities and varieties of colour temperature, with a range from 3,200K (warm light) to 10,000K (cold light).

Tolomeo Tunable White allie les avantages de la technologie LED à ceux de la technologie Tunable White, ce qui permet d'obtenir de nombreuses déclinaisons de lumière blanche, dans les différentes intensités et variétés de températures de couleur, avec une amplitude allant de 3.200K (lumière chaude) à 10.000K (lumière froide).

Tolomeo Tunable White verbindet die Vorteile der LED-Technologie mit denen des "Tunable White"-Systems, das eine ausgesprochen breite Palette an Weißlicht in verschiedenen Lichtstärken und Farbtemperaturen ermöglicht; die Farbtemperatur beträgt 3.200K bei Warmlicht bzw. 10.000K bei Kaltlicht.

Tolomeo Tunable White conjuga las ventajas de la tecnología LED con las de la tecnología Tunable White, y permite obtener numerosas gamas de luz blanca, en sus diversas intensidades y variedades de temperatura de color, con una variación de 3.200K (luz cálida) a 10.000K (luz fría).





Cold light



Tolomeo mini LED **TW**

Tolomeo LED **TW**

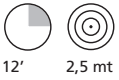

12' 2,5 mt

Tolomeo MD: in questa versione è presente un sensore Movement Detector, che gestisce l'accensione dell'apparecchio a seconda della vicinanza dell'utente.

Tolomeo MD: this table model features a Motion Detector option detecting moving objects and people and turning the light on or off accordingly.

Tolomeo MD : cette version est dotée d'un détecteur de mouvement qui gère l'allumage de l'appareil selon la présence ou non de l'utilisateur.

Tolomeo MD: Diese Version der Tischleuchte ist mit einem Bewegungsmelder ausgestattet.

Tolomeo MD: en esta versión existe un sensor de Detección de Movimiento: que gestiona el encendido del aparato según la proximidad del individuo.

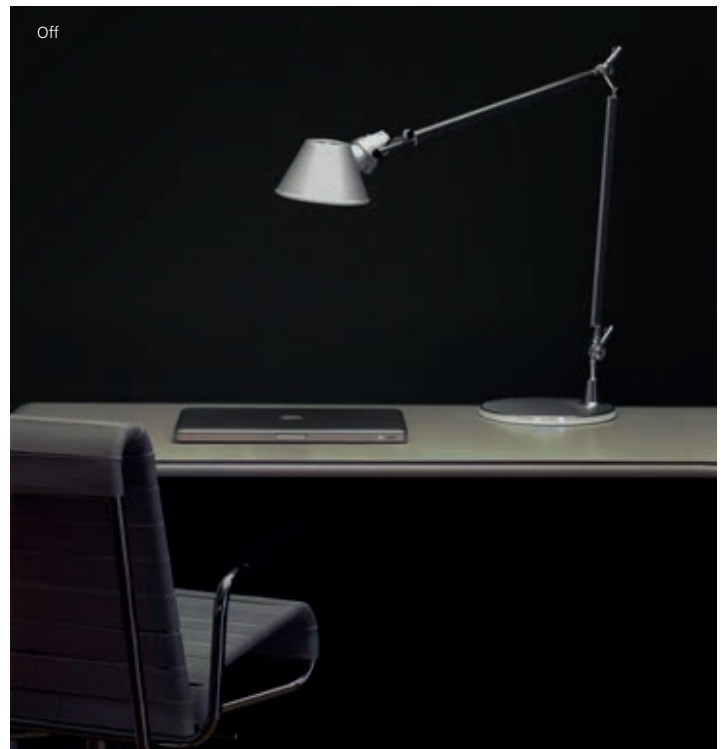
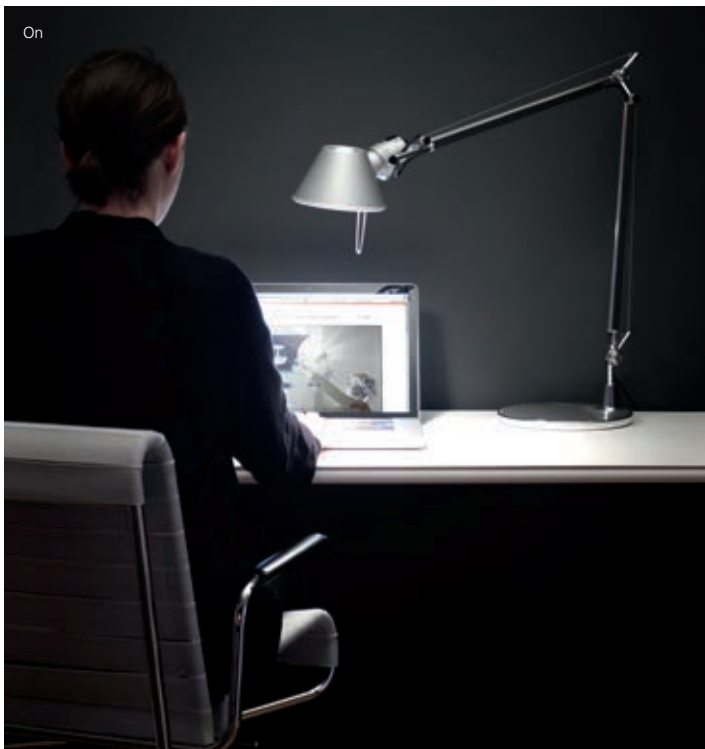

Light emission



Colours



Materiali: base e struttura a bracci mobili in alluminio lucidato; diffusore in carta pergamena o in raso di seta supportato da materiale plastico; snodi in alluminio brillantato.

Specificità: supporto intercambiabile: base, morsetto, perno fisso o doppio che permette di montare due corpi lampada indipendenti. Il diffusore nel normale utilizzo, si dispone verticalmente, indipendentemente dall'angolazione del braccio. Sistema di equilibratura a molle.

Materials: base and cantilevered arms in polished aluminium; diffuser in parchment paper or in silk satin fabric on a plastic frame; joints in polished aluminium.

Matériaux : base et structure à bras articulés en aluminium poli; diffuseur en papier parchemin ou en polycarbonate recouvert de satin de soie ; articulations en aluminium brillant.

Materialien: Sockel und ausrichtbare Arme aus glänzendem Aluminium; Schirm aus mit Kunststoff stabilisiertem Pergamentpapier oder Seidensatin; Gelenke aus poliertem Aluminium.

Materiales: base y estructura con brazos móviles de aluminio pulido; difusor en pergamino o en raso seda reforzado con plástico; articulaciones de aluminio pulido.

Specification: interchangeable support: table base, clamp, desk fixed support and twin support that allows two independent lamp units to be fitted. When used correctly, the shade remains vertical regardless of the angle of the arm. System of spring balancing.

Spécificité : le corps de la lampe peut être associé à une base, à un étau, à un pivot ou à un support qui permet de fixer deux corps de lampe indépendants. Le diffuseur dans le cadre d'une utilisation normale, se place verticalement, indépendamment de la position du bras. Système d'équilibrage à ressorts.

Spezifikation: Auswechselbare Befestigungen: Tischfuß, Klemme, Schraubbefestigung oder fest installierte Montageplatte zur Installation von zwei Leuchtenkörpern. Mit Federausgleichsystem.

Especificaciones: soporte intercambiabile: base de sobremesa, mordaza, perno fijo para escritorio o Twin soporte, que permite montar dos cuerpos de lámpara independientes. En su uso normal, el difusor se dispone verticalmente, independientemente de la inclinación del brazo. Sistema de equilibrio a muelles.

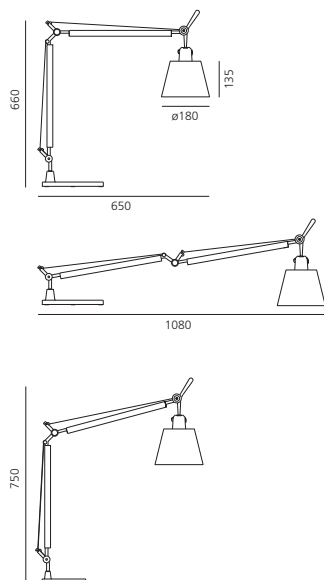

Desk fixed support



Clamp



Table base



HALO max 1x100W (E27)



Energy Label n°6

Tolomeo mega tavolo

design

Michele De Lucchi
Giancarlo Fassina
2004

Light emission



Colours

-  Clamps and arms:
Metal grey
-  Diffuser:
Natural
-  Diffuser:
Grey
-  Diffuser:
Black

Materiali: struttura a bracci mobili in alluminio lucidato; diffusore in carta pergamena, in raso di seta o in tessuto nero supportato da materiale plastico; snodi e morsetto in alluminio brillantato.

Funzionalità: diffusore disponibile in tre dimensioni, orientabile in tutte le direzioni. Sistema di equilibratura a molle.

Materials: cantilevered arms in polished aluminium; diffuser in parchment paper, in silk satin or in black fabric on a plastic frame; joints and clamp in polished aluminium.

Matériaux : structure à bras articulés en aluminium poli ; diffuseur en papier parchemin, ou en polycarbonate recouvert de satin gris ou noir ; articulations et étai en aluminium brillant.

Materialien: Ausrichtbare Arme aus glänzendem Aluminium; Schirm aus mit Kunststoff stabilisiertem Pergamentpapier, Seiden-satin oder Gewebe schwarz Gelenke und Klemme aus poliertem Aluminium.

Materiales: estructura con brazos móviles de aluminio pulido; difusor en pergamino, en raso seda o en tejido negro reforzado con plástico; articulaciones y mordaza de aluminio pulido.

Specification: diffuser, available in three sizes, adjustable in all directions. System of spring balancing.

Spécificité : diffuseur disponible en trois tailles, orientable dans toutes les directions. Système d'équilibrage à ressorts.

Spezifikation: Der Leuchtenkopf, in drei Größen erhältlich, ist in alle Richtungen verstellbar. Federausgleichsystem.

Especificaciones: difusor disponible en tres tamaños, orientable en todas direcciones. Sistema de equilibrado a muelles.

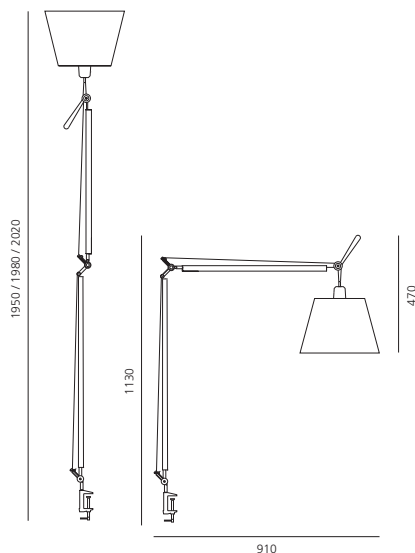
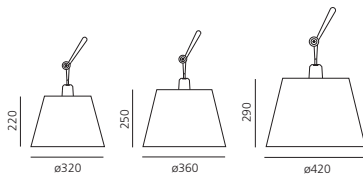

Clamp



Desk fixed support



Tolomeo Mega tavolo LED









LED Total power	31W
Color temperature	3000K
Lighting output natural diffuser	1855lm
Lighting output grey diffuser	1800lm
Lighting output black diffuser	1545lm



- + - Dimmer on chord
- or
- + - Microswitch dimmer

Energy Label n°1

Tolomeo Mega tavolo Halo

HALO max 1x150W (E27)
IP20    
+ - Dimmer
Energy Label n°4
HALO max 1x150W (E27) or FLUO max 1x23W (E27)
Switch on/off
IP20    

Energy Label n°6



Equilibrist

design

Jean Nouvel
2014

Light emission



Colour



White

Materiali: teste in alluminio pressofuso verniciato, bracci in alluminio verniciato, base in zama verniciata.

Specificità: lampada da tavolo con due distinte e contrapposte sorgenti LED da 3W (della testa rotonda) e 9W (della testa quadrata), collocate alle estremità di un braccio a bilanciere. Le due teste, orientabili sia rispetto all'asse verticale che a quello orizzontale, differiscono per forma.

La corrente si trasmette, attraverso i due profili dello stelo centrale, al braccio a bilanciere, alimentando le due teste, che in un continuo saliscendi rimangono in un costante equilibrio dinamico.

Awards

2015 Wallpaper* Design Award

Materiali: head in painted die-cast aluminium; arms in painted aluminium, base in painted zamak.

Matériaux : corps en aluminium moulé sous pression peint ; bras en aluminium verni ; base en métal verni.

Materialien: Leuchtenkopf aus druckgegossenem, lackiertem Aluminium; Arme aus lackiertem Aluminium; Sockel aus lackiertem Zamak.

Materiales: cabeza de la lámpara en aluminio fundido a presión y pintado; brazos en aluminio pintado; Base en zama pintada.

Specification: table lamp with two distinct and opposed 3W (for the round head) and 9W (for the square head) LED sources, located at both ends of a rocker arm. The heads, adjustable both horizontally and vertically, feature a round and a squared shape. The electricity is conveyed via both profiles of the central stem through the rocker arm, feeding the two heads which are both in constant dynamic balance and in a continuous rise and fall movement.

Spécificités : lampe de table avec deux sources LED distinctes et opposées de 3W (tête ronde) et 9W (tête carrée) situées aux extrémités d'un bras balancier. Les deux têtes, orientables aussi bien par rapport à l'axe vertical qu'à l'axe horizontal se différencient par leur forme. Le courant se transmet par le biais de deux profilés de la tige centrale au bras en balancier qui alimentent ainsi les deux têtes qui se positionnent en équilibre dans l'espace.

Spezifikation: Tischleuchte mit zwei unterschiedlichen LED-Quellen von 3W (runder Leuchtenkopf) und 9W (quadratischer Kopf) an den gegenüberliegenden Enden eines Schwingarms. Die beiden Köpfe sind sowohl vertikal als auch horizontal verstellbar und unterscheiden sich in ihrer Form. Der Strom wird den Köpfen, die durch ein ständiges Auf und Ab in dynamischem Gleichgewicht bleiben, durch die Profile des zentralen Stabs und über den Schwingarm zugeführt.

Especificaciones: lámpara de sobremesa con dos fuentes distintas y opuestas LED de 3W (del cabezal redondo) y 9W (del cabezal cuadrado), colocadas en los extremos de un brazo balancín. Los dos cabezales, orientables respecto al eje vertical y al horizontal, que difieren en forma. La corriente se transmite, a través de los dos perfiles del tallo central, al brazo balancín, alimentando los dos cabezales, que permanecen en un continuo arriba y abajo en un equilibrio dinámico y constante.

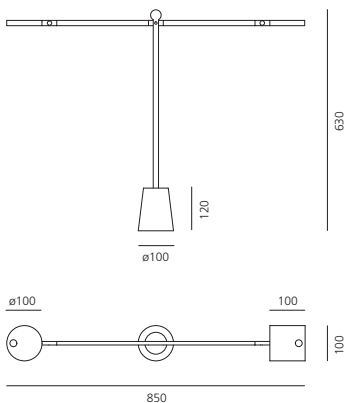

LED Total power 12W
Color temperature 3000K

IP20 ENEC

+ - Microswitch dimmer

Energy Label n°1

Round head
Lighting output 180lm

Square head
Lighting output 310lm



Photo by Elliott Erwitt, Milan, November 2014
Photocamera: Canon model EOS 1N
Black and white film: Kodak Professional Tri-X400







Objective

design

Jean Nouvel
2013

Light emission



Colour



Black

Una lampada da tavolo composta da un volume elementare che si scompone in tre parti per attivare livelli percettivi di comprensione dello spazio, attraverso due sorgenti di luce a LED.

Materiali: corpo della lampada in alluminio estruso con finitura verniciata; diffusore in metacrilato trasparente.

Specificità: la connotazione dell'oggetto, un tubo con l'alloggiamento di diverse ottiche, richiama la manipolazione di un obiettivo fotografico o cinematografico con i diversi segmenti che ospitano tre diverse sorgenti luminose: luce d'ambiente proveniente dal segmento metacrilato semi-opalino; luce puntuale, dalla prima testa, sul piano di lettura o di lavoro; luce puntata verso l'alto dal proiettore della seconda testa.

Awards

2014 - Design Plus, Light+Building Frankfurt am Main (Deutschland)
2015 - IF Product Design Award Deutschland

A table lamp distinguished by a simple shape breaking it down into 3 perfect geometrical volumes to awaken spatial perception on three levels by means of two LED light sources.

Une lampe de table aux formes élémentaires qui se compose en trois parties permettant d'activer des niveaux perceptifs de compréhension de l'espace à travers deux sources de LED.

Ein Zylinder wird in drei Segmente unterteilt, die jeweils eigene Bewegungsmöglichkeiten und Funktionen haben: ein Sockel, ein Glassegment, ein erster Leuchtenkopf sowie ein weiterer Leuchtenkopf.

Una lámpara de sobremesa compuesta por un volumen elemental que se descompone en tres partes para despertar la percepción espacial, a través de dos fuentes de luz a LED.

Materials: lamp body in extruded painted aluminum; diffuser in thermoplastic material.

Matériaux : corps en aluminium extrudé et verni, diffuseur en méthacrylate transparent.

Materialien: Leuchtenkörper aus fließgepresstem Aluminium; Diffusor aus Methacrylat.

Materiales: cuerpo lámpara en aluminio extruido; difusor en material metacrilato transparente.

Specification: the shape of the object – a cylinder containing different sets of optics – recalls the lens of a still or movie camera and its use, with three different segments housing three different light sources: an ambient light produced by the glass segment; a spot light focused, from the first head, onto the work or reading plane; an upward light emitted by the floodlight in the second head.

Spécificités : la connotation de l'objet -un tube avec le logement de différentes optiques- rappelle la manipulation d'un objectif photographique ou cinématographique avec les segments distincts qui hébergent trois effets lumineux : Lumière d'ambiance en méthacrylate semi-opalin Lumière ponctuelle sur le plan de lecture ou de travail Lumière orientée vers le haut à partir du projecteur de la deuxième tête.

Spezifikation: Diese Tischleuchte - eine Röhre mit verschiedenen optischen Elementen - erinnert in ihrer Art und Handhabung an das Objektiv einer Foto- oder Filmkamera; die Einzelemente beherbergen jedoch drei Lichtquellen für unterschiedliche Lichtverteilungen: aus dem Glassegment abgestrahltes Umgebungslicht; punktuell Licht zur Beleuchtung der Arbeitsfläche aus dem ersten Leuchtenkopf; indirektes Licht aus dem zweiten Leuchtenkopf.

Especificaciones: el carácter del objeto –con un tubo que contiene diferentes conjuntos de óptica - recuerda la manipulación de la lente de una cámara fija o película, con los tres segmentos diferentes que albergan tres fuentes de luz diferentes: luz de ambiente que proviene del segmento metacrilato semi-opalino; luz puntual, del primer cabezal, sobre el plano de lectura o de trabajo; luz hacia arriba desde el proyector del segundo cabezal.

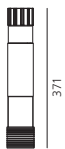

LED Total power 11W
Color temperature 3000K
Dual separate switches



+ Microswitch dimmer

Energy Label n°1

Spot light
Lighting output 270lm

Diffused light
Lighting output 275lm





Lotek

design
Javier Mariscal
2011



Light emission



Colours



Multicolor

Lampada da tavolo a bracci mobili e testa orientabile.

Materiali: base in acciaio verniciato; testa in alluminio verniciato; bracci in alluminio anodizzato.

Table lamp with adjustable arms and head.

Lampe de table à bras mobiles et tête orientable.

Tischleuchte mit verstellbarem Arm und verstellbarem Leuchtenkopf.

Lámpara de sobremesa con brazos móviles y cabeza orientable.

Materials: painted steel base; painted aluminium head; arms in anodized aluminium.

Matériaux : base en acier peint ; tête en aluminium peint ; bras en aluminium anodisé.

Materialien: Tischfuß aus lackiertem Stahl; Kopf aus lackiertem Aluminium; Arme aus eloxiertem Aluminium.

Materiales: base de acero pintado; cabeza de aluminio pintado; brazos de aluminio anodizado.

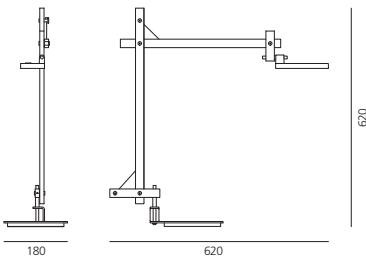

LED Total power 6W
Color temperature 3000K
Lighting output 288lm

IP20 ERAC

- Infrared dimmer

Energy Label n°1



Fiable
Honesto
Racional
Robotizado

contemporaneo

Nueva luz FRÍA

Pesado Básico Antiguo

Soluciones Fáciles Sencillas de toda la vida evidentes

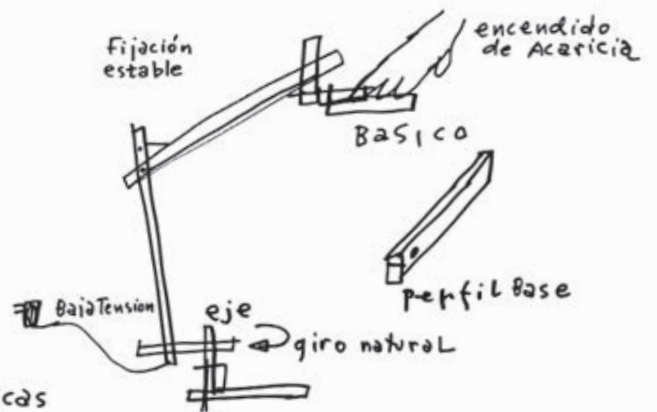

LOTEC Ahorro Energetico
Ahorro tecnologico
Ahorro formal
Reciclar Soluciones Basicas
Movimientos Fáciles, Suaves
Precisos, Múltiples, Expresivos, Nuevos Usos
Pesos compensados
giros naturales



Ipparco

design

Neil Poulton
2012

Light emission



Colour

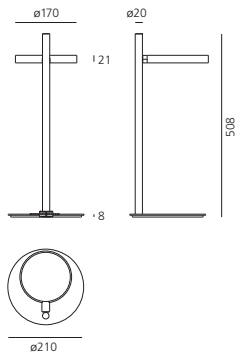
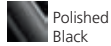

LED Total power 8,5W
Color temperature 3000K
Lighting output 453lm

IP20 ERAC

+ - Microswitch dimmer

Energy Label n°1

Materiali: testa in alluminio pressofuso verniciato; diffusore in metacrilato; base e stelo in acciaio verniciato.

Specificità: lo snodo-calamita permette di posizionare l'anello luminoso su qualsiasi punto della struttura e di orientarlo di 360° sia sull'asse verticale che su quello orizzontale, conferendo la massima flessibilità nel direzionare la luce.

Materials: head lamp in painted die-cast aluminium; diffuser in thermoplastic material; painted steel base and stem.

Specification: the magnet joint enables the user to position the head-ring on any point of the structure and to adjust it up to 360° both on the vertical and the horizontal axis, allowing the maximum flexibility in directing the light.

Matériaux : corps en aluminium moulé sous pression peint ; diffuseur en méthacrylate ; base et tige en acier verni.

Spécificité : l'articulation aimantée permet de déplacer l'anneau lumineux sur n'importe quel point de la structure et de l'orienter à 360° sur l'axe vertical comme sur l'axe horizontal ; ceci donnant la possibilité de diriger la lumière avec la plus grande flexibilité.

Materialien: Leuchtenkörper aus druckgegossenem, lackiertem Aluminium; Diffusor aus Methacrylat; Sockel und Leuchtenstab aus Stahl.

Spezifikation: Über ein Magnet-Gelenk kann der Leuchtenkopf an jeder beliebigen Stelle des Stabs befestigt werden und ist darüber hinaus um 360° sowohl auf der senkrechten als auch auf der waagrechten Achse schwenkbar. Hierdurch wird eine maximale Flexibilität garantiert.

Materiales: cabeza de la lámpara en aluminio fundido a presión y pintado; difusor en material metacrilato; base y tija en acero pintado.

Especificaciones: gracias a la articulación-imán, es posible ubicar el anillo luminoso en cualquier punto de la estructura y orientarlo a 360°, ya sea en torno al eje vertical u horizontal. Así, se obtiene una flexibilidad máxima a la hora de orientar la luz.





Halo

design

Karim Rashid
2011

Light emission



Colour



White

Materiali: base in alluminio pressofuso verniciato; stelo in acciaio verniciato; diffusore in policarbonato trasparente e gomma siliconica;
Specificità: l'impiego di uno snodo centrale permette di impugnare direttamente il diffusore e orientarlo sul piano verticale tra 0 e 90°. Il flusso dei LED è costante e uniforme lungo tutto l'anello luminoso.

Awards

2012 - IF Product Design Award
Hannover (Deutschland)

Materials: painted die-cast aluminium base; steel stem; polycarbonate and silicone rubber diffuser.

Matériaux : base en aluminium moulé sous pression et verni ; tige en acier verni; diffuseur en polycarbonate et silicone.

Materialien: Sockel und Stab aus druckgegossenem Aluminium; Stab aus Stahl; Schirm aus Polycarbonat und Silikongummi.

Materiales: base de aluminio fundido a presión; tija en acero pintado; difusor de policarbonato y goma siliconada.

Specification: thanks to the central joint the user can handle the light halo and adjust it vertically from 0 to 90 degrees. The LED flux is constant and uniform along the whole light halo.

Spécificité : l'emploi d'une rotule centrale permet d'empoierner le diffuseur directement et de l'orienter à la verticale entre 0 et 90°. Le flux des LED est constant et uniforme dans tout l'anneau lumineux.

Spezifikation: Der zentrierte Stab ermöglicht die variable vertikale Positionierung des Leuchtenkopfs von 0° bis 90°. Der Lichtstrom der LED entlang des gesamten Rings ist konstant und gleichmäßig.

Especificaciones: el uso de un nudo central le permite mantener directamente el difusor y orientarlo hacia el plano vertical entre 0 y 90°. El flujo de los LED es constante y uniforme a lo largo de todo el anillo luminoso.

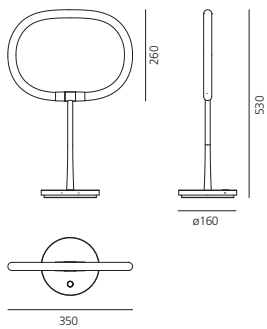

LED Total power 13,5W
Color temperature 4000K
Lighting output 1140lm

IP20 + Touch Dimmer

Energy Label n°1





Itis

design

Naoto Fukasawa
2006

Light emission



Colours

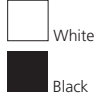

Materiali: base in zama verniciata; stelo in metallo verniciato; testa in metallo verniciato e policarbonato; diffusore in policarbonato trasparente satinato.
Specificità: due snodi collegano lo stelo rispettivamente alla base e alla testa consentendo l'inclinazione dello stelo da 0° a 90° e l'orientamento della testa di 180°.

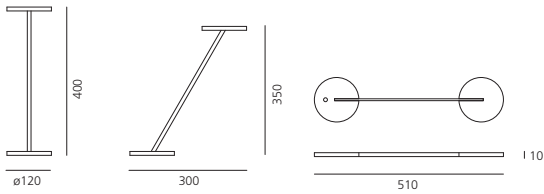

LED Total power 5W
Color temperature 3000K
Lighting output 220lm



+ Microswitch dimmer

Energy Label n°1

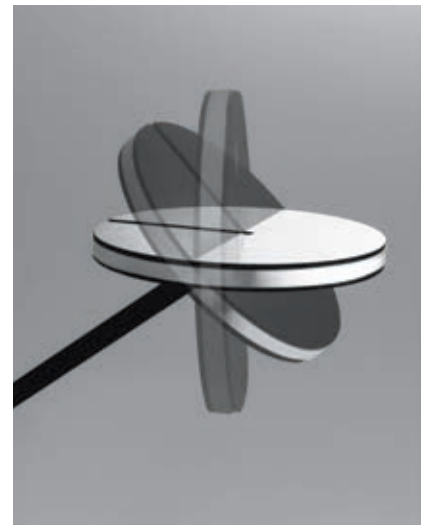



Awards

2007 – Reddot Design “Best of the Best”
Essen (Deutschland)

2007 – Good Design Award
The Chicago Atheneum
Chicago (US)

Museum

Die Neue Sammlung
State Museum of Applied Arts
and Design in the Pinakothek
der Moderne München
(Deutschland)

Materials: painted zamak base; painted metal stem; painted metal and polycarbonate head; satin transparent polycarbonate diffuser.

Specification: two joints connect the stem to the base and the head respectively. The stem can be tilted from 0° to 90° and the head can be rotated up to 180°.

Matériaux : base en zamak peint ; tige en métal peint ; tête en métal peint et polycarbonate ; diffuseur en polycarbonate transparent satiné.

Spécificité : les deux articulations qui relient respectivement la tige à la base et à la tête permettent à la tige de s’incliner de 0° à 90° et à la tête de s’orienter de 180°.

Materialien: Sockel aus lackiertem Zamak; Stab aus lackiertem Metall; Leuchtenkopf aus lackiertem Metall und Polycarbonat; Schirm aus transparentem und satiniertem Polycarbonat.

Spezifikation: Die beiden Gelenke am Sockel und am Leuchtenkopf ermöglichen die Drehung des Schaftes von 0° bis 90° und die Ausrichtung des Leuchtenkopfes um 180°.

Materiales: base de zamak pintado; vástago, de metal pintado; cabeza de metal pintado y policarbonato; difusor de policarbonato transparente satinado.

Especificaciones: las dos articulaciones, que unen el vástago con el pie y con la cabeza respectivamente, permiten inclinar el vástago de 0° a 90° y orientar la cabeza a 180°.



One line

design

Ora Ito
2005, 2007

Light emission



Colours

Body and base:
Silver Grey

Materiali: base in pressofusione di alluminio verniciato; corpo lampada in estruso di alluminio con anima d'acciaio.

Specificità: rotazione del corpo lampada sul piano orizzontale.

Awards

2005 – Reddot Design Award
Essen (Deutschland)

Materials: base in painted die-cast aluminium; body in extruded aluminium, steel internal structure.

Matériaux : base en aluminium moulé sous pression ; corps en aluminium extrudé ; structure interne en acier.

Materialien: Sockel aus Aluminiumdruckguss, Körper aus fließgepresstem Aluminium, Struktur aus Stahl.

Materiales: base en presofusión de aluminio; cuerpo lámpara en estruso de aluminio con "alma" de acero.

Specification: the lamp unit rotates on the horizontal plane.

Spécificité : rotation du corps de la lampe sur le plan horizontal.

Spezifikation: Ausrichtung des Leuchtenkopfes auf der horizontalen Ebene.

Especificaciones: rotación del cuerpo de la lámpara sobre el plano horizontal.

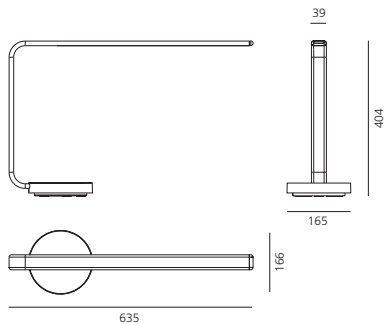

LED Total power 8W
Color temperature 3000K
Lighting output 449lm

IP20 ERC

+ - Microswitch dimmer

Energy Label n°1



Talak tavolo

design

Neil Poulton
2005, 2007

Light emission



Colours

Base, diffuser:
WhiteStem:
Mirror

Awards

2005 – “Observateur du Design”
Etoile 2005 A.P.C.I. – Paris (France)
Design Innovationen Design Zentrum
Nordrhein Westfalen

Reddot Design Award – Product Design
“Best of the Best 2006”
Essen (Deutschland)

Compasso D’oro / A.D.I.
Segnalazione 2008 – Milano (Italia)

Materiali: base in ferro verniciato; morsetto in alluminio brillantato; stelo in acciaio cromato lucido; corpo lampada in resina termoplastica verniciata.

Specificità: con base tavolo o morsetto. Il corpo lampada ruota di 360° sul piano orizzontale ed è regolabile in altezza.

Materials: base in painted iron; clamp in polished aluminium; stem in chromed polish steel; body lamp in painted thermoplastic resin.

Specification: with table base or clamp. The body lamp rotates 360° on the horizontal plane and its height can be adjusted.

Matériaux : base en fer peint ; étau en aluminium poli ; tige en acier poli chromé ; corps en résine thermoplastique vernie.

Spécificité: avec base ronde ou étau. Le corps de la lampe s’oriente jusqu’à 360° sur le plan horizontal et se règle en hauteur.

Materialien: Sockel aus lackiertem Eisen; Klemme aus poliertem Aluminium; Stab aus Stahl, Chrom poliert; Leuchtenkörper aus lackiertem Kunstharz.

Spezifikation: Mit Fuß oder Klemmbefestigung. Der Leuchtenkörper kann horizontal um 360° gedreht werden und ist höhenverstellbar.

Materiales: base en hierro pintado; mordaza en aluminio brillante; tija en acero cromado brillante; cuerpo de la lámpara en resina termoplástica pintada.

Especificaciones: con base de sobremesa o mordaza. El cuerpo de la lámpara gira a 360° en sentido horizontal y es regulable en altura.

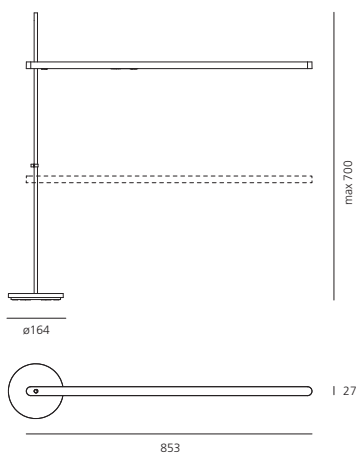

LED Total power 8W
Color temperature 3000K
Lighting output 387lm

IP20

+ - Microswitch dimmer

Energy Label n°1



Fiamma tavolo

design

Jean-Michel Wilmotte
2014

Light emission



Colour



Fiamma è un elemento di luce sistemico, pensato per rispondere a tutte le esigenze del contract, ma che ben si adatta anche a tutti gli ambienti del living quotidiano.

Materiali: corpo della lampada in alluminio estruso modellato meccanicamente per ottenere l'effetto tridimensionale che evoca le forme di una fiamma; stelo in alluminio; base in acciaio verniciato; diffusore in policarbonato trasparente stampato ad iniezione.

Specificità: il cilindro in alluminio estruso è il vero e proprio motore luminoso del sistema. La luce emessa dalla sorgente a LED è sapientemente controllata da un diffusore trasparente, pensato con una texture antiriflesso per creare confort visivo in tutte le situazioni di utilizzo.

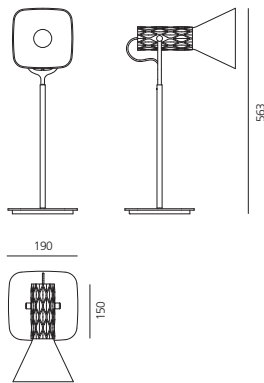

LED max 8W (GU10)

IP20 ERL

Energy Label n°9

Fiamma is a systemic lighting element designed to fulfill the requirements of the contract industry, while at the same time being suitable for every living environment.

Materials: lamp body in extruded aluminum, mechanically moulded to achieve a textured effect evoking the shape of a flame; aluminium stem; painted steel base; transparent injection-moulded polycarbonate diffuser.

Specification: the cylinder in anodized aluminium is the lighting core of the product. The light emitted by the LED source is cleverly controlled by a transparent diffuser, designed with an anti-reflective coating to ensure visual comfort in all usage situations.

Fiamma est un élément de lumière systémique, imaginé pour répondre à toutes les exigences du marché « contract » mais qui s'adapte aussi à tous les espaces à vivre.

Matériaux : corps en aluminium extrudé usiné pour obtenir l'effet texturisé qui rappelle les formes d'une flamme ; tige en aluminium; base en acier verni diffuseur en polycarbonate transparent moulé.

Spécificités : le cylindre en aluminium extrudé représente le véritable moteur lumineux du système. La lumière émise par la source LED est judicieusement contrôlée par un diffuseur transparent imaginé avec une texture anti reflet afin de créer un confort visuel dans tous les contextes d'utilisation.

Fiamma ist ein systemisches Lichtelement, das sich in ein professionelles Ambiente ebenso gut einfügt wie in jedes private Wohnumfeld.

Materialien: Der Leuchtenkörper, dessen mechanisch erzeugte Struktur an eine Flamme erinnert, besteht aus fließgepresstem Aluminium. Struktur aus Aluminium; Sockel aus lackiertem Stahl. Der transparente Schirm aus Polycarbonat ist spritzgegossen.

Spezifikation: Der Zylinder aus fließgepresstem Aluminium bildet das Herzstück des Lichtsystems. Der transparente Schirm mit Antireflex-Struktur lenkt das von der LED Quelle erzeugte Licht dorthin, wo es benötigt wird und gewährleistet ausgezeichneten Sehkomfort.

Fiamma es un elemento e iluminación sistemica diseñado para responder a todas las exigencias del contract, pero que también se adapta a todos los ambientes del living cotidiano.

Materiales: cuerpo de la lámpara en aluminio extruido modelado mecánicamente para obtener el efecto de textura que reclama las formas de una llama; tija en aluminio pintado; base de acero pintado; difusor en policarbonato transparente moldeado por inyección.

Especificaciones: el cilindro de aluminio anodizado es el verdadero motor del sistema luminoso. La luz que emite la fuente de led está controlada por un difusor transparente, diseñado con una textura anti-reflejo, para asegurar el confort visual en todas las condiciones de uso.





Null Vector tavolo

design

Carlotta de Bevilacqua
Laura Pessoni
2013



350

Light emission



Colour



White



Grey



Red



Blue

Materiali: corpo in alluminio forato e tranciato; diffusore in policarbonato satinato texturizzato; base e stelo in acciaio verniciato.

Specificità: il corpo in alluminio è sia la componente strutturale che la parte ottica per il controllo dell'emissione luminosa; la struttura multifaccettata e forata genera un effetto di luce magico che evoca la semplicità e la leggerezza del prodotto.

Materiali: body in punctured and sheared aluminium; diffuser in textured satin polycarbonate; painted steel base and stem

Specification: the aluminium body is both a structural and an optical component to control the light emission; the multi-faceted punctured structure creates a magical lighting effect evoking the simplicity and lightness of the product.

Matériaux : corps en aluminium percé ; diffuseur en polycarbonate satiné texturisé ; base et tige en acier verni.

Spécificités : le corps en aluminium est aussi bien la composante structurelle que la partie optique pour le contrôle de l'émission lumineuse ; la structure multi-facettes percée génère un effet de lumière magique qui évoque la simplicité et la légèreté du produit.

Materialien: Körper aus gelochtem und gestanztem Aluminium; Schirm aus satiniertem, strukturiertem Polycarbonat; Sockel und Struktur aus Stahl.

Spezifikation: Der Aluminiumkörper ist sowohl strukturelle Komponente als auch optisches Gehäuse zur Steuerung der Lichtemission. Die vielschichtige und gelochte Struktur erzeugt einen magischen Lichteffect, der die Einfachheit und Leichtigkeit des Produkts unterstreicht.

Materiales: cuerpo en aluminio perforado y cortado; difusor en policarbonato con textura satinada; Pie y tija en acero pintado.

Especificaciones: el cuerpo de aluminio es tanto una base estructural y un componente óptico para el control de la emisión de luz; la estructura multi-facial y perforada genera un efecto de luz mágico que evoca la simplicidad y la ligereza del producto.

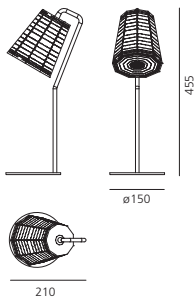

LED max 6W (E14)

IP20 ERC

Energy Label n°9

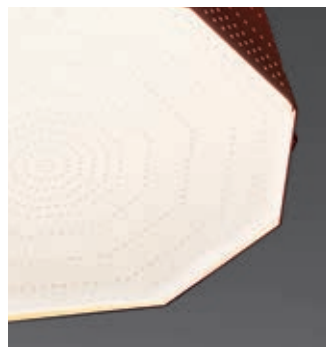

Grey

Red



Blue



White

Melampo tavolo
Melampo notte

design

Adrien Gardère
2000, 2002



Light emission



Colours



Awards

2001 – “Observateur du Design”
Etoile 2001 A.P.C.I. – Paris (France)
2001 – Reddot Design Award
Essen (Deutschland)

Materiali: base in zama verniciata; stelo in alluminio verniciato; diffusore in raso di seta, supportato da materiale plastico.

Specificità: diffusore orientabile in tre diverse posizioni nella versione tavolo e in due diverse posizioni nella versione notte.

Materials: base in painted zamak; painted aluminium stem; diffuser in silk satin fabric on a plastic frame.

Matériaux : base en zamac peint ; tige en aluminium peint ; diffuseur en polycarbonate recouvert de satin de soie.

Materialien: Sockel aus lackiertem Zamak; Stab aus lackiertem Aluminium; Schirm aus Seidensatin (stabilisiert mit Kunststoff).

Materiales: pie de zamak pintado; tija de aluminio pintado; difusor en raso seda reforzado con plástico.

Specification: adjustable diffuser into three different positions in the table version and into two positions in the bedside table version.

Spécificité : diffuseur orientable dans trois positions différentes pour la version de table et dans deux positions différentes pour la version de chevet.

Spezifikation: Der Schirm ist bei der Tischleuchte in drei und bei der Nachttischleuchte in zwei Positionen verstellbar.

Especificaciones: difusor orientable en tres posiciones diferentes en la versión de sobremesa y en dos posiciones en el modelo noche.

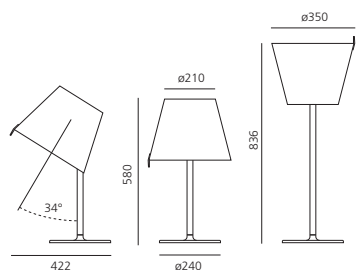

Melampo tavolo

HALO max 2x52W (E27)
or FLUO max 2x15W (E27)
or LED max 2x12W (E27)



Energy Label n°6

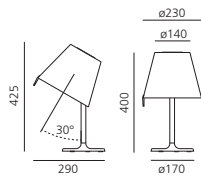

Melampo notte

HALO max 1x46W (E14)
or FLUO max 1x11W (E14)
or LED max 1x6W (E14)



Energy Label n°30



Light emission



Colours

- Base and Stem:
Dark Grey
- Diffuser:
Transparent+Red
- Diffuser:
Transparent+Natural

Materiali: base in zama; struttura in metallo verniciato grigio; diffusore orientabile in policarbonato accoppiato a un foglio di polipropilene serigrafato rosso o da carta pergamena.
Specificità: il diffusore si inclina di 30° e ruota di sul proprio asse di 350°.

Materials: base in zamac, grey painted metal structure, adjustable diffuser in transparent polycarbonate, joined with red silkscreened polypropylene sheet or with parchment paper.

Matériaux : base en zamac ; structure en métal verni gris ; diffuseur orientable en polycarbonate couplé à une feuille de polypropylène sérigraphié rouge ou papier parchemin.

Materialien: Leuchtenfuß aus Zamak; Struktur aus grau lackiertem Metall; verstellbarer Schirm aus Polycarbonat mit rot bedrucktem Polypropylen oder Pergamentpapier.

Materiales: pie de zamac; estructura de metal pintado gris; difusor orientable de policarbonato junto con tejido al polipropileno rojo serigrafado o con tela de pergamino.

Specification: the diffuser tilts 30° and rotates 350° on its axis.

Spécificité : le diffuseur s'incline de 30° et peut pivoter sur son axe à 350°.

Spezifikation: Schirm ist schwenkbar um 30°, drehbar um 355°.

Especificaciones: el difusor se inclina a 30° y gira sobre si mismo hasta 350°.

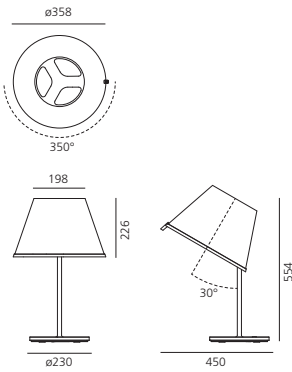

Choose tavolo Fluo

FLUO 1x13W (GX24q-1) – TC-DEL
With electronic ballast



Energy Label n°7

Choose tavolo HALO

HALO max 1x52W (E27)
or LED max 1x14W (E27)



Energy Label n°6



Light emission



Colours



Materiali: base e struttura in alluminio pressofuso; stelo in acciaio; diffusore in alluminio stampato e trattato a specchio.

Materials: die-cast aluminium base and structure; steel stem; moulded and mirror-treated aluminium diffuser.

Matériaux : base et structure en aluminium moulé sous pression ; tige en acier ; diffuseur en aluminium moulé et traité façon miroir.

Materialien: Sockel und Struktur aus druckgegos-senem Aluminium; Stab aus Stahl, Schirm aus Spritzguss und hochglanzpo-liertem Aluminium.

Materiales: pie y estructura en aluminio fundido a presión; tija en acero; difusor en aluminio moldeado por inyección con acabado pulido espejo.

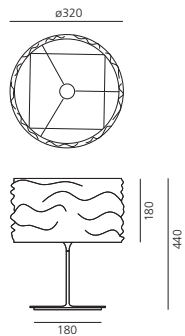

HALO max 1x150W (E27)



+ Touch Dimmer

Energy Label n°4



Ramada Plaza Hotel, Milan (IT) - Ph: Betty Colombo



Dioscuri 14 tavolo
 Dioscuri 25 tavolo
 Dioscuri 35 tavolo
 Dioscuri 42 tavolo

design

Michele De Lucchi
 2000, 2003



Light emission



Colour



White

Materiali: base in resina termoplastica; diffusore in vetro soffiato acidato.

Materials: base in thermo-
 plastic resin, acid-etched
 blown glass diffuser.

Matériaux : base en résine
 thermoplastique, diffuseur
 en verre soufflé traité
 à l'acide.

Materialien: Sockel aus
 thermoplastischem Harz,
 Kugel aus mundgeblasenem
 geätzttem Glas.

Materiales: base de resina
 termoplástica, difusor
 de vidrio soplado al ácido.



Dioscuri 14 tavolo

HALO max 1x48W (G9)
 Lamp included



Energy Label n°18

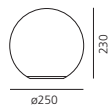

Dioscuri 25 tavolo

HALO max 1x77W (E27)



+ - Dimmer

Energy Label n°4

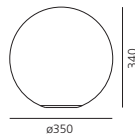

Dioscuri 35 tavolo

HALO max 1x150W (E27)



+ - Dimmer

Energy Label n°4

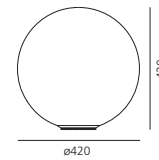

Dioscuri 42 tavolo

HALO max 1x205W (E27)



+ - Dimmer

Energy Label n°4





Dioscuri 25 tavolo

Dioscuri 42 tavolo

Dioscuri 14 tavolo

Dioscuri 35 tavolo

Castore 14 tavolo
 Castore 25 tavolo
 Castore 35 tavolo
 Castore 42 tavolo

design
 Michele De Lucchi
 Huub Ubbens
 2003



Light emission



Colour



White

Materiali: base in zama; stelo in resina termoplastica; diffusore in vetro soffiato acidato.

Specificità: un tasto d'accensione touch, presente sulla base di Castore 25, 35 e 42, permette la regolazione dell'intensità luminosa, la memorizzazione dell'ultimo livello di luce impostato e la possibilità di scegliere tra comando locale e comando remoto (presa comandata).

Awards

2004 – Design Plus, light + building
 Frankfurt am Main (Deutschland)

2004 – Reddot Design Award
 Essen (Deutschland)

2004 – Compasso d'oro / A.D.I.
 Segnalazione – Milano (Italia)

Materials: base in zamak, stem in thermoplastic resin, acid-etched blown glass diffuser.

Matériaux : base en zamak, tige en résine thermoplastique, diffuseur en verre soufflé traité à l'acide.

Materialien: Fuß aus Zamak, Stab aus thermoplastischem Harz, Schirm aus mundgeblasenem, geätztem Glas.

Materiales: base en zamak, tija en resina termoplástica, difusor en cristal soplado al ácido.

Specification: Castore 25, 35 and 42 feature a touch dimmer button on the base of the fitting, which memorizes the latest inputted light intensity and allows the choice of a local or remote control (controlled socket).

Spécificité : Castore 25, 35 et 42 sont dotées d'un variateur sensible situé sur la base, pour la mémorisation du dernier niveau d'intensité lumineuse établi et la possibilité de choisir entre la commande déportée (interrupteur) ou directement sur le luminaire.

Spezifikation: Ein Touch-Dimmer am Fuß der Tischleuchte Castore 25, 35 und 42 ermöglicht die Regelung und die Speicherung der Lichtintensität und bietet außerdem die Möglichkeit, zwischen Hand- und Fernbedienung zu wählen (Steckdosenschalter).

Especificaciones: una tecla que enciende por contacto y que se encuentra en la base de Castore 25, 35 y 42, permite la regulación de la intensidad luminosa y la memorización del último nivel de intensidad configurado y la posibilidad de elegir entre mando exclusivamente local y mando a distancia (toma accionada).

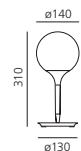

Castore 14 tavolo

HALO max 1x48W (G9)
 Lamp included



Energy Label n°18

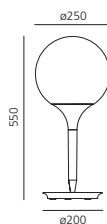

Castore 25 tavolo

HALO max 1x100W (E27)



+ Touch Dimmer

Energy Label n°4

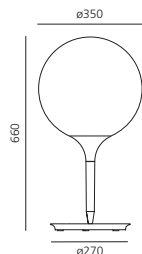

Castore 35 tavolo

HALO max 1x150W (E27)



+ Touch Dimmer

Energy Label n°4

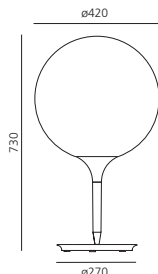

Castore 42 tavolo

HALO max 1x205W (E27)



+ Touch Dimmer

Energy Label n°4

Touch dimmer
 for Castore 25 tavolo,
 Castore 35 tavolo,
 Castore 42 tavolo

Functions:
 1) memo
 2) reset





Castore 42 tavolo

Castore 25 tavolo

Castore 14 tavolo

Castore 35 tavolo

Logico tavolo
 Logico mini tavolo
 Logico micro tavolo

design
 Michele De Lucchi
 Gerhard Reichert
 2001, 2002, 2003

Light emission



Colours



Materiali: struttura in metallo verniciato; diffusore in vetro soffiato con finitura seta lucida.
 Soffiatura a tre strati (cristallo + effetto seta + cristallo) in stampo a fermo con forma capovolta per garantire solidità strutturale del vetro.
Specificità: un tasto d'accensione touch, presente su Logico tavolo e Logico mini tavolo, permette la regolazione dell'intensità luminosa.

Awards

Logico tavolo
 Design Innovationen Design Zentrum
 Nordrhein Westfalen
 2004 – Reddot Design Award
 Essen (Deutschland)

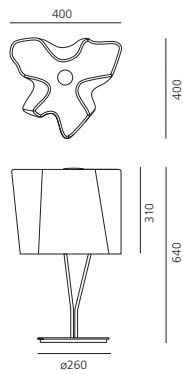

Logico tavolo
 HALO max 3x46W (E27)



+ Touch Dimmer

Energy Label n°4

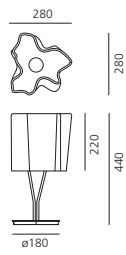

Logico mini tavolo
 HALO max 3x28W (E14)



+ Touch Dimmer

Energy Label n°4

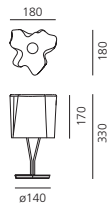

Logico micro tavolo
 HALO max 1x46W (E14)
 or FLUO max 1x11W (E14)
 or LED max 1x6W (E14)



Energy Label n°30



Materials: painted metal structure, blown glass diffuser with polished-silk finish. Three layers blown glass (crystal + silk + crystal) in a mold which is upside down to assure structural consistence to glass.

Specification: Logico tavolo and Logico tavolo mini have a touch dimmer to adjust the light intensity.

Matériaux: structure en métal verni ; diffuseur en verre soufflé, finition soie brillante. Verre soufflé en trois couches (cristal + effet soyeux + cristal) dans un moule qui a une forme inversée pour garantir la solidité structurale du verre.

Spécificité: Logico tavolo et Logico tavolo mini sont dotées d'un variateur sensible, pour agir sur l'intensité lumineuse.

Materialien: Rahmen aus lackiertem Metall; Schirm aus geblasenem Glas in seidig glänzendem Finish. Drei Glasschichten (Kristall + Seide + Kristall) in einer Form, die umgekehrt positioniert ist um die Stabilität des Glases zu gewährleisten.

Spezifikation: Die Versionen Logico tavolo und Logico tavolo mini sind mit einem Touch-Dimmer ausgestattet.

Materiales: estructura de metal pintado; difusor de cristal soplado con acabado de seda brillante. Soplado a tres capas (cristal + efecto seda + cristal) en un molde con forma invertida para asegurar la resistencia estructural del cristal.

Especificaciones: una tecla que enciende por contacto y que se encuentra en Logico tavolo y Logico tavolo mini permite la regulación de la intensidad luminosa.



Touch dimmer

Onfale grande
Onfale medio
Onfale piccolo

design

Luciano Vistosi
1978



Light emission



Colour



White

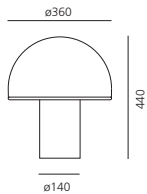

Onfale grande

HALO max 1x77W (E27)
or FLUO max 1x18W (E27)
or **LED** max 1x12W (E27)

+

HALO max 1x18W (E14)
or FLUO max 1x5W (E14)
or **LED** max 1x6W (E14)

IP20   **ERC**

Energy Label n°30

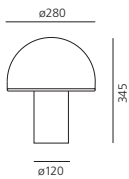

Onfale medio

HALO max 1x46W (E14)
or FLUO max 1x18W (E14)
or **LED** max 1x12W (E14)

+

HALO max 1x18W (E14)
or FLUO max 1x5W (E14)
or **LED** max 1x6W (E14)

IP20   **ERC**

Energy Label n°30

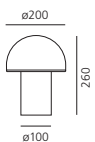

Onfale piccolo

HALO max 1x46W (E14)
or FLUO max 1x18W (E14)
or **LED** max 1x12W (E14)

IP20   **ERC**

Energy Label n°30

Materiali: corpo e diffusore in vetro soffiato opalino; bordo del diffusore in cristallo trasparente riportato a caldo.

Materials: body and diffuser in opaline blown glass. Transparent crystal edge added.

Matériaux : corps et diffuseur en verre soufflé opalin ; bord du diffuseur en cristal transparent appliqué à chaud.

Materialien: Leuchtenkörper aus mundgeblasenem Opalglas; Rand aus transparentem Kristallglas.

Materiales: cuerpo y difusor, de cristal soplado opalino; borde del difusor de cristal transparente, aplicado en caliente.



Light emission



Colours



Base and Stem:
Mirror



Diffuser:
Trasparent

Awards

1998 – BIO 16 – Selection
Ljubljana (Slovenia)

Materiali: base e stelo in metallo cromato lucido; diffusore in vetro soffiato trasparente.

Materials: Base and stem in polished chromed metal, diffuser in transparent blown glass.

Matériaux : Base et tige en métal chromé brillant, diffuseur en verre soufflé transparent.

Materialien: Sockel und Stab aus poliertem und verchromtem Metall, Schirm aus klarem, mundeblasenem Glas.

Materiales: Base y vástago, de metal cromado brillante; difusor en cristal soplado transparente.

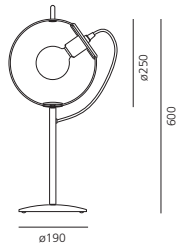

FLUO 1x20W (E27) – globe ø 9cm



Energy Label n°9





Light emission



Colours

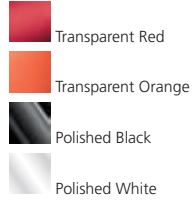

Materiali: materiale termoplastico stampato.

Materials: moulded thermoplastic material.

Matériaux : matériau thermoplastique moulé.

Materialien: Leuchtenkörper aus thermoplastischem Material.

Materiales: material termoplástico estampado.

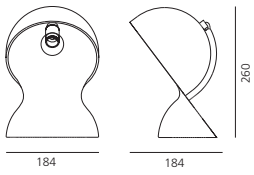

for transparent finishing

HALO max 1x18W (E14)
or FLUO max 1x5W (E14)
or LED max 1x4,5W (E14) opaline



Energy Label n°30

for polished finishing

HALO max 1x28W (E14)
or FLUO max 1x5W (E14)
or LED max 1x6W (E14) opaline



Energy Label n°30



Nessino

design

Giancarlo Mattioli, Gruppo Architetti Urbanisti
Città Nuova
re-edition 2003



Light emission



Colours



Orange



Polished White

Materiali: corpo e diffusore in policarbonato.

Materials: body and diffuser in polycarbonate.

Matériaux : corps et diffuseur en polycarbonate.

Materialien: Körper und Schirm aus Polycarbonat.

Materiales: cuerpo y difusor de policarbonato.

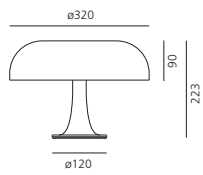

HALO max 4x18W (E14)
or FLUO max 4x5W (E14)
or **LED** max 4x4,5W (E14) opaline



Energy Label n°30



Lampade da terra

Floor lamps
Lampadaires
Stehleuchten
Lámparas de pie



136
Ilio

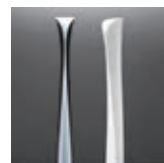

140
Cadmo



142
Solium



161
Tizio supporto
terra



162
Talak lettura



164
Aqua Cil terra



179
Alcatraz



180
Illiria



182
90°



196
Tolomeo terra,
lettura, micro terra



198
Tolomeo
basculante terra,
lettura



200
Tolomeo XXL



144
Florensis terra



146
Mimesi



148
New Nature



150
Reall terra

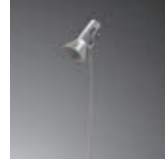

154
Fiamma terra



156
Demetra lettura



158
Objective lettura



160
Megaron terra



165
Cabildo terra



166
Doride

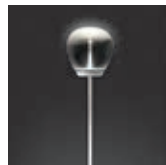

168
Empatia 26 terra



170
Meteorite 35 terra



172
Laguna terra



174
Castore terra

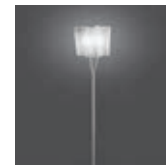

176
Logico terra

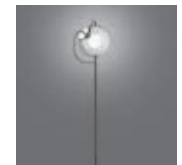

178
Miconos terra



184
Metacolor

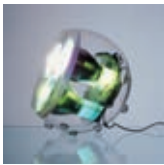

186
Yang



188
Reeds



190
Empirico terra

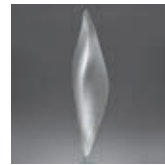

191
Cosmic Leaf terra



192
Melampo terra,
mega terra



193
Choose terra,
mega terra



194
Tolomeo mega
terra

Ilio

design

Ernesto Gismondi
2013

Light emission



Colours



Estrema sintesi geometrica, spogliata di ogni digressione formale e portata all'essenziale, Ilio manifesta la sua presenza attraverso il colore saturo.

Materiali: base in acciaio verniciato; corpo in alluminio estruso verniciato.

With simple geometry, back to basics and stripped of all decorative features, Ilio stands out through the use of saturated colours.

Materials: base in painted steel; lamp body in extruded painted aluminum.

C'est une synthèse géométrique extrême, dépourvue de toute digression formelle réduite à sa plus simple expression. Ilio manifeste toute sa présence à travers la couleur saturée.

Matériaux : base en acier verni; corps en aluminium extrudé et verni.

Extrem geometrisch, befreit von jeder formellen Abschweifung und auf das Wesentliche reduziert, erzielt Ilio ihre Präsenz durch die satten Farben.

Materialien: Sockel aus lackiertem Stahl; Leuchtenkörper aus fließgepresstem Aluminium.

Con una geometría simple, despojado de todas digresiones formales y reducido a sus elementos básicos, Ilio llama la atención por su la saturación del color.

Materiales: base en acero pintado; cuerpo lámpara en aluminio extruido y pintado.

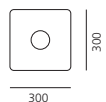
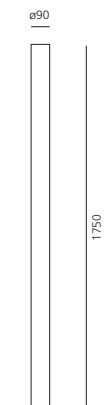

LED Total power 45W
Color temperature 3000K
Lighting output 3564lm

IP20 EAC

+ - Microswitch dimmer

Energy Label n°1



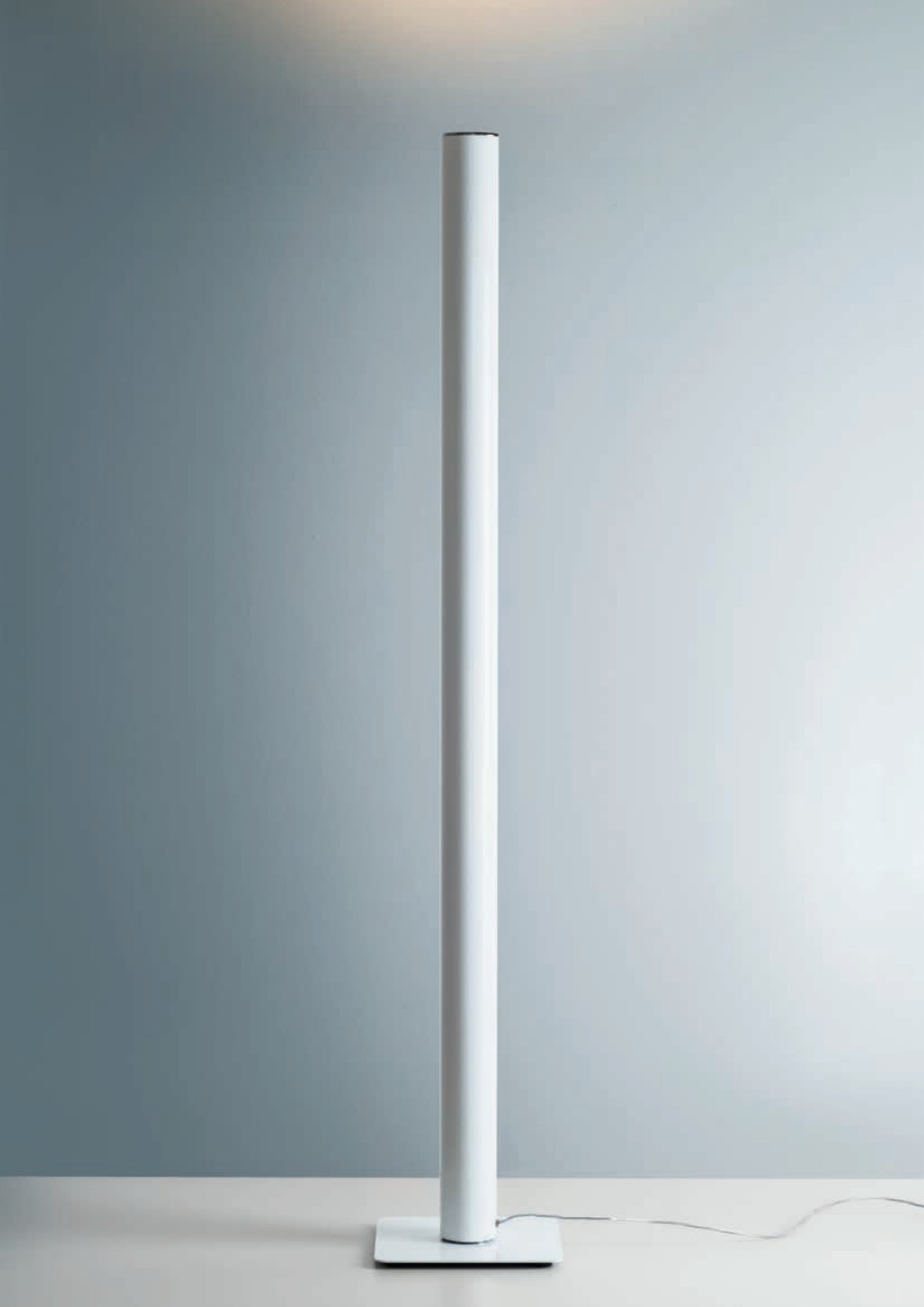





Cadmo

design

Karim Rashid
2006

238

Light emission



Colours



Materiali: corpo lampada in acciaio verniciato, base in acciaio con copribase verniciato.

Materials: painted steel body lamp; inox-steel base with painted cover.

Matériaux : corps en acier verni ; base en acier inox verni.

Materialien: Leuchtenkörper aus lackiertem Stahl; Sockel aus Edelstahl mit lackierter Oberfläche.

Materiales: cuerpo de la lámpara de acero; base de acero inox con cubierta pintada.

Awards

2010 – iF Produkt Design Award
Hannover (Deutschland)
Good Design Award
The Chicago Athenaeum
Chicago (US)

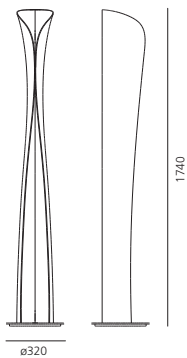

Cadmo LED

Indirect emission:

LED Total power 44W
Color temperature 3000K
Lighting output 3000lm
Dimmable

Diffused emission:

LED max 10W (GU10)
Lamp included
Not dimmable

IP20 ERC

+ Dimmer

Energy Label n°26

Cadmo Halo

Indirect emission:

HALO max 1x230W (R7s)
Lamp included
Dimmable

Diffused emission:

INC max 1x60W (E27) – R63 reflector
Lamp included
Not dimmable

IP20 ERC + Dimmer

Energy Label n°12





Solium

design

Karim Rashid
2013

Light emission



Colours



White

Awards

2015 - Reddot Award
Essen (Deutschland)

Con un unico materiale e un unico momento produttivo si genera una sintesi tra la struttura e l'ottica.

Materiali: corpo lampada stampato in poliuretano con finitura verniciata; base in acciaio verniciato.

Specificità: il corpo della lampada svolge la funzione di riflettore e accoppiato con un'ottica dedicata, permette di performare una luce diffusa con grande efficienza.

From a manufacturing process of a single material, a fusion of frame and optical unit.

Un seul matériau et un seul procédé d'usinage génèrent une synthèse entre structure et optique.

Ein einziges Material verarbeitet in einem einzigen Produktionsschritt lässt eine Synthese zwischen Struktur und Optik entstehen.

Con un único material y un único proceso productivo se genera una síntesis entre la estructura y la óptica.

Materials: lamp body in painted polyurethane; base in painted steel.

Matériaux : corps en polyuréthane verni ; base en acier verni.

Materialien: Leuchtenkörper aus lackierter Polyurethan; Sockel aus lackiertem Stahl.

Materiales: cuerpo de la lámpara en poliuretano pintado; Base en en acero pintado.

Specification: the lamp body works as a reflector which, together with a dedicated optical unit, achieves a high efficiency while diffusing light.

Spécificités : le corps garantit une fonction de réflecteur et associé avec une optique dédiée, permet d'améliorer la performance par le biais d'une lumière diffuse et efficace.

Spezifikation: Der Leuchtenkörper fungiert als Reflektor und erzeugt in Verbindung mit einer speziell entwickelten Optik diffuses Licht von hoher Effizienz.

Especificaciones: el cuerpo del aparato en sí funciona como un reflector que, junto con una unidad óptica, se traduce en una alta eficiencia de difusión de luz.

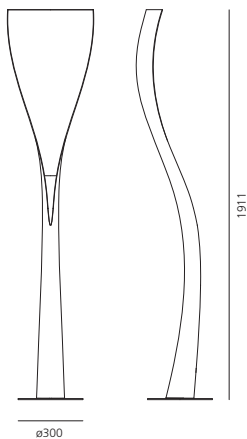

LED Total power 37W
Color temperature 3000K
Lighting output 1750lm

IP20  EAC

 Dimmer

Energy Label n°1





Florensis terra

design

Ross Lovegrove
2013

224

Light emission



Colours



Grey



Black

Florensis si declina nella versione da terra dimmerabile e in quella da parete.
Materiali: testa in alluminio estruso e verniciato; base in zama verniciata; stelo in acciaio verniciato.

Specificità: la testa della lampada, realizzata con un processo fortemente innovativo, svolge sia una funzione estetica che tecnologica, diffondendo luce indiretta e favorendo la dissipazione termica.

Florensis is available as a dimmable floor and non dimmable wall version.

Materials: head in extruded and painted aluminium; base in painted zamak; stem in painted steel.

Specification: the lamp-head, manufactured through a highly innovative process and with a unique organic design, features both an aesthetic and a technological function by diffusing indirect light and operating as heatsink.

Florensis se décline en version lampadaire avec variation et en version applique.

Matériaux : tête en aluminium extrudé et verni; base en métal verni ; tige en acier verni.

Spécificités : la tête de la lampe réalisée avec un processus fortement novateur a aussi bien une fonction esthétique que technologique diffusant une lumière indirecte et participant à la dissipation de la chaleur.

Florensis ist als dimmbare Stehleuchte und als Wandleuchte erhältlich.

Materialien: Leuchtenkopf aus fließgepresstem Aluminium; Sockel aus lackiertem Zamak; Stab aus lackiertem Stahl.

Spezifikation: Der Leuchtenkopf wird in einem hochinnovativen Verfahren hergestellt. Er hat ästhetische und technische Funktion zugleich, indem er indirektes Licht streut und als Wärmeableitung dient.

Florensis se presenta en la versión de pie regulable y en la de pared.

Materiales: cabeza en aluminio anodizado y pintado; base en zama pintada, tija en acero pintado.

Especificaciones: la cabeza de la lámpara, realizada con un proceso muy innovador, desarrolla ya sea una función estética que tecnológica, difundiendo luz indirecta y colaborando con el aire favoreciendo la disipación térmica.

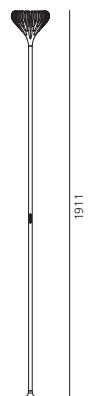

LED Total power 44W
Color temperature 3000K
Lighting output 2710lm

IP20  EAC

+  - Touch Dimmer

Energy Label n°1





Mimesi

design

Carlotta de Bevilacqua
2011

Light emission



Colour



Mirror

“Luce, spazio architettonico e paesaggio naturale sono gli elementi principali di questo progetto, fondato su principi di riduzione energetica e materica. Attraverso la smaterializzazione dei volumi e la trasparenza mimetica, grazie ad una esile struttura di alluminio riciclato e a un corpo in metacrilato, Mimesi non ostacola la visione, integrandosi silenziosamente con l’ambiente circostante”.

Materiali: base in acciaio lucido; struttura in alluminio brillantato lucido; diffusore in PETG trasparente inciso.

“Light, architectural space and natural landscape are the main elements of this project, based on principles of reduction of energy and materials. Through the dematerialization of volumes and mimetic transparency, and thanks to a slim recycled aluminium structure and methacrylate body, Mimesi does not hinder the vision, but silently integrates with the surrounding environment”.

“La lumière, l’espace architectural et le paysage naturel sont les principaux éléments de ce projet qui se base sur le principe de la réduction de la consommation d’énergie et de matières. À travers la dématérialisation des volumes et la transparence mimétique et grâce à une fine structure de l’aluminium recyclé et à un corps en méthacrylate, Mimesi ne gêne pas la vision et s’intègre silencieusement dans l’espace environnant”.

Das Licht, der architektonische Raum und das natürliche Umfeld sind die Grundpfeiler eines Projekts, das sich auf die Zielsetzungen der Energieersparnis und der weitestgehenden Reduzierung der baulichen Werkstoffe richtete. Durch die Dematerialisierung der Volumen und ein ausgesprochen schlankes, beinahe transparent wirkendes Gerüst aus Recycling-Aluminium und einen eleganten Körper aus Metakryl wird Mimesi niemals zu einem störenden Element im Blickfeld sondern ergänzt sich und verschmilzt auf eine harmonische, vornehm zurückhaltende Weise mit der Umgebung”.

“Luz, espacio arquitectónico y paisaje natural son los elementos principales de este proyecto, fundado en principios de reducción energética y materica. A través de la desmaterialización de los volúmenes y la transparencia mimética, y gracias a una grácil estructura de aluminio reciclado y a un cuerpo de metacrilato, Mimesi no crea obstáculos a la visión y se integra sigilosamente en el ambiente circunstante”.

Materials: base in polished steel; structure in polished aluminium; diffuser in engraved transparent PETG.

Matériaux : base en acier poli; structure en aluminium brillant; diffuseur en PETG transparent gravé.

Materialien: Sockel aus poliertem Stahl, Struktur aus poliertem Aluminium, Diffusor aus graviertem, transparenten PETG.

Materiales: base de acero pulido; estructura de aluminio pulido; difusor de PETG transparente grabado.

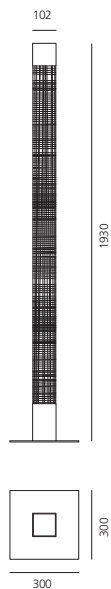

Diffused emission:
LED Total power 3W
Color temperature 6000K (cold white)
Lighting output 100lm

Indirect emission:
LED Total power 42W
Color temperature 3000K (warm white)
Lighting output 2700lm

IP20 EAC

+ Dimmer
(For indirect emission)

Energy Label n°1

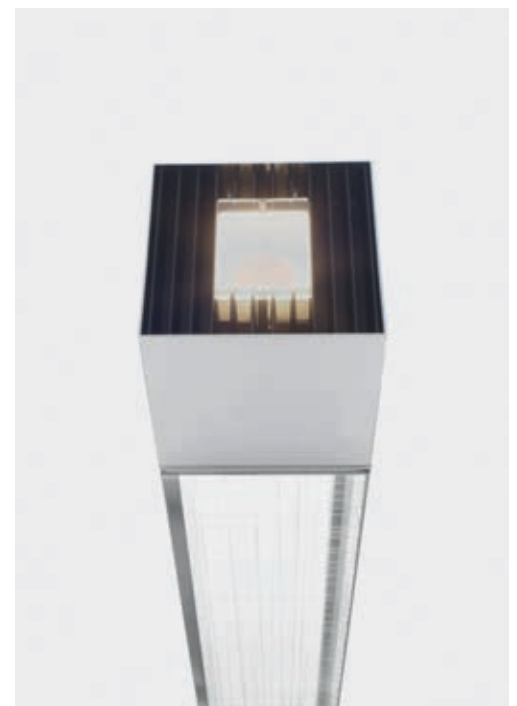
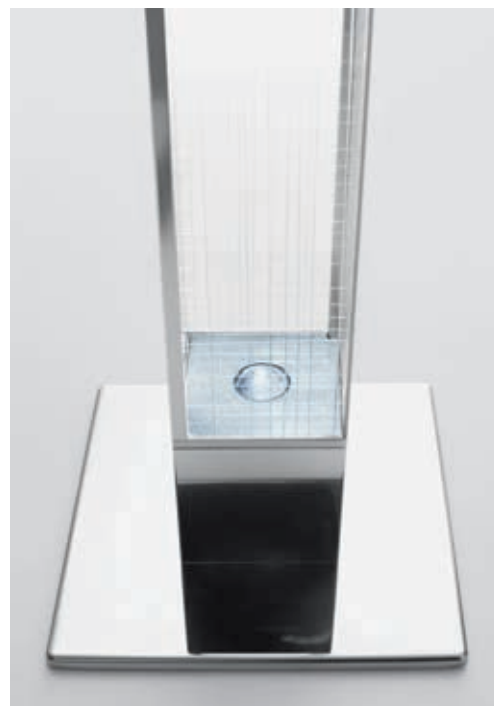

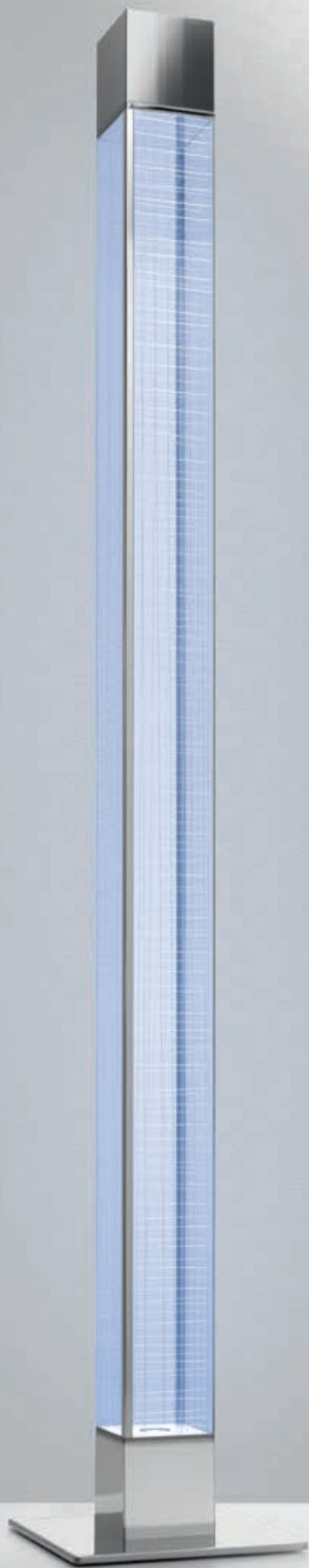



Light emission



Colour



Polished White

“Questo prodotto avanzato di alto valore gioca con geometrie fluide prese in prestito dalla botanica, creando un nuovo tipo di illuminazione nello spazio, gettando sui muri e sulle superfici fasci di luce sovrapposti e ombre, interpretando al meglio il concetto di tridimensionalità”.

Materiali: base in acciaio cromato; corpo illuminante in pressofusione di alluminio con finitura cromata.

Specificità: i LED dell'emissione indiretta principale sono posti nella parte superiore della lampada. I LED dell'emissione secondaria, d'ambiente, sono posti alla base e disegnano l'interno della colonna esaltandone la tridimensionalità. Le due accensioni sono gestibili separatamente.

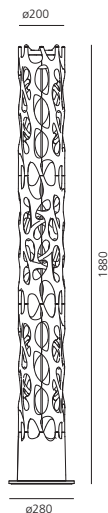

Indirect emission:
LED Total power 42W
Color temperature 3000K
Lighting output 2520lm

Diffused emission:
LED Total power 10W
Color temperature 3000K
Lighting output 300lm

IP20 Dimmer

Energy Label n°1

“This highly developed product of great quality plays with fluid geometries inspired by botanic shapes to define a new kind of light diffusing in space, casting overlapping beams of light and shadow over walls and surfaces in a three dimensional way”.

Materials: chrome-plated steel base, chromed die-cast aluminium lamp body.

Specification: the main indirect emission LEDs are located in the upper part of the fitting. The secondary ambient emission LEDs are located on its base and highlight the three-dimensional inner part of the column. The two switches can be controlled separately.

«Ce produit sophistiqué de grande valeur joue avec des formes géométriques fluides empruntées à la botanique, pour créer un nouveau type d'éclairage dans l'espace qui lance des faisceaux de lumière et d'ombres sur les murs et les surfaces environnantes, interprétant ainsi à merveille le concept de la tridimensionnalité».

Matériaux : base en acier chromé. Corps en aluminium galvanisé chromé.

Spécificité : les LED de l'émission indirecte principale se trouvent dans la partie supérieure de la lampe. Les LED de l'émission secondaire, d'ambiance se situent sur la base et dessinent l'intérieur de la colonne en soulignant ainsi son caractère tridimensionnel. Les deux émissions peuvent être gérées séparément.

“Dieses hochwertige, innovative Produkt spielt mit flüssigen Geometrien der Botanik und definiert eine neue Art des Lichts. Licht und Schatten werden in einer einzigartigen Dreidimensionalität auf Wände und Oberflächen projiziert”.

Materialien: Sockel aus verchromtem Stahl. Leuchtenkörper aus Lackierter Aluminiumdruckguss.

Spezifikation: Die LED für den überwiegenden, indirekten Lichtaustritt befindet sich im oberen Teil der Leuchte. Die LED am Sockel, die direktes Licht abgibt, zeichnet das Säuleninnere nach und hebt so dessen Dreidimensionalität hervor. Der indirekte und direkte Lichtaustritt sind getrennt schaltbar.

“Este producto puntero y de gran valor juguetea con geometrías vegetales fluidas, para definir un nuevo tipo de iluminación en el espacio: los haces de luz y las sombras, que se cruzan sobre las paredes y las superficies, plasman el concepto de tridimensionalidad”.

Materiales: pie de acero cromado; cuerpo de la lámpara en aluminio comprimido cromado.

Especificaciones: los LEDs de la emisión indirecta principal están situados en la parte superior de la lámpara. Los LEDs de la emisión secundaria (de ambiente) están instalados en el pie y dibujan el interior de la columna subrayando su tridimensionalidad. Los dos encendidos se manejan por separado.

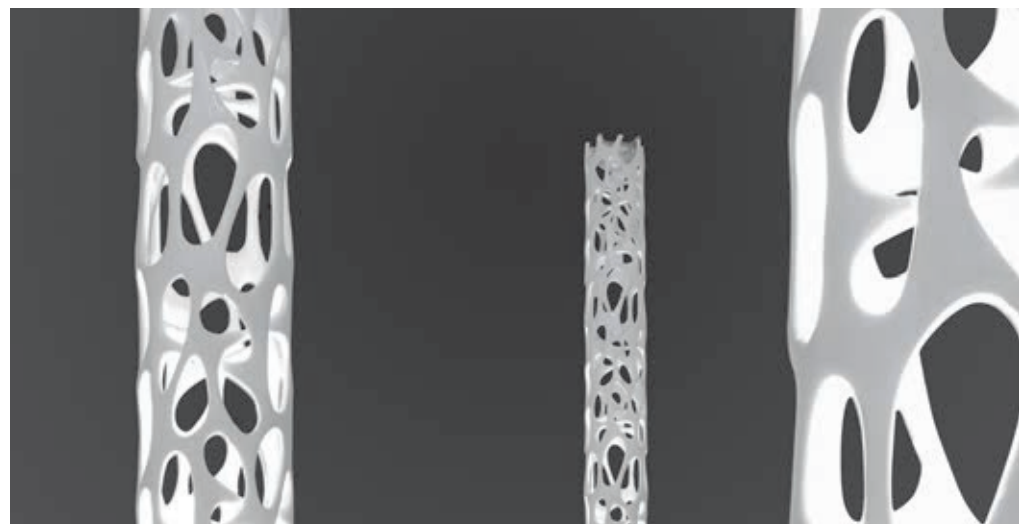

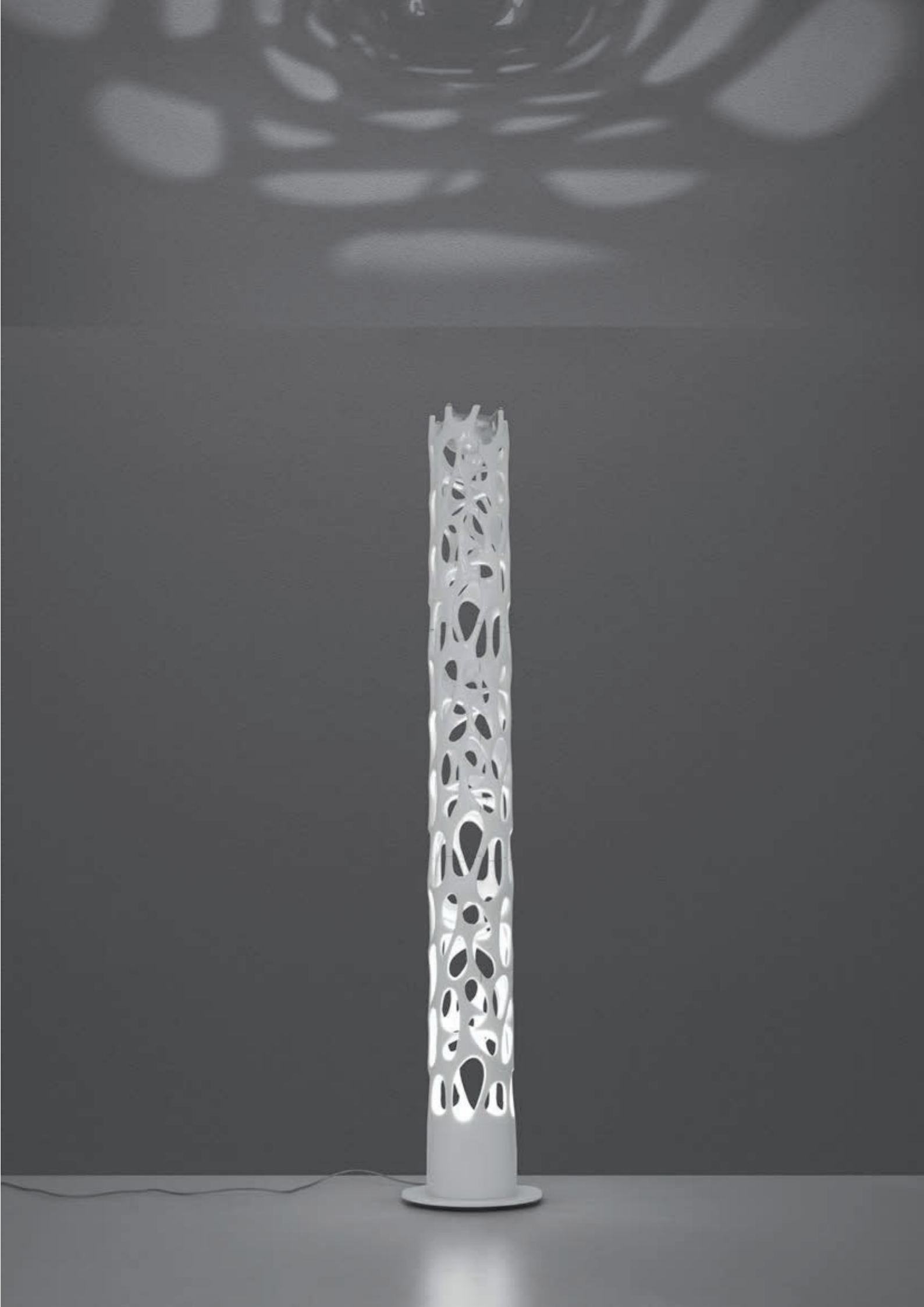

Reall terra

design

Carlotta de Bevilacqua
Paolo Dell'Elce
2011



Light emission



Colour



Stem:
Mirror



Head and base:
Mirror



Head and base:
Polished Black



Head and base:
Polished White

Materiali: pressofusione di alluminio con finitura brillantata lucida o verniciata.

Specificità: un'unica sorgente LED di ultima generazione garantisce gli stessi valori di illuminamento ottenibili con una 400W alogena. Leggerezza visiva e termodinamica sono le caratteristiche principali di questo progetto: la testa pressofusa è opportunamente sagomata e traforata per rappresentare un'interfaccia visiva permeabile nello spazio in cui si colloca e agevolare lo scambio termico della sorgente, garantendone una dissipazione ottimale del calore; essa ruota su due assi e trasla verticalmente sull'asta di supporto, permettendo all'utente di interagire con l'apparecchio e determinare la luce più adatta alle proprie necessità.

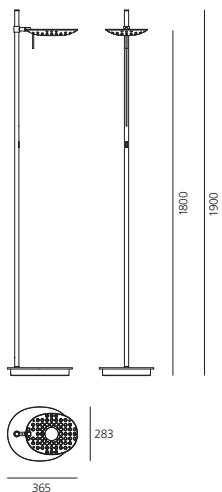

Reall terra

LED Total power 45W
Color temperature 3000K
Lighting output 2631lm

IP20  ERC

+  Microswitch dimmer

Energy Label n°1

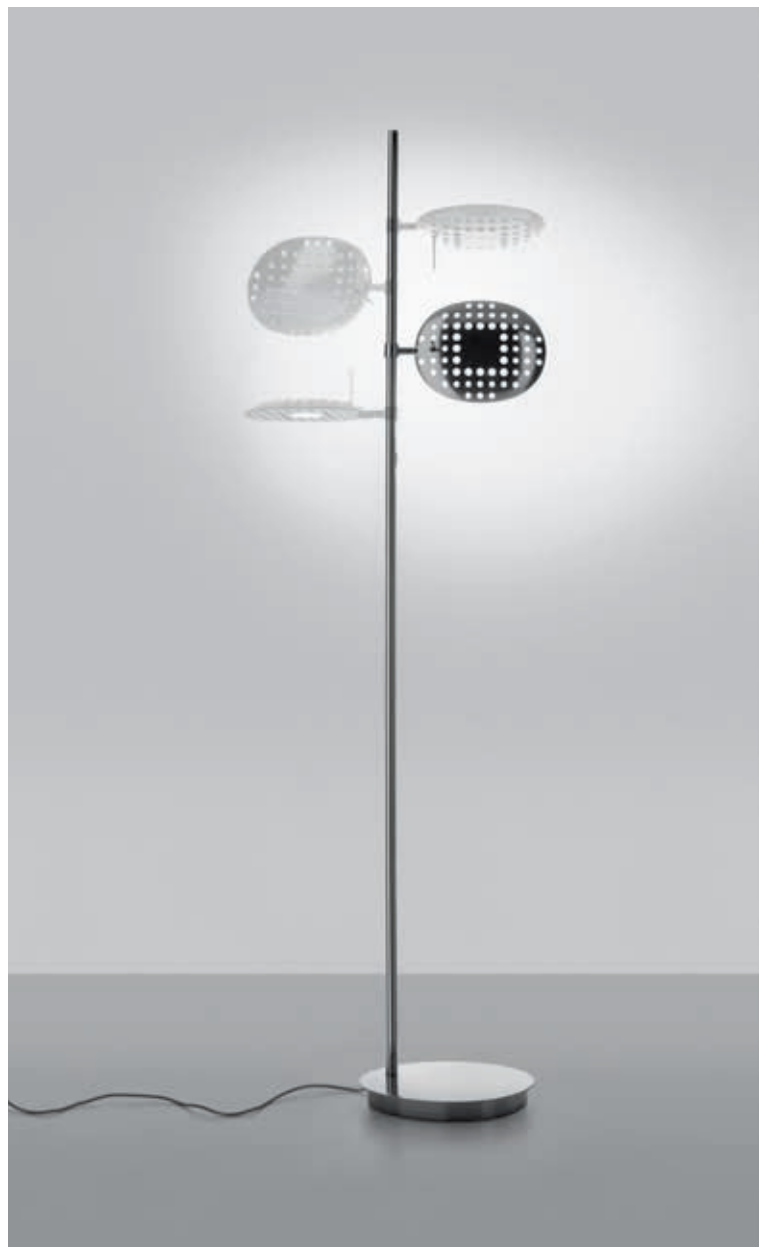





Materials: die-cast aluminium painted or chromed.

Specification: visual lightness and thermodynamics are the main characteristics of this project: the head, made of die-cast aluminium, is appropriately shaped and perforated to form a permeable visual interface for the space where it is placed and facilitates heat exchange, guaranteeing optimum dissipation of the heat produced by the light source; it rotates on two axes and moves vertically on its stem, allowing users to interact with the device and to determine easily the light most suited to your needs. A single latest-generation LED light source guarantees the same illuminance values that are obtainable with a 400W halogen.

Matériaux : aluminium galvanisé verni ou chromé.

Spécificité : la légèreté visuelle et la thermodynamique sont les principales caractéristiques de ce projet. La tête, réalisée en aluminium moulé sous pression, est judicieusement profilée et ajourée pour constituer une interface visuelle et perméable de l'espace dans lequel elle se situe et faciliter l'échange thermique, en garantissant une dissipation optimale de la chaleur produite par la source. Elle tourne sur deux axes et glisse verticalement sur la tige, ce qui permet à l'utilisateur d'agir sur l'appareil et de trouver aisément la lumière la mieux adaptée à ses propres besoins. Une seule source LED de dernière génération fournit les mêmes valeurs 'éclairage que l'on peut obtenir avec une lampe halogène de 400W.

Materialien: Lackierter oder verchromter Aluminiumdruckguss.

Spezifikation: Die Leuchte besticht durch ihre scheinbare Schwerelosigkeit und durch eine ausgeklügelte Thermodynamik. Das Kopfstück aus speziell geformtem und gelochtem Aluminiumdruckguss schafft eine unterbrechungsfreie visuelle Verbindung mit dem Raum und begünstigt den Wärmeaustausch, so dass eine optimale Wärmeableitung erzielt wird. Die auf zwei Achsen rotierende Lichtquelle kann vertikal längs der Trägerstange versetzt werden und gewährleistet so eine gezielte, den individuellen Anforderungen und Gegebenheiten angemessene Lichtemission. Die Leuchten sind mit einer einzigen LED ausgestattet, die die gleiche Leistung wie eine 400W Halogenlampe erbringt.

Materiales: aluminio comprimido pintado o cromado.

Especificaciones: ligereza visual y termodinámica son las características principales de este proyecto: la cabeza, realizada en aluminio moldeado bajo presión, está oportunamente perfilada y perforada para presentar una interfaz visual permeable del espacio en que se coloca y facilitar el intercambio térmico, garantizando una óptima disipación del calor producido por la fuente; gira sobre dos ejes y se desplaza verticalmente sobre el brazo de soporte, permitiendo al usuario la interacción con el aparato de modo que decida fácilmente la luz más adecuada a sus necesidades. Una única fuente LED de última generación, garantiza los mismos valores de iluminación que se obtienen con una halógena de 400 W.



Fiamma lettura

design

Jean-Michel Wilmotte
2014

Light emission



Colour

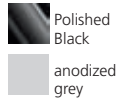

Materiali: corpo della lampada in alluminio estruso modellato meccanicamente; diffusore in policarbonato trasparente stampato ad iniezione; stelo in alluminio; base in acciaio verniciato.

Materials: lamp body in extruded aluminum, mechanically moulded; transparent injection-moulded polycarbonate diffuser; aluminium stem; painted steel base.

Matériaux : corps en aluminium extrudé usiné ; diffuseur en polycarbonate transparent moulé; tige en aluminium; base en acier verni.

Materialien: Der Leuchtenkörper besteht aus fließgepresstem Aluminium; der transparente Schirm aus Polycarbonat ist spritzgegossen; Struktur aus Aluminium Stab; Sockel aus Edelstahl.

Materiales: cuerpo de la lámpara en aluminio extruido modelado mecánicamente; difusor en policarbonato transparente estampado a inyección; tija en aluminio pintado; base de acero pintado.

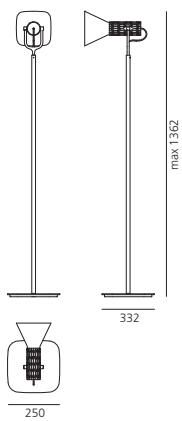

LED max 8W (GU10)

IP20 ERC

Energy Label n°9



Demetra lettura

design

Naoto Fukasawa
2013

Light emission



Colours



Awards

2014 - Design plus
Light+Building Award
Frankfurt (Deutschland)

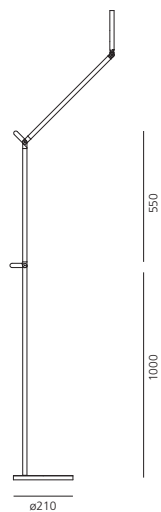

LED Total power 9,5W
Color temperature 3000K
Lighting output 392lm



Microswitch dimmer

Energy Label n°1

Materiali: corpo della lampada in pressofusione di alluminio verniciato; bracci e snodi in alluminio con finitura verniciata; base in acciaio con copribase verniciato.

Demetra lettura MD: in questa versione è presente un sensore Movement Detector, che gestisce l'accensione dell'apparecchio a seconda della vicinanza dell'utente.

Materials: painted die-cast aluminium body lamp; arms in painted aluminium; inox-steel base with painted cover.

Matériaux : corps en aluminium moulé sous pression peint ; bras en aluminium verni ; base en acier inox verni.

Materialien: Leuchtenkörper aus druckgegossenem, lackiertem Aluminium; Arme aus lackiertem Aluminium; Sockel aus Edelstahl mit lackierter Oberfläche.

Materiales: cuerpo de la lámpara en aluminio fundido a presión y pintado; brazos en aluminio pintado; base de acero inox con cubierta pintada.

Demetra MD: this model features a Motion Detector option detecting moving objects and people and turning the light on or off accordingly.

Demetra MD : cette version est dotée d'un détecteur de mouvement qui gère l'allumage de l'appareil selon la présence ou non de l'utilisateur.

Demetra MD: Diese Version der Tischleuchte ist mit einem Bewegungsmelder ausgestattet.

Demetra MD: en esta versión existe un sensor de Detección de Movimiento: que gestiona el encendido del aparato según la proximidad del individuo.

Dimmer on top



Movement detector





Objective lettura

design

Jean Nouvel
2013

Light emission



Colours



Materiali: corpo lampada in alluminio estruso con finitura verniciata; diffusore in metacrilato trasparente; base in zama con finitura verniciata.

Awards

2015 – iF Product Design Award
Deutschland2014 – Design Plus Light+Building Award
Frankfurt (Deutschland)

Materials: lamp body in extruded painted aluminum; diffuser in thermoplastic material; painted zamak base.

Matériaux : corps en aluminium extrudé et verni, diffuseur en méthacrylate transparent. base en zamak peint.

Materialien: Leuchtenkörper aus fließgepresstem Aluminium; Diffusor aus Methacrylat; Sockel aus lackiertem Zamak.

Materiales: cuerpo lámpara en aluminio extruido; difusor en material metacrilato transparente; base de zamak pintado.

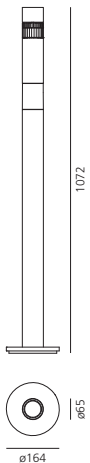

LED Total power 11W
Color temperature 3000K
Dual separate switches

IP20 ERC

+ Microswitch dimmer

Energy Label n°1

Spot light
Lighting output 270lm

Diffused light
Lighting output 275lm





Megaron terra

design

Gianfranco Frattini
1979

Light emission



Colours



Materiali: base in acciaio rivestita con resina termoplastica; corpo in alluminio verniciato o anodizzato lucido.

Materials: steel base coated with thermoplastic resin; body in painted or polished anodized aluminium.

Matériaux : base en acier recouvert de résine thermoplastique ; corps en aluminium verni ou anodisé poli.

Materialien: Standfuß aus Stahl mit thermoplastischem Kunstharz überzogen; Gehäuse aus lackiertem oder glänzend eloxiertem Aluminium.

Materiales: pie de acero, revestido con resina termoplástica; cuerpo de aluminio pintado, o anodizado pulido.

Awards

1981 –Compasso d'Oro / A.D.I.

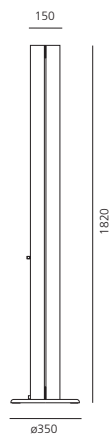
Segnalazione
Milano (Italia)1981 – BIO 9 – Honourable mention
Ljubljana (Slovenia)1987 – Sixth Arango International
Design Exhibition
Miami (US)

Megaron terra LED

LED Total power 45W
Color temperature 3000K
Lighting output 4078lm

IP20 ERC

+ Touch Dimmer

Energy Label n°1

Megaron terra

HALO max 1x400W (R7s)
Lamp included

IP20 ERC

+ Touch Dimmer

Energy Label n°5



Tizio supporto terra
(for Tizio, Tizio LED, Tizio 35, Tizio plus)

design
Richard Sapper
1980



82

Colours

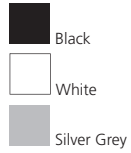

Materiali: alluminio verniciato.

Specificità: supporti terra per il sostegno delle lampade Tizio, Tizio LED, Tizio 35 e Tizio Plus.

Materials: painted aluminium.

Matériaux : aluminium verni.

Materialien: Lackiertes Aluminium.

Materiales: aluminio pintado.

Specification: floor supports for Tizio, Tizio LED, Tizio 35, Tizio Plus fittings.

Spécificité : support pour Tizio, Tizio LED, Tizio 35, Tizio Plus.

Spezifikation: Säule für die Leuchten Tizio, Tizio LED, Tizio 35, Tizio Plus.

Especificaciones: soportes de pie para la sujeción de las lámparas Tizio, Tizio LED, Tizio 35 y Tizio plus.

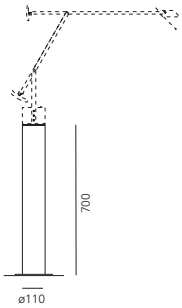

Supporto terra Tizio, Tizio LED, Tizio plus

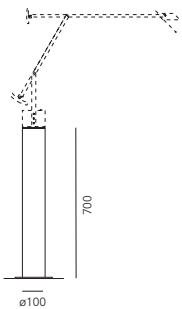

Supporto terra Tizio 35



Talak lettura

design

Neil Poulton
2007

Light emission



Colours

Base, diffuser:
WhiteStem:
Mirror

Materiali: base in ferro verniciato; stelo in acciaio cromato lucido; corpo lampada in resina termoplastica verniciata.

Specificità: il corpo lampada ruota di 360° sul piano orizzontale ed è regolabile in altezza.

Materials: base in painted iron; polished chromed steel stem; body lamp in painted thermoplastic resin.

Matériaux : base en fer peint; tige en acier poli chromé, corps en résine thermoplastique vernie.

Materialien: Sockel aus lackiertem Eisen; Stab aus Stahl, Chrom poliert; Leuchtenkörper aus lackiertem Kunstharz.

Materiales: base en hierro pintado; tija en acero cromado brillante; cuerpo de la lámpara en resina termoplástica pintada.

Specification: The body lamp rotates 360° on the horizontal plane and its height can be adjusted.

Spécificité : le corps de la lampe s'oriente jusqu'à 360° sur le plan horizontal et se règle en hauteur.

Spezifikation: Der Leuchtenkörper kann horizontal um 360° gedreht werden und ist höhenverstellbar.

Especificaciones: el cuerpo de la lámpara gira a 360° en sentido horizontal y es regulable en altura.

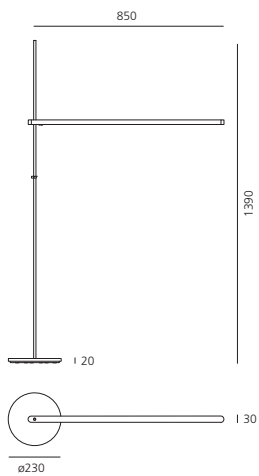

LED Total power 8W
Color temperature 3000K
Lighting output 387lm

IP20 ERC

+ Microswitch dimmer

Energy Label n°1





Light emission



Colours



Materiali: base e struttura in alluminio pressofuso; stelo in acciaio; diffusore in alluminio stampato e trattato a specchio.

Materials: die-cast aluminium ceiling plate, body in moulded aluminium with mirror finish, diffuser in injection-moulded thermoplastic material.

Matériaux : base et structure en aluminium moulé sous pression; tige en acier; diffuseur en aluminium moulé et traité façon miroir.

Materialien: Sockel und Struktur aus druckgegossem Aluminium; Stab aus Stahl, Lichtverteiler aus Spritzguss und hochglanzpoliertem Aluminium.

Materiales: base y estructura en aluminio fundido a presión; tija en acero; difusor en aluminio moldeado por inyección con acabado pulido espejo.

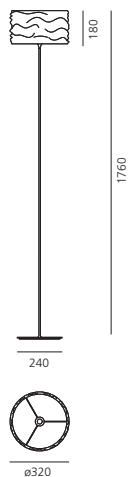

HALO max 1x205W (E27)



+ Touch Dimmer

Energy Label n°4



Cabildo terra

design

Eric Solé
2007



Light emission



Colour



White

Materiali: base e stelo in acciaio; corpo lampada in alluminio pressofuso verniciato.

Awards

2008 – Good Design Award
The Chicago Atheneum
Chicago (US)

Materials: steel base and stem; body lamp in painted die-cast aluminium.

Matériaux : base et tige en acier ; corps en aluminium moulé sous pression peint.

Materialien: Sockel und Stab aus Stahl; Leuchtenkörper aus druckgegossenem, lackiertem Aluminium.

Materiales: pie y tija en acero; cuerpo de la lámpara en aluminio fundido a presión y pintado.

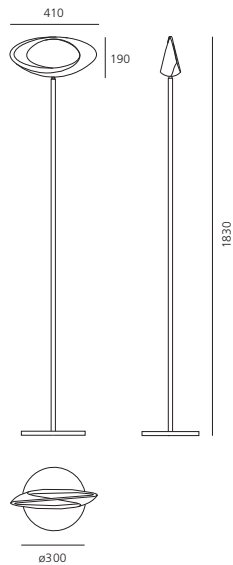

HALO max 1x230W (R7s)
Lamp included

IP20    +  Dimmer

Energy Label n°5





Light emission



Colours

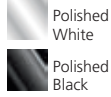

Awards

2009 – Good Design Award
The Chicago Athenaeum
Chicago (US)

2010 – Design Innovationen
Design Zentrum
Nordrhein Westfalen
Reddot Design Award
Essen (Deutschland)

2011 – iF Produkt Design Award
Hannover (Deutschland)

Materiali: base in acciaio; struttura in metallo idroformato; griglia frangiluce antiabbagliamento in materiale termoplastico.

Specificità: lungo lo sviluppo verticale della lampada è presente uno snodo che permette una rotazione sul proprio asse fino a 350°, regolando così l'emissione della luce. Microswitch dimmer posto lungo l'asta.

Materials: Steel base; structure in hydroformed metal; anti-dazzle louvre in thermoplastic material.

Specification: A joint located along the stem allows rotation up to 350° and the adjustment of the light emission in different directions. Microswitch dimmer on the stem.

Matériaux : Base en acier ; structure en métal hydro-formé ; grille anti-éblouissement en matériau thermoplastique.

Spécificité : Le lampadaire se développe verticalement avec une rotation jusqu'à 350° permettant ainsi l'orientation de la lumière et revêtant différentes formes dans l'espace. Variateur sensible placé sur la tige.

Materialien: Sockel aus lackiertem Stahl; Struktur aus hydrogeformten Metall; Blendschutz Gitter aus thermoplastischem Material.

Spezifikation: Ein Gelenk an der vertikalen Achse erlaubt eine Drehung des Leuchtenkopfes um 350°, so kann das Licht in unterschiedliche Richtungen gelenkt werden. Der Microswitch dimmer befindet sich am Sockel.

Materiales: Base metálica; estructura en metal hidroformado; parrilla antideslumbramiento en material termoplástico.

Especificaciones: Un largo cuerpo vertical al final del cual encontramos un nudo que permite la rotación sobre el propio eje hasta 350°, regulando así la emisión de la luz y asumiendo diferentes formas y curvas en el espacio. Encendido para la regulación de la intensidad luminosa colocado a lo largo del asta.

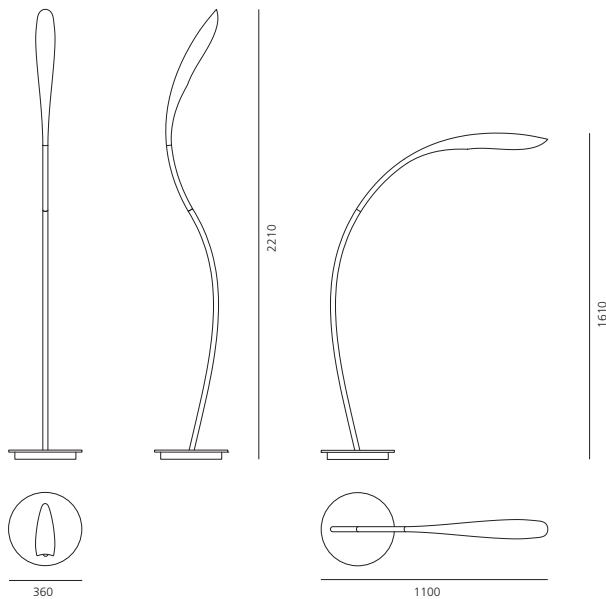

FLUO 1x57W (GX24q-5) – TC-TEL
Lamp included
With electronic ballast



+ - Microswitch dimmer

Energy Label n°35

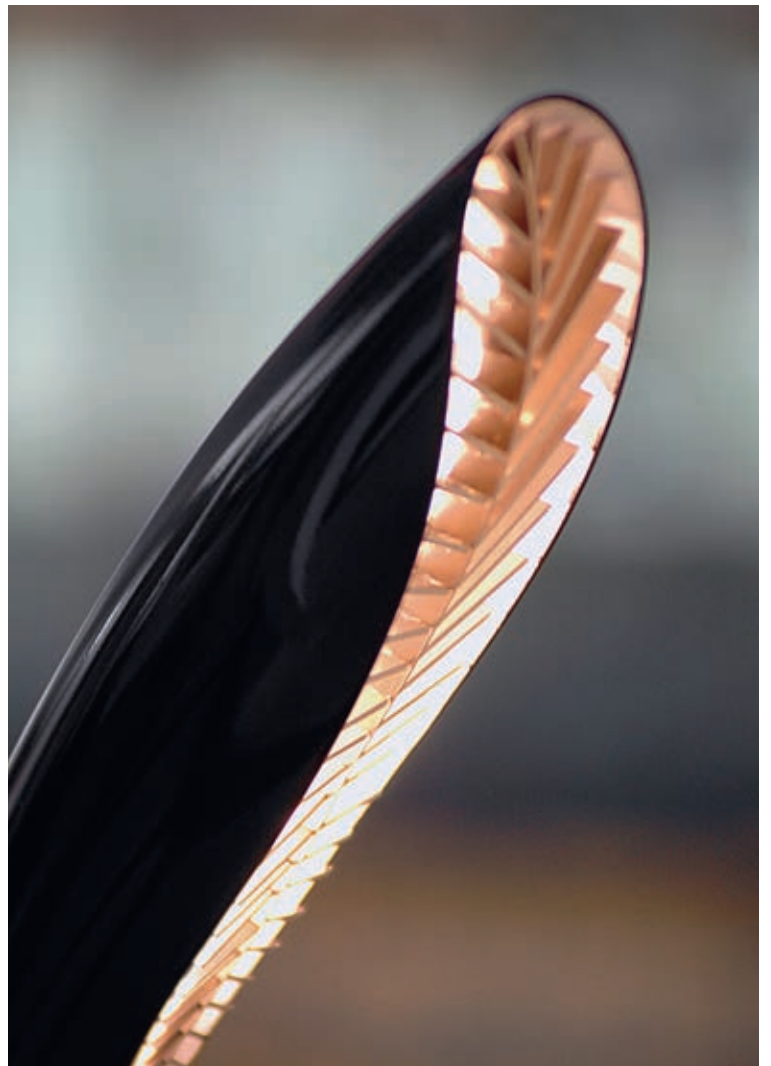



Empatia 26 terra

design

Carlotta de Bevilacqua
Paola di Arianello
2013



Light emission



Colours



White

Awards

2014 – Wallpaper Design Awards
2014 – iF Product Design Award
Deutschland

Materials: painted die-cast aluminium body lamp; arms in painted aluminium; diffuser in blown glass with polished-silk finish; light pipe made of low absorption coefficient methacrylate; glass back plate in painted aluminium; base and stem in painted steel.

Matériaux : corps en aluminium moulé sous pression peint ; diffuseur en verre soufflé transparent avec finition en soie brillante ; guide lumière en méthacrylate à bas coefficient d'absorption ; plaque de fixation du verre en aluminium verni ; base et tige en acier verni.

Materialien: Leuchtenkörper aus druckgegossenem, lackiertem Aluminium; Schirm aus transparentem, mundgeblasenem Glas in seidig glänzendem Finish; Lichtstab aus Methacrylat mit niedrigem Absorptionskoeffizienten; Befestigungsplatte für das Glas aus lackiertem Aluminium; Sockel und Leuchtenstab aus Stahl.

Materiales: cuerpo de la lámpara en aluminio fundido a presión y pintado; difusor en cristal soplado transparente con acabado seda lúcido; guía de luz en metacrilato de bajo coeficiente de absorción; plancha de fijación del cristal en aluminio pintado; pie y tija en acero pintado.

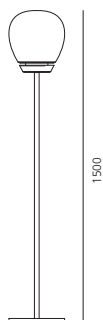

LED Total power 16W
Color temperature 3000K
Lighting output 710lm

IP20   ENEC

+  Touch Dimmer

Energy Label n°1





Light emission



Colours



White

Materiali: diffusore in vetro soffiato; corpo della lampada in tecnopolimero; base e stelo in acciaio.

Materials: blown glass diffuser; lamp body in technopolymer; steel base and stem.

Matériaux: diffuseur en verre soufflé ; corps en techno-polymère; base et tige en acier.

Materialien: Schirm aus mundgeblasenem Glas; Leuchtenkörper aus Technopolymer; Sockel und Leuchtenstab aus Stahl.

Materiales: difusor en cristal soplado; cuerpo de la lámpara en polímero; base y tija en acero.

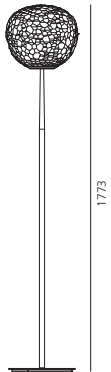

1773



350

HALO max 150W (E27)

IP20 ERC

+ Dimmer

Energy Label n°4



Off



Laguna 16 terra
Laguna 26 terra
Laguna 37 terra

design

Matteo Thun
Antonio Rodriguez
2013



Light emission



Colour



Black brown

Materiali: stelo in estrusione di alluminio; base in acciaio con finitura verniciata; diffusore in vetro soffiato.

Materials: aluminium extruded stem; painted steel base; blown glass diffuser.

Matériaux : tige en aluminium extrudé ; base en acier verni; diffuseur en verre soufflé.

Materialien: Struktur aus fließgepresstem Aluminium; Sockel aus lackiertem Stahl; Schirm aus mundgeblasenem Glas.

Materiales: tija en aluminio extruido; base de acero pintado; difusor en cristal soplado.

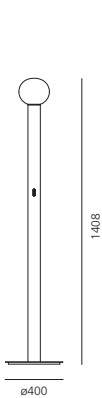

Laguna 16 terra - 140

LED Total power 13W
Color temperature 3000K
Lighting output 539lm



+ Microswitch dimmer

Energy Label n°1



Laguna 16 terra - 180

LED Total power 13W
Color temperature 3000K
Lighting output 539lm



+ Microswitch dimmer

Energy Label n°1

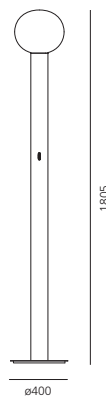

Laguna 26 terra

LED Total power 24W
Color temperature 3000K
Lighting output 1211lm



+ Microswitch dimmer

Energy Label n°1

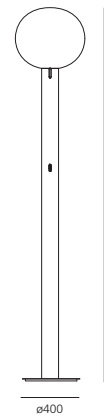

Laguna 37 terra

LED Total power 31W
Color temperature 3000K
Lighting output 1881lm



+ Microswitch dimmer

Energy Label n°1



Laguna 26



Laguna 16 - 140



Laguna 37



Laguna 16 - 180

Castore 35 terra
Castore 42 terra

design

Michele De Lucchi
Huub Ubbens
2003



Light emission



Colour



White

Materiali: base in zama; stelo in resina termoplastica; diffusore in vetro soffiato.
Specificità: un tasto d'accensione touch, presente sullo stelo, permette la regolazione dell'intensità luminosa, la memorizzazione dell'ultimo livello di luce impostato e la possibilità di scegliere tra comando locale e comando remoto (presa comandata).

Awards

2004 – Design Plus, light + building
Frankfurt am Main (Deutschland)

2004 – Reddot Design Award
Essen (Deutschland)

2004 – Compasso d'Oro / A.D.I.
Segnalazione – Milano (Italia)

Materials: base in zamak,
stem in thermoplastic resin,
blown glass diffuser.

Specification: a touch
dimmer button on the
stem memorizes the last
inputted light intensity
and allows the choice of
a local or remote control.

Matériaux : base en zamak,
tige en résine thermoplas-
tique, diffuseur en verre
soufflé.

Spécificité : Castore 35
et 42 sont dotés d'un
variateur sensitif, situé sur
la tige pour la mémorisation
du dernier niveau d'intensité
lumineuse établie et la
possibilité de choisir entre
la commande déportée
(interrupteur) ou
directement sur le luminaire.

Materialien: Fuß aus Zamak,
Stab aus thermoplastischem
Harz, Schirm aus mundgebla-
senem Glas.

Spezifikation: Ein Touch
Dimmer am Stab der Leuchte
ermöglicht die Regelung
sowie die Speicherung der
Lichtintensität und bietet
außerdem die Möglich-
keit, zwischen Hand- und
Fernbedienung zu wählen
(Steckdosenschalter).

Materiales: base en zamak,
tija en resina termoplástica,
difusor en cristal soplado.

Especificaciones: una tecla
que enciende por contacto
y que se encuentra en el
cuerpo, permite la regulación
de la intensidad luminosa
y la memorización del último
nivel de intensidad configu-
rado y la posibilidad de elegir
entre mando exclusivamente
local y mando a distancia
(toma accionada).

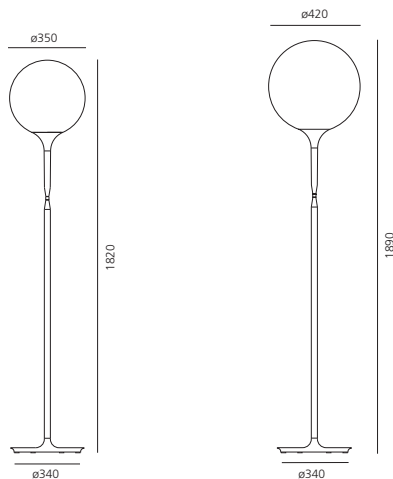

Castore 35 terra

HALO max 1x150W (E27)



+ Touch Dimmer

Energy Label n°4

Castore 42 terra

HALO max 1x205W (E27)



+ Touch Dimmer

Energy Label n°4



Touch dimmer

Functions:
1. Memo
2. Reset



Castore 35 terra

Castore 42 terra

Light emission



Colours

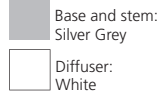

Awards

2002 – Design Innovationen
Design Zentrum Nordrhein Westfalen
Reddot Design Award
Essen (Deutschland)

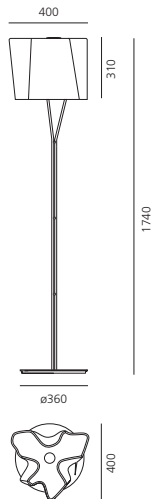

Materiali: struttura in metallo verniciato; diffusore in vetro soffiato con finitura seta lucida. Soffiatura a tre strati (cristallo + effetto seta + cristallo) in stampo a fermo con forma capovolta per garantire solidità strutturale del vetro.

Specificità: un tasto d'accensione touch permette la regolazione dell'intensità luminosa.

Materials: painted metal structure, blown glass diffuser with a polished-silk finish. Three layers of glass (crystal + silk + crystal) are blown in an upside down mould to ensure structural consistence to glass.

Matériaux : structure en métal verni ; diffuseur en verre soufflé, finition soie brillante. Verre soufflé en trois couches (cristal + effet soyeux + cristal) dans un moule qui a une forme inversée pour garantir la solidité structurale du verre.

Materialien: Rahmen aus lackiertem Metall; Schirm aus geblasenem Glas in seidig glänzendem Finish. Drei Glasschichten (Kristall + Seide + Kristall) in einer Form, die umgekehrt positioniert ist, um die Stabilität des Glases zu gewährleisten.

Materiales: estructura de metal pintado; difusor de cristal soplado con acabado de seda brillante. Soplado a tres capas (cristal + efecto seda + cristal) en un molde con forma invertida para asegurar la resistencia estructural del cristal.

Specification: a touch dimmer allows the adjustment of the light intensity.

Spécificité : Logico terra est doté d'un variateur sensible, pour agir sur l'intensité lumineuse.

Spezifikation: ein Touch Dimmer ermöglicht die Einstellung verschiedenster Lichtintensitäten.

Especificaciones: una tecla que enciende por contacto permite la regulación de la intensidad luminosa.

HALO max 3x77W (E27)



+ Touch Dimmer

Energy Label n°4



Light off



Light on



Light emission



Colours



Base and stem:
Mirror



Diffuser:
Transparent

Materiali: base e stelo in metallo cromato lucido; diffusore in vetro soffiato trasparente.

Materials: base and stem in polished chromed metal, diffuser in transparent blown glass.

Matériaux : base et tige en métal chromé brillant, diffuseur en verre soufflé transparent.

Materialien: Sockel und Stab aus poliertem und verchromtem Metall, Schirm aus klarem, mundeblasenem Glas.

Materiales: base y vástago, de metal cromado brillante; difusor en cristal soplado transparente.

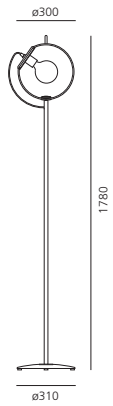

FLUO 1x23W (E27) – globe ø 12cm



Energy Label n°6



Alcatraz

design

Giuseppe Maurizio Scutellà
2011

Light emission



Colour



Polished White

Materiali: base e struttura in metallo verniciato; diffusore in materiale termoplastico stampato ad iniezione; riflettore in alluminio pressofuso.
Specificità: la luce diretta e l'indiretta sono gestibili separatamente da due pulsanti posti sul corpo lampada.

Materials : painted metal base and structure; injection-moulded thermoplastic diffuser; die-cast aluminium reflector.

Specification: direct and indirect light sources can be operated separately by two touch dimmers placed on the body lamp.

Matériaux : base et structure en métal peint ; diffuseur en matière thermoplastique moulée par injection ; réflecteur en aluminium moulé sous pression.

Spécificité : la lumière directe et la lumière indirecte sont gérables séparément grâce à deux variateurs placés sur le corps de l'appareil.

Materialien: Leuchtenkörper und Struktur aus lackiertem Metall; Schirm aus Spritzgussthermoplast; Reflektor aus Aluminium-druckguss.

Spezifikation: Regelung der Beleuchtung durch zwei getrennte Dimmer am Leuchtenkörper.

Materiales: base y estructura de metal pintado; difusor en material termoplástico; reflector en aluminio fundido a presión.

Especificaciones: la luz directa y la indirecta se gestionan separadamente desde dos pulsantes localizados en el cuerpo de la lámpara.

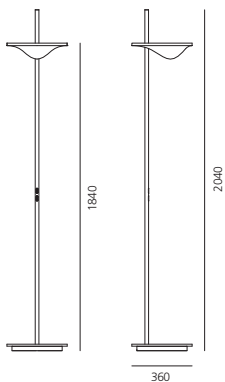
**Indirect emission:**

LED Total power 55W
Color temperature 3000K
Lighting output 3400lm

Direct emission:

LED Total power 15W
Color temperature 3000K
Lighting output 700lm

IP20   +  Microswitch dimmer

Energy Label n°1



Illiria

design

Ernesto Gismondi
2011

Light emission



Colour



Materiali: corpo lampada monomaterico in poliuretano espanso stampato a iniezione.

Specificità: la luce diretta e l'indiretta sono gestibili separatamente da due pulsanti touch posti sul corpo lampada.

Materials: injection-moulded polyurethane foam body.

Matériaux : mousse de polyuréthane moulée par injection.

Materialien: Poliertes Spritzguss-Polyurethan.

Materiales: cuerpo en poliuretano expandido estampado a inyección.

Specification: direct and indirect light sources can be operated separately by two touch dimmers placed on the body lamp.

Spécificité : la lumière directe et la lumière indirecte sont gérables séparément grâce à deux variateurs sensitifs placés sur le corps de l'appareil.

Spezifikation: Regelung der Beleuchtung durch zwei getrennte Touch Dimmer am Leuchtenkörper.

Especificaciones: la luz directa y la indirecta se gestionan separadamente desde dos pulsantes touch localizados en el cuerpo de la lámpara.

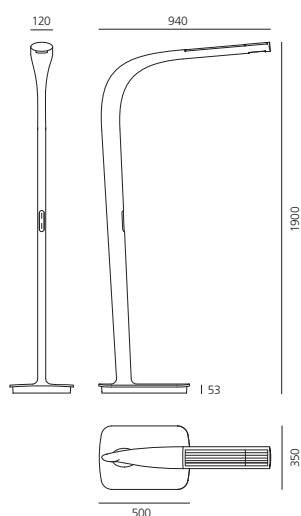

Indirect emission:

LED Total power 36W
Color temperature 3000K
Lighting output 1888lm

Direct emission:

LED Total Power 11W
Color temperature 3000K
Lighting output 698lm

IP20    

+  - Microswitch dimmer

Energy Label n°1





90°

design

Ernesto Gismondi
2013

Light emission



Colours



Lampada da terra con ampia estensione del braccio.

Materiali: base in acciaio verniciato; corpo in estruso di alluminio con finitura verniciata; testa in pressofusione di alluminio verniciato rosso.**Specificità:** la testa della lampada ruota di 55° verso l'alto ed è equipaggiata con due lenti diverse a seconda della versione Home e della versione Office.

Floor lamp with a broad extension of the arm.

Materials: painted steel base; lamp body in extruded painted aluminium; head in red painted die-cast aluminium.**Specification:** the lamphead can be rotated of 55° upwards and is equipped with two different lenses for the Home and Office version.

C'est un lampadaire avec une grande amplitude de bras.

Matériaux : base en acier verni, corps en aluminium extrudé verni, tête en aluminium moulé sous pression verni rouge.**Spécificités :** la tête de la lampe pivote de 55° vers le haut et est équipée de deux lentilles différentes selon la version, home : diffuseuse ou office : darklight.

Stehleuchte mit ausladendem Arm.

Materialien: Sockel aus lackiertem Stahl; Struktur aus fließgepresstem Aluminium; Leuchtenkopf aus rot lackiertem thermoplastischem Material.**Spezifikation:** Der Leuchtenkopf ist um 55° nach oben schwenkbar und ist je nach Home oder Office Version mit zwei unterschiedlichen Linsen ausgestattet.

Lámpara de pie con amplia extensión del brazo.

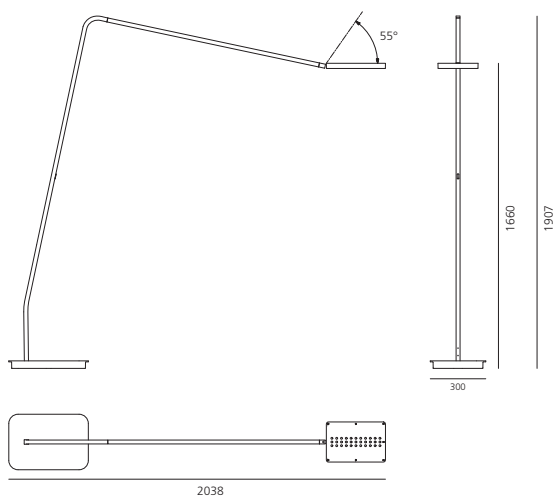
Materiales: Base en acero pintado; cuerpo en aluminio extruido y pintado; cabezal de aluminio comprimido pintado rojo.**Especificaciones:** El cabezal de la lámpara gira hasta 55° hacia arriba y está equipada con dos lentes distintas según sea la versión Home o versión Office.**Home**LED Total power 28W
Color temperature 3000K
Lighting output 2081lm

or

LED Total power 28W
Cold white 4000K
Lighting output 2295lmIP20 +  - Microswitch dimmer

Energy Label n°1

OfficeLED Total power 28W
Color temperature 3000K
Lighting output 2130lm

or

LED Total power 28W
Cold white 4000K
Lighting output 2335lmIP20 +  - Microswitch dimmer

Energy Label n°1







Light emission

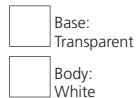

Colours

**Materiali:** acrilico opalino.

Specificità: utilizza sorgenti RGB che consentono di ottenere infinite atmosfere di luce colorata. Attraverso un telecomando è possibile gestire 10 atmosfere standard, crearne e memorizzarne ulteriori 10 e agire sull'intensità luminosa. Un display posto sulla base visualizza l'atmosfera selezionata. In prossimità della base è posta una luce blu di presenza.

Materials: opal acrylic.

Specification: the fitting uses RGB sources allowing the creation of a wide range of coloured light atmospheres. Using a remote control the user can manage 10 standard atmospheres, create and save 10 more and adjust the light intensity. The selected atmosphere can be visualized on a display located on the base of the fitting. A blue light near the base marks the presence of the lamp.

Matériaux : acrylique opalin.

Spécificité : il utilise des sources RGB, qui permettent d'obtenir de nombreuses atmosphères colorées. A l'aide de la télécommande, il est possible de gérer 10 atmosphères standard, d'en créer et d'en mémoriser 10 autres et d'agir sur l'intensité lumineuse. Un écran sur la base, visualise l'atmosphère sélectionnée. Une lumière bleue près de la base signale la présence de la lampe.

Materialien: Opales Acryl.

Spezifikation: Durch den Einsatz von RGB-Lampen lassen sich verschiedenste farbige Lichtstimmung kreieren, die über eine Fernbedienung abrufbar sind (10 Standard-Lichtstimmungen, 10 individuell einstellbare Lichtstimmungen sowie Wahl der Lichtintensität). Ein Display am Sockel visualisiert die ausgewählte Lichtstimmung. Die im unteren Bereich installierte blaue Leuchte signalisiert die Präsenz.

Materiales: acrílico opalino.

Especificaciones: incorpora fuentes de luz RGB, que permiten obtener infinitas atmósferas de luz coloradas. Mediante un mando a distancia es posible manejar 10 atmósferas estándar, crear y memorizar otras 10 y actuar en la intensidad luminosa. Un display contenido en el pie de la lámpara expone la atmósfera seleccionada. Una luz azul marino cerca del pie indica la presencia de la bombilla.

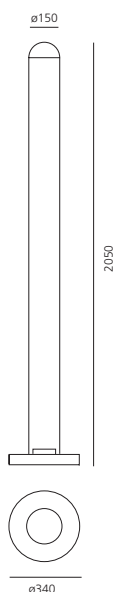

Diffused emission:
FLUO 3 RGBx58W (G13) – T26
Dimmable
With electronic ballast

Presence light:
FLUO 3x9W (G23) blue – TC-S
Lamps included



Energy Label n°24

GOOD MORNING	99% + 99% + 99%
RELAX	20% + 50% + 80%
ENERGY	99% + 40% + 00%
WORKING	60% + 50% + 50%
IDEA	40% + 60% + 00%
BALANCE	40% + 60% + 99%
RELATION	40% + 99% + 50%
PLAY	99% + 00% + 99%
LOVE	99% + 00% + 00%
DREAM	00% + 00% + 99%



Infrared remote control
(included)







Light emission



Colour



Materiali: struttura in metacrilato e policarbonato trasparente.
Specificità: sei piedini permettono di regolare il posizionamento con diverse inclinazioni. Tre proiettori con i filtri dicroici rosso, verde e blu consentono di ottenere infinite atmosfere di luce colorata.
Attraverso un telecomando è possibile gestire 10 atmosfere standard, crearne e memorizzarne ulteriori 10 e agire sull'intensità luminosa. Un display nella lampada visualizza l'atmosfera selezionata.

Materials: methacrylate structure and transparent polycarbonate case.

Matériaux : structure en méthacrylate et polycarbonate transparent.

Materialien: Struktur aus Methacrylat und transparentem Polycarbonat.

Materiales: estructura en metacrilato y policarbonato transparente.

Specification: six small feet allow the lamp to be placed at different inclinations. Three projectors with dichroic filters red, green and blue allow to create a wide range of light coloured atmospheres. It is possible, using a remote control, to manage 10 standard atmospheres, to create and memorise, other 10 and to adjust the light intensity. A display on the lamp shows the selected atmosphere.

Spécificité : six pieds permettent de placer la lampe dans différentes positions. Trois projecteurs avec filtres dichroïques rouge, vert et bleu permettent d'obtenir nombreuses atmosphères de lumière colorées. A l'aide de la télécommande, il est possible de gérer 10 atmosphères standard, d'en créer et d'en mémoriser 10 autres et d'agir sur l'intensité lumineuse.

Spezifikation: Die sechs Füße ermöglichen eine unterschiedliche Positionierung der Leuchte. Drei Strahler mit dichroitischen Filter, in den Grundfarben Rot, Blau und Grün erzeugen unzählige farbige Lichtstimmungen. Über eine Fernbedienung lassen sich 10 Standard-Lichtstimmungen abrufen sowie weitere 10 zur Einstellung der Lichtintensität. Ein Display visualisiert die ausgewählte Lichtstimmung.

Especificaciones: seis piecitos permiten regular la posición con distintas inclinaciones. Tres proyectores con los filtros dicroicos rojo, verde y azul permiten obtener infinitas atmósferas de luz colorada. Mediante un mando a distancia es posible gestionar 10 atmósferas standard, crear y memorizar 10 más y gestionar la intensidad luminosa. Un display en la lámpara visualiza la atmósfera seleccionada.

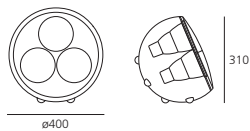

FLUO 3x42W (GX24q-4) – TC-TEL
Dimmable



Energy Label n°28



Infrared remote control
(included)

GOOD MORNING
99% + 99% + 99%

RELAX
20% + 50% + 80%

ENERGY
99% + 40% + 00%

WORKING
60% + 50% + 50%

IDEA
40% + 60% + 00%

BALANCE
40% + 60% + 99%

RELATION
40% + 99% + 50%

PLAY
99% + 00% + 99%

LOVE
99% + 00% + 00%

DREAM
00% + 00% + 99%





Reeds

design

Klaus Begasse
2013

Light emission



Colours

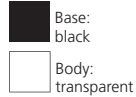

Sette steli flessibili fungono da guida di luce ai LED posti alla base, creando una scenografica presenza luminosa.

Materiali: base in alluminio verniciato, corpo della lampada in policarbonato trasparente ricoperto da una copertura plastica colorata in massa; steli in PMMA trasparente.

Specificità: la forma della base si presta alla componibilità e alla realizzazione di combinazioni multiple personalizzate.

Seven flexible stems work as light tubes for the LEDs located at its base, creating a picturesque lighting trail.

Il s'agit de sept tiges flexibles faisant office de guide lumière aux LED positionnés dans la base, créant ainsi une présence lumineuse scénographique.

Sieben flexible Stäbe dienen als Lichtleiter für die LEDs, die sich am Sockel befinden, und erzeugen eine außergewöhnliche Lichtstimmung.

Siete tallos flexibles sirven de guía de luz a los LED situados en la base, creando una escenográfica presencia luminosa.

Materials: base in painted aluminium; lamp body in transparent polycarbonate covered with a body-tinted plastic cover; stems in transparent PMMA.

Matériaux : base en aluminium verni, corps en polycarbonate transparent recouvert d'une couche en plastique colorée dans la masse ; tiges en PMMA transparent.

Materialien: Sockel aus lackiertem Aluminium; Leuchtenkörper aus Polycarbonat mit Kunststoffabdeckung; Stäbe aus transparentem PMMA.

Materiales: base en aluminio pintado; cuerpo de la lámpara en policarbonato transparente cubierta con una tapa de plástico; tijas en PMMA transparente.

Specification: the shape of the base allows modular installations and multiple customized configurations.

Spécificités : la forme de la base permet de réaliser des combinaisons multiples.

Spezifikation: Die Form des Sockels ermöglicht die Kombination von mehreren Leuchtenmodulen.

Especificaciones: la forma de la base se presta a la composición y a la realización de combinaciones múltiples personalizadas.

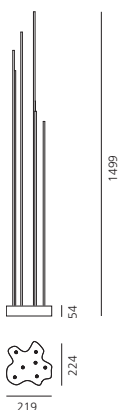

LED Total power 9,5W
Color temperature 3000K
Lighting output 79lm
Electronic power supply included

IP20 ERC

Energy Label n°1





Light emission



Colour



White

Materiali: base e stelo in alluminio verniciato. Diffusore in polietilene neutro stampato in tecnica rotazionale con finitura superficiale lucida.

Materials: painted aluminium base and stem; diffuser in rotationally moulded polyethylene, transparent finish.

Matériaux : base et tige en aluminium; diffuseur en polyéthylène neutre rotomoulé, finition transparent.

Materialien: Sockel und Stab aus lackiertem Aluminium; Schirm aus Polyethylen, hergestellt im Rotations-spritzgussverfahren, transparentes Finish.

Materiales: base y tija de aluminio pintado; difusor en polietileno neutral trabajado mediante moldeo rotacional con acabado transparente.

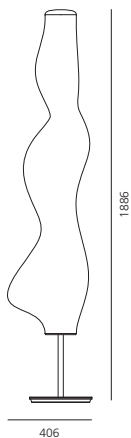

FLUO 2x35W (G5) – T16
Lamp included
With electronic ballast

IP20   Dimmer

Energy Label n°23



Cosmic Leaf terra

design

Ross Lovegrove
2009

316

Light emission



Colours

Diffuser:
TrasparentLighting unit:
Grey

Awards

2010 – Good Design Award
The Chicago Athenaeum
Chicago (US)

Materiali: struttura in acciaio cromato; corpo lampada-diffusore in metacrilato trasparente texturizzato; corpo illuminante in metallo verniciato.

Materials: chromed steel structure; body lamp-diffuser in transparent methacrylate with texture; painted metal lighting unit.

Matériaux : structure en acier chromé ; corps diffuseur en méthacrylate transparent tissé ; corps lumineux en métal peint.

Materialien: Gestell aus verchromtem Stahl, Leuchtenkörper aus transparentem, strukturiertem Methacrylat; Beleuchtungseinheit aus lackiertem Metall.

Materiales: estructura en metal cromado; cuerpo de la lámpara-difusor en metacrilato transparente texturizado, cuerpo luminoso en metal pintado.

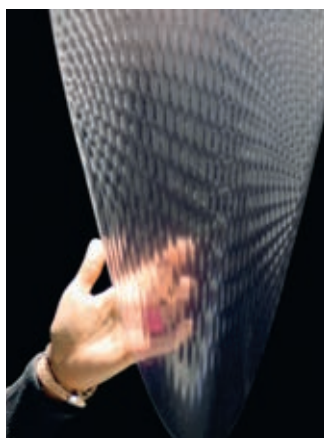
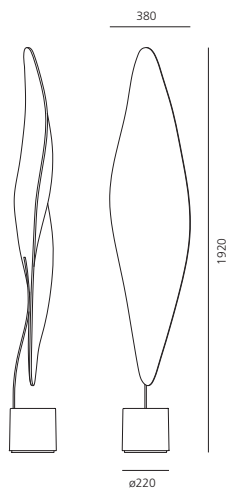

LED Total power 22W
Color temperature 3000K
Lighting output 1500lm

IP20  

Energy Label n°1

HALO 1x100W (G53) – QR111
Lamp included

IP20   

Energy Label n°32

Melampo terra
Melampo mega terra

design
Adrien Gardère
2000, 2005



Light emission



Colours



Materiali: base in zama verniciata; stelo in alluminio verniciato; diffusore in raso di seta, supportato da materiale plastico.
Specificità: diffusore orientabile in tre diverse posizioni.

Materials : base in painted zamak; painted aluminium stem; diffuser in silk satin fabric on a plastic frame.

Matériaux : base en zamak peint ; tige en aluminium peint ; diffuseur en polycarbonate recouvert de satin de soie.

Materialien: Sockel aus lackiertem Zamak; Stab aus lackiertem Aluminium; Schirm aus Seidensatin (stabilisiert mit Kunststoff).

Materiales: pie de zamak pintado; tija de aluminio pintado; difusor en raso seda reforzado con plástico.

Awards

1999 – Design Innovationen
Design Zentrum Nordrhein Westfalen
Reddot Design Award
Essen (Deutschland)

Specification: adjustable diffuser into three different positions.

Spécificité : diffuseur orientable dans trois positions différentes.

Spezifikation: Schirm in drei unterschiedliche Positionen verstellbar.

Especificaciones: difusor orientable en tres posiciones diferentes.

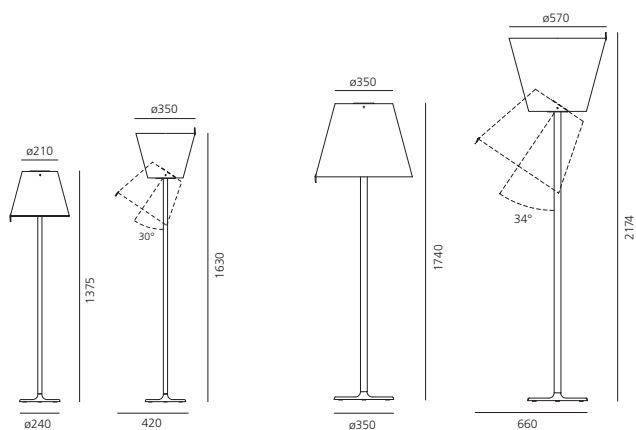

Melampo terra

HALO max 2x52W (E27)
or FLUO max 2x15W (E27)
or LED max 2x12W (E27)



Energy Label n°6

Melampo mega terra

HALO max 2x150W (E27)



+ Dimmer

Energy Label n°4

Silver grey finishing



Bronze finishing



Melampo Mega terra

Melampo terra

Choose terra
Choose mega terra

design
Matteo Thun
2006, 2007



Light emission



Colours

-  Base and stem:
Dark Grey
-  Diffuser:
Transparent + Red
-  Diffuser:
Transparent + Natural

Materiali: base in zama; struttura in metallo verniciato; diffusore orientabile in materiale termoformato accoppiato a un foglio di polipropilene serigrafato rosso o da carta pergamena.

Materials: base in zamak, painted metal structure, adjustable diffuser in thermoformed material joined with red silkscreened polypropylene sheet or with parchment paper.

Matériaux : base en zamak; structure en métal verni ; diffuseur orientable en matériau thermoformé couplé à une feuille de polypropylène sérigraphié rouge ou papier parchemin.

Materialien: Leuchtenfuß aus Zamak; Struktur aus lackiertem Metall; verstellbarer Schirm aus thermogeformtem Polypropylen entweder rot bedruckt oder mit Pergamentpapier.

Materiales: pie de zamak; estructura de metal pintado; difusor orientable de material termoformado con tejido de polipropileno rojo serigráfico o con tela de pergamino.

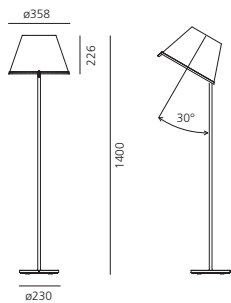

Choose terra Fluo

FLUO 2x13W (G24 q-1) – TC-DEL
With electronic ballast



Energy Label n°7

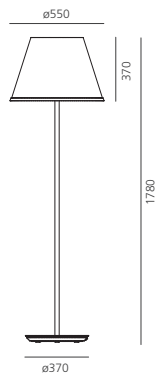

Choose mega terra Fluo

Direct emission:
FLUO 3x18W (G24q-2) – TC-DEL
With electronic ballast

Indirect emission:
INC max 1x100W (E27) – R80 reflector
or
FLUO 1x23W (E27) – SPOT



Energy Label n°14

Choose terra

HALO max 2x52W (E27)
or LED max 2x14W (E27)



Energy Label n°6

Choose mega terra Halo

Direct emission:
HALO max 3x77W (E27)

Indirect emission:
INC max 1x100W (E27) – R80 reflector



Energy Label n°6



Choose Mega terra

Choose terra

Tolomeo mega terra

design

Michele De Lucchi
Giancarlo Fassina
2002

Light emission



Colours

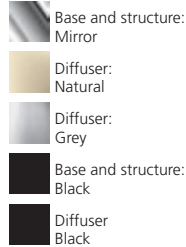

Awards

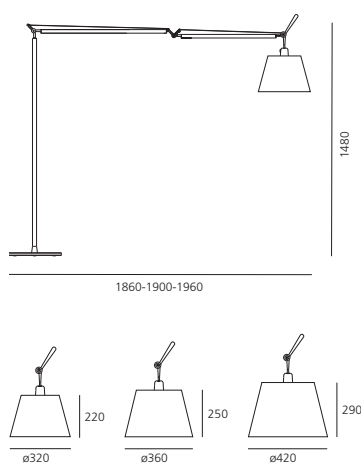
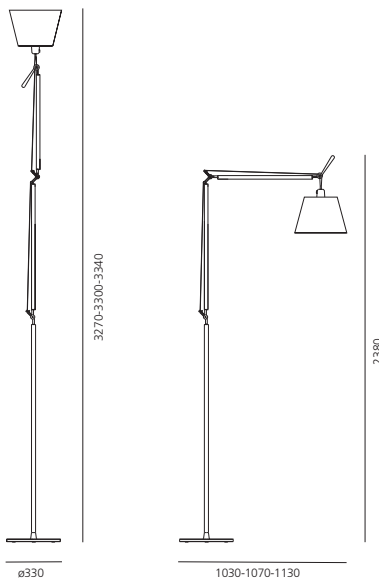
2003 – Reddot Design Award
Essen (Deutschland)

Materiali: base in alluminio lucidato; struttura a bracci mobili in alluminio lucidato; diffusore in carta pergamena o in raso di seta supportato da materiale plastico; snodi in alluminio brillantato.
Specificità: diffusore disponibile in tre dimensioni, orientabile in tutte le direzioni. Sistema di equilibratura a molle.

Materials: polished aluminium base and cantilevered arms; diffuser in parchment paper or in silk satin fabric on a plastic frame; joints in polished aluminium.

Specification: diffuser, available in three sizes, adjustable in all directions. System of spring balancing.

Matériaux : base et structure à bras articulés en aluminium poli ; diffuseur en papier parchemin, en polycarbonate ou recouvert de satin de soie gris ou noir ; articulations en aluminium brillant.

Spécificité : diffuseur disponible en trois tailles, orientable dans toutes les directions. Système d'équilibrage à ressorts.

Materialien: Sockel und ausrichtbare Arme aus glänzendem Aluminium; Schirm aus mit Kunststoff stabilisiertem Pergamentpapier oder Seidensatin; Gelenke aus poliertem Aluminium.

Spezifikation: Der Leuchtenkopf, welcher in drei Größen erhältlich ist, lässt sich in alle Richtungen verstellen. Federausgleichsystem.

Materialien: pie y estructura con brazos móviles de aluminio pulido; difusor en pergamino o en raso seda reforzado con plástico; articulaciones de aluminio pulido.

Especificaciones: difusor disponible en tres tamaños, orientable en todas direcciones. Sistema de equilibrio a muelles.

Tolomeo Mega terra LED

LED Total power 31W
Color temperature 3000K
Lighting output natural diffuser 1855lm
Lighting output grey diffuser 1800lm
Lighting output black diffuser 1545lm
Switch on/off

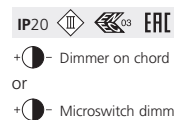

Energy Label n°1

Tolomeo Mega terra Halo

HALO max 1x150W (E27)



Energy Label n°6

HALO max 1x150W (E27)
or FLUO max 1x23W (E27)
Switch on/off

Energy Label n°4





Tolomeo terra
Tolomeo lettura
Tolomeo micro terra

design

Michele De Lucchi
Giancarlo Fassina
1987, 1990, 2001, 2010

Patent Pending
n. 11161968.0

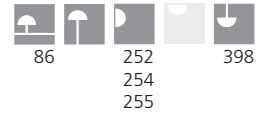

Light emission



Colours

Tolomeo terra



Tolomeo lettura

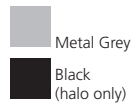

Tolomeo micro terra



Materiali: base e struttura a bracci mobili in alluminio lucidato; diffusore orientabile in tutte le direzioni in alluminio anodizzato opaco; snodi in alluminio brillantato.
Specificità: disponibile con due snodi in due dimensioni (terra e micro terra) e con uno snodo (lettura). Sistema di equilibratura a molle.

Materials: base and cantilevered arms in polished aluminium; diffuser in opaque anodized aluminium adjustable in all directions; joints in polished aluminium.

Specification: available with two joints and in two sizes (floor and micro floor versions) and with only one joint (reading-floor version). System of spring balancing.

Matériaux : base et structure à bras articulés en aluminium poli ; diffuseur, orientable dans toutes les directions, en aluminium anodisé opaque ; articulations en aluminium brillant.

Spécificité : disponible avec deux articulations en deux tailles (lampadaire et lampadaire micro) et avec une articulation (lampadaire de lecture). Système d'équilibrage à ressorts.

Materialien: Sockel und ausrichtbare Arme aus glänzendem Aluminium; in alle Richtungen verstellbarer Leuchtenkopf aus matt eloxiertem Aluminium; Gelenke aus poliertem Aluminium.

Spezifikation: Stehleuchte und Micro-Stehleuchte mit zwei Gelenken, Leseleuchte mit einem Gelenk.

Materiales: pie y estructura con brazos móviles de aluminio pulido; difusor orientable en todas direcciones en aluminio anodizado opaco; articulaciones de aluminio pulido.

Especificaciones: está disponible con dos articulaciones y en dos tamaños (terra y micro terra) y con sólo una articulación (lectura). Sistema de equilibrado a muelles.

Awards

Tolomeo terra
1989 – Compasso d'Oro / A.D.I.
Milano (Italia)

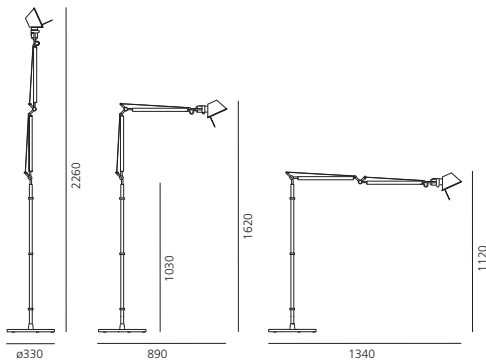

Tolomeo terra LED

LED Total power 10W
Color temperature 3000K
Lighting output 410lm



+ Microswitch dimmer

Energy Label n°1

Tolomeo terra Fluo

FLUO 1x18W (G24q-2) – TC-DEL
Lamp included
Darklight louvre included
With electronic ballast



Energy Label n°35

Tolomeo terra LED TW

LED Total power 12W
Amber, White, Blue 3000/10000K
Lighting output 550lm



+ Microswitch dimmer

Energy Label n°1

Tolomeo terra Halo

HALO max 1x77W (E27)
Lamp included



Energy Label n°29

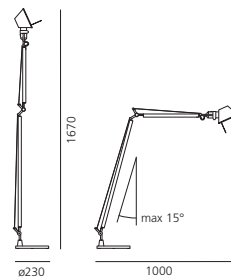

Tolomeo lettura LED

LED Total power 10W
Color temperature 3000K
Lighting output 410lm



+ Microswitch dimmer

Energy Label n°1

Tolomeo lettura Halo

HALO max 1x77W (E27)



Energy Label n°6

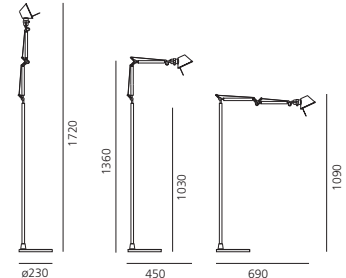

Tolomeo micro terra LED

3 Direct LED + 1 Indirect LED
Total power 8W
Color temperature 3000K
Lighting output 350lm



Energy Label n°1

Tolomeo micro terra Halo

HALO max 1x46W (E14)



Energy Label n°30



Melampo terra

Tolomeo lettura

Tolomeo micro terra

Tolomeo basculante terra
Tolomeo basculante lettura

design

Michele De Lucchi
Giancarlo Fassina
2006



Light emission



Colours

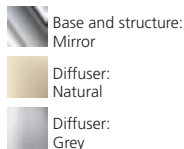

Materiali: struttura a bracci mobili in alluminio lucidato; snodi in alluminio brillantato, diffusore in carta pergamena o in raso di seta supportato da materiale plastico.

Specificità: disponibile nella versione da terra (con due snodi) o da lettura (con uno snodo). Sistema di equilibratura a molle. Il diffusore, nel normale utilizzo, si dispone verticalmente, indipendentemente dall'angolazione del braccio.

Materials: cantilevered arms in polished aluminium; joints in polished aluminium; diffuser in parchment paper or in silk satin fabric on a plastic frame.

Matériaux : structure à bras articulés en aluminium poli ; articulations en aluminium brillant ; diffuseur en papier parchemin ou en polycarbonate recouvert de satin de soie.

Materialien: Ausrichtbare Arme aus glänzendem Aluminium; Gelenke aus poliertem Aluminium; Schirm aus mit Kunststoff stabilisiertem Pergamentpapier oder Seidensatin.

Materiales: estructura con brazos móviles de aluminio pulido; articulaciones de aluminio pulido; difusor en pergamino o en raso seda reforzado con plástico.

Specification: available in floor (with two joints) or in reading-floor version (with only one joint). System of spring balancing. The diffuser normally used, remains vertical regardless of the angle of the arm.

Spécificité : disponible dans les versions lampadaire (avec deux articulations) et lampadaire de lecture (avec une articulation). Système d'équilibrage à ressorts. Le diffuseur dans le cadre d'une utilisation normale, se place verticalement, indépendamment de la position du bras.

Spezifikation: Erhältlich als Stehleuchte (mit zwei Gelenken) und als Lese-Version (mit nur einem Gelenk); mit Federausgleichsystem. Der Schirm steht normalerweise vertikal, unabhängig von der Ausrichtung des Armes.

Especificaciones: está disponible en versión de pie (con dos articulaciones) y de lectura (con sólo una articulación). Sistema de equilibrado a muelles. En su uso normal, el difusor se dispone verticalmente, independientemente del ángulo del brazo.

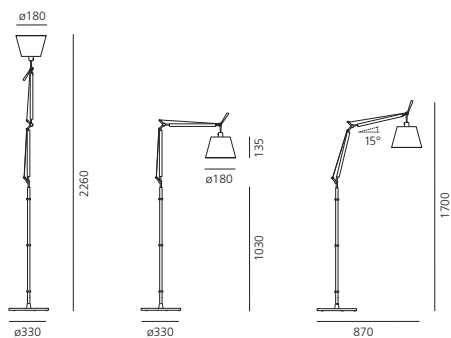

Tolomeo basculante terra

HALO max 1x100W (E27)
or FLUO max 1x20W (E27)



Energy Label n°6

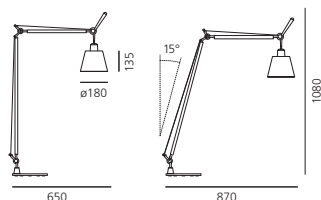

Tolomeo basculante lettura

HALO max 1x100W (E27)
or FLUO max 1x20W (E27)



Energy Label n°6



Tolomeo basculante terra



Tolomeo basculante lettura

Tolomeo XXL

design

Michele De Lucchi,
Giancarlo Fassina
2009



Light emission



Colours

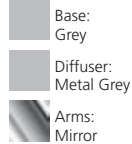

Materiali: base in cemento; struttura a bracci mobili in alluminio lucidato; testa in alluminio verniciato; diffusore in materiale termoplastico opalino satinato; snodi in alluminio brillantato.

Specificità: in scala 4:1 rispetto al modello da tavolo. Il grado di protezione IP65 la rende idonea all'utilizzo anche in esterno. Disponibile con base o supporto fisso (pivot) realizzati in cemento colorato in massa.

Materials: base in concrete; cantilevered arms in polished aluminium; head in painted aluminium; diffuser in opal thermoplastic material; joints in polished aluminium.

Matériaux : base en béton; structure à bras articulés en aluminium poli ; tête en aluminium peint ; diffuseur en matériau thermoplastique opalin ; articulations en aluminium brillant.

Materialien: Sockel aus Beton; ausrichtbare Arme aus glänzendem Aluminium; Leuchtenkopf aus lackiertem Aluminium; Schirm aus thermoplastischem Material; Gelenke aus poliertem Aluminium.

Materiales: base en cemento; estructura y brazos móviles en aluminio brillo; cabezal en aluminio pintado; difusor en material termoplástico opal satinado; nudos en aluminio brillo.

Specification: 4:1 scale compared to the table version. The IP 65 degree of protection makes it suitable for outdoor installation. Available with base or fixed support (pivot) made of solid coloured concrete.

Spécificité : a l'échelle 4:1 par rapport au modèle à poser. L'indice de protection IP 65 permet l'installation de l'appareil en extérieur. Disponible avec base ou support fixe (pivot) réalisés en béton coloré dans la masse.

Spezifikation: Im Maßstab 4:1 im Vergleich zu der Tischleuchte ist diese XXL-Version für den Innen- und Außenbereich verfügbar. Erhältlich mit Bodenplatte aus Beton oder als Bodeneinbauvariante.

Especificaciones: en escala 4:1 respecto al modelo de sobremesa. El grado de protección IP 65 la hace idónea para exteriores. Disponible con base o soporte fijo (rotatorio) realizados en cemento de color.

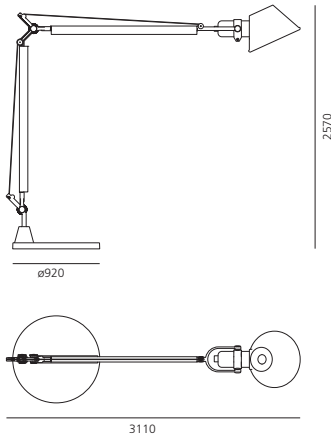

Tolomeo XXL Fluo

FLUO 2x57W (GX24q-5) – TC-TEL
Lamp included



Energy Label n°35

Tolomeo XXL HIC

METAL HALIDE 1x100W (E27) – HIC
Lamp included



Energy Label n°23



Meet Design 2011, Rome (IT) - Ph: Alessandro Rizzi



Lampade da parete

Wall lamps
Appliques
Wandleuchten
Apliques



206
Mesmeri



210
Pirce parete
Pirce micro parete



212
Talo parete



228
Copernico parete



229
Eurialo



230
Demetra faretto



246
Lunarphase



248
Talak parete



250
Flashit



264
Skopos



265
Jet
Jet base



266
Robbia



280
Miconos parete

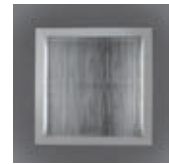

282
Altrove
parete/soffitto



284
Altrove TW
parete/soffitto

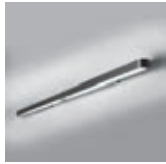

214
Talo parete
90, 120, 150, 180, 240



216
Microsurf



218
Rea



220
Cuma



222
Melete



223
Cabildo parete



224
Florensis



226
Reall parete

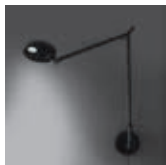

230
Demetra parete



234
Fiamma

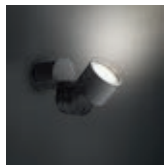

236
Objective parete



238
Cadmo parete

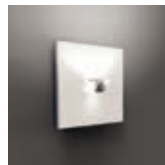

240
After dark
parete/soffitto



242
Dinarco



243
Platea



244
Nebula



252
Tolomeo parete,
mini, micro, midi,
braccio



254
Tolomeo faretto,
micro faretto

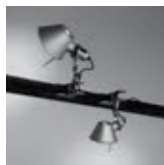

255
Tolomeo pinza,
micro pinza



256
Tolomeo basculante
parete



258
Tolomeo mega
parete



259
Tolomeo parete
diffusore



260
Melampo parete



262
Choose parete

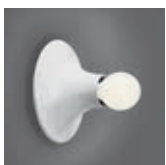

267
Teti



268
Telefo



269
Pantarei

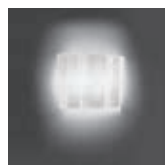

270
Logico parete,
mini, micro



270
Logico parete
3 in linea,
mini, micro



272
Empatia
parete/soffitto



274
Meteorite
parete/soffitto

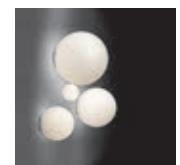

278
Dioscuri
parete/soffitto

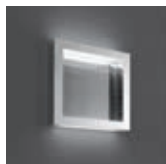

285
Altrove 600
parete/soffitto



286
Droplet mini
parete/soffitto



288
Cosmic Angel
parete



290
Cosmic Landscape
parete/soffitto

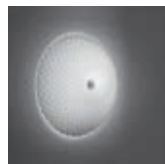

291
Cosmic Rotation
parete/soffitto



292
Edge
parete/soffitto

Lampade da soffitto

Ceiling lamps

Plafonniers

Deckenleuchten

Pláfonos

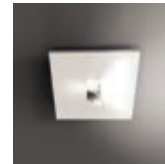

240
After dark
parete/soffitto



244
Nebula



246
Lunarphase



284
Altrove TW
parete/soffitto



285
Altrove 600
parete/soffitto



286
Droplet mini
parete/soffitto



300
Led Net Line 66/125
soffitto

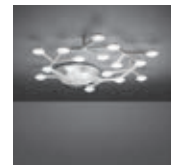

301
Led Net Circle
soffitto

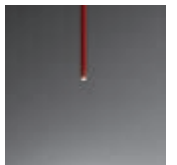

304
losif



320
Logico soffitto
mini, micro, nano



320
Logico soffitto
3 in linea,
mini, micro



320
Logico soffitto
3x120°
mini, micro



267
Teti



269
Pantarei



272
Empatia
parete/soffitto



274
Meteorite
parete/soffitto

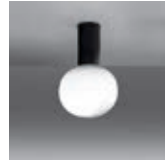

276
Laguna



278
Dioscuri
parete/soffitto



280
Miconos soffitto

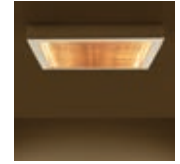

282
Altrove
parete/soffitto



289
Cosmic Angel
soffitto



290
Cosmic Landscape
parete/soffitto



291
Cosmic Rotation
parete/soffitto



292
Edge
parete/soffitto



294
Groupage



296
Float circolare
soffitto



296
Float lineare
soffitto



298
Pirce soffitto,
mini soffitto



306
Nur soffitto,
mini soffitto



308
Nur Gloss soffitto,
mini soffitto



310
Skydro

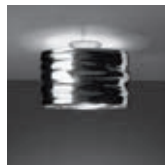

312
Aqua Cil soffitto



313
Droplet soffitto



314
Mercury soffitto,
mini soffitto



316
Cosmic Leaf soffitto

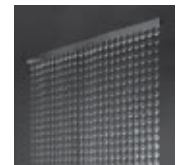

318
Botanic rain



320
Logico soffitto
4x90°
mini, micro

Mesmeri

design

Eric Solé
2005, 2012

Light emission



Colours



White



Mirror



Silver grey

Awards

2006 – iF Produkt Design Award
Hannover (Deutschland)2006 – Reddot Design Award – Product Design
Essen (Deutschland)2007 – Good Design Award
The Chicago Atheneum, Chicago (US)

Materiali: alluminio pressofuso verniciato o cromato.

Mesmeri LED: la nuova tecnologia di alimentazione LED e l'utilizzo di specifici LED progettati per essere utilizzati in circuiti non SELV consente per la prima volta di sostituire in modo trasparente per l'utente sia in termini prestazionali che di design la matura tecnologia ad alogeni con la ben più performante tecnologia LED. Il modulo LED utilizzato consente di disporre infatti di un significativo pacchetto lumen (min 2400lm), con un'appropriata temperatura di colore (3000K) ed una buona resa cromatica (CRI 80). Inoltre per il funzionamento non necessita dell'utilizzo di ingombranti dispositivi di alimentazione esteticamente invasivi. Il sofisticato sistema di alimentazione adottato riduce drasticamente effetti di flicker presenti in soluzioni analoghe basate sul raddrizzamento di alimentazioni in corrente alternata e garantisce buone efficienze ed una aspettativa di vita comparabile a quella dei LED in uso.

**Mesmeri LED**

LED Total power 28W
Color temperature 3000K
Lighting output 2130lm
Not dimmable

IP20 **ERC**

Energy Label n°1

Mesmeri Halo

HALO max 1x230W (R7s)
Lamp included
Dimmable

IP20 **ERC**

Energy Label n°5









Materials: painted or chromed die-cast aluminium.

Matériaux : aluminium moulé verni ou chromé.

Materialien: Leuchtenkörper aus lackiertem Aluminiumdruckguss oder aus mattem oder glänzendem Chrom.

Materiales: aluminio presofuso pintado o cromado.

Mesmeri LED: thanks to the new LED power supply technology and to the use of LEDs specifically designed to be used in non-SELV circuits, for the first time the traditional halogen sources can be replaced with the new and extremely performing LED technology. The LED module used in this fitting allows a significant lumen output (min. 2400 lm), with suitable colour temperature (3000K) and good chromatic output (CRI 80). Furthermore, this fitting does not require the use of bulky and aesthetically invasive power devices. Its sophisticated power supply system drastically reduces flickering effects reported in similar solutions involving the rectification of alternating current power supplies. Also it guarantees good efficiency levels and a lamp life expectancy equivalent to the LEDs in use.

Mesmeri LED : la nouvelle technologie d'alimentation à LEDs et l'emploi de LED spécifiques conçues pour être utilisées dans des circuits non SELV permet, pour la première fois, de substituer de façon transparente pour l'utilisateur, tant en termes de performances que de design, la désormais ancienne technologie des lamps halogènes avec la technologie beaucoup plus performante des LEDs. En effet, le module à LEDs utilisé permet de disposer d'une quantité significative de lumen (2400 lm mini), avec une température de couleur appropriée (3000K) et un bon rendu chromatique (CRI 80). En outre, son fonctionnement ne réclame pas l'emploi de dispositifs d'alimentation encombrants et invasifs esthétiquement parlant. Le très sophistiqué système d'alimentation adopté réduit radicalement les effets de clignotement présents dans des solutions analogues basées sur le redressement d'alimentation en courant alternatif. Il garantit une bonne efficacité et un cycle de vie comparable à celui des LED actuelles.

Mesmeri LED: Die neue LED-Versorgungstechnik und die Verwendung spezifischer LED, die für den Einsatz außerhalb des SELV-Bereiches entwickelt wurden, ermöglichen es dem Benutzer zum ersten Mal, die bewährte Halogentechnologie sowohl hinsichtlich Leistung als auch Design auf transparente Weise durch die wesentlich leistungsstärkere LED-Technologie zu ersetzen. Das verwendete LED-Modul gewährleistet eine signifikante Lumenzahl (mindestens 2400 lm) bei einer Farbtemperatur von 3000 K und guter Farbwiedergabe (CRI 80). Außerdem erfordert diese LED keine unschönen und platzraubenden Netzgeräte. Das ausgeklügelte Versorgungssystem reduziert die Flacker-Effekte ähnlicher Lösungen, garantiert eine effiziente Leistung und eine mit herkömmlichen LEDs vergleichbare Lebenserwartung.

Mesmeri LED: gracias a la nueva tecnología de alimentación LED y al uso de LED específicos, que se diseñaron expresamente para su uso en circuitos no SELV, por vez primera, es posible sustituir la madura tecnología de los halógenos por la tecnología LED, de prestaciones muy superiores. Al efecto, además, se puede proceder de manera transparente para con el usuario tanto por lo que se refiere a las prestaciones como al diseño. El módulo LED empleado, efectivamente, permite disponer de un paquete de lúmenes notable (mín: 2400 lm), con una temperatura del color adecuada (3.000 K) y un buen rendimiento cromático (IRC 80). Como si ello fuera poco, para funcionar no requiere dispositivos de alimentación de gran tamaño, que tanto merman la estética. El sofisticado sistema de alimentación aplicado reduce contundentemente los efectos de parpadeo o flicker, que se hallan en soluciones análogas, basadas en la rectificación de la alimentación eléctrica con corriente alterna. El mismo garantiza un buen nivel de eficiencia y unas expectativas de vida útil equivalentes a las de los LED instalados.

Pirce parete
Pirce micro parete

Design

Giuseppe Maurizio Scutellà
2010



Light emission



Colour

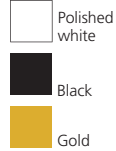

Materiali: alluminio verniciato.

Materials: painted aluminium.

Matériaux : aluminium peint.

Materialien: Lackiertes Aluminium.

Materiales: aluminio pintado.

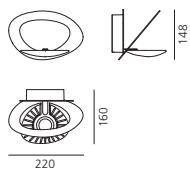

Pirce micro parete LED

LED Total power 29W
Color temperature 3000K
Lighting output 2249lm
Dimmable 1-10V

IP20

Energy Label n°1

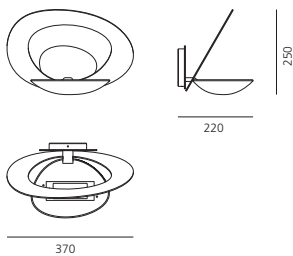

Pirce parete

HALO max 1x230W (R7s)
Lamp included
Dimmable

IP20

Energy Label n°5





Talo parete

design

Neil Poulton
2002, 2012

Light emission



Colours

**Materiali:** alluminio pressofuso verniciato o cromato.**Materials:** die-cast aluminium painted or chromed.**Matériaux :** aluminium galvanisé verni ou chromé.**Materialien:** Lackierter oder verchromter Aluminiumdruckguss.**Materiales:** aluminio comprimido pintado o cromado.

Awards

2002 – Prix “L’Observateur du Design 2002”
“Etoile 2002” – Paris (France)2002 – Reddot Design Award
Essen (Deutschland)2002 – iF Product Design Award
Hannover (Deutschland)2002 – Compasso d’Oro / ADI – Selezione
Milano (Italia)**Talo parete LED**LED Total power 20W
Color temperature 3000K
Lighting output 1225lm
Not dimmable

IP20

Energy Label n°1

**Talo parete fluo**FLUO 1x18W (G24q-2) – TC-DEL
With electronic ballast
Not dimmable

IP20

Energy Label n°7

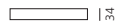
**Talo parete Halo**HALO max 1x120W (R7s)
Lamp included
Dimmable

IP20

Energy Label n°29







Talo 90 parete
Talo 120 parete
Talo 150 parete
Talo 180 parete
Talo 240 parete

design

Neil Poulton
2001, 2002

Light emission



Colours



White

Silver grey

Materiali: corpo in alluminio verniciato; testate di chiusura in alluminio pressofuso.

Specificità: disponibile in tre lunghezze a seconda della potenza della sorgente luminosa: 90,5 cm (39W), 120,5 cm (54W), 150,5 cm (80W). Talo parete da 39W e 54W è disponibile in versione bilampada in due lunghezze: 179,5 cm e 239,5 cm.

Awards

2002 – Prix “L’Observateur du Design 2002”
“Etoile 2002” – Paris (France)

2002 – Reddot Design Award
Essen (Deutschland)

2002 – iF Product Design Award
Hannover (Deutschland)

2002 – Compasso d’Oro / ADI – Selezione
Milano (Italia)

Materials: body in painted aluminium; die-cast aluminium endpieces.

Specification: available in three lengths depending by the voltage of the light source: 90,5 cm (39W), 120,5 cm (54W), 150,5 cm (80W). 39W and 54W versions are available also with twin light sources and in two lengths: 179,5 and 239,5 cm.

Matériaux : corps en aluminium verni; embouts de finition en aluminium galvanisé.

Spécificité : disponible en trois longueurs selon la puissance de la source lumineuse: 90,5 cm (39W); 120,5 cm (54W); 150,5 cm (80W). Talo parete 39W et 54W sont disponibles en version bitube en deux longueurs : 179,5 cm, 239,5 cm.

Materialien: Körper aus lackiertem Aluminium; Wandhalterung aus Aluminiumdruckguss.

Spezifikation: Erhältlich in drei Größen mit unterschiedlicher Bestückung: 90,5cm (39W), 120,5cm (54W), 150,5cm (80W). Die 39W und 54W Versionen sind auch in 2-lampiger Ausführung und in zwei Längen: 179,5 cm; 239,5 cm erhältlich.

Materiales: cuerpo de aluminio pintado; cabezales de cierre de aluminio comprimido.

Especificaciones: disponible en tres longitudes, según la potencia de la fuente luminosa: 90,5cm (39W), 120,5cm (54W), 150,5cm (80W). Talo parete 39W y 54W disponible en versión bitubo en dos longitudes: 179,5cm, 239,5cm.

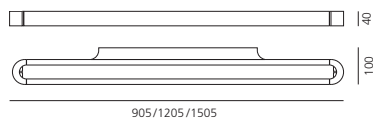

Talo 90 parete LED

LED Total power 33W
Color temperature 3000K
Lighting output 3175lm
Not dimmable or dimmable



Energy Label n°1

Talo 120 parete LED

LED Total power 52W
Color temperature 3000K
Lighting output 4648lm
Not dimmable or dimmable



Energy Label n°1

Talo 150 parete LED

LED Total power 65W
Color temperature 3000K
Lighting output 5869lm
Not dimmable or dimmable



Energy Label n°1

Talo 90 parete Fluo

FLUO 1x39W (G5)
Lamp included
With electronic ballast
Not dimmable



Energy Label n°23

Talo 120 parete Fluo

FLUO 1x54W (G5)
Lamp included
With electronic ballast
Not dimmable



Energy Label n°23

Talo 150 parete Fluo

FLUO 1x80W (G5)
Lamp included
With electronic ballast
Not dimmable



Energy Label n°23

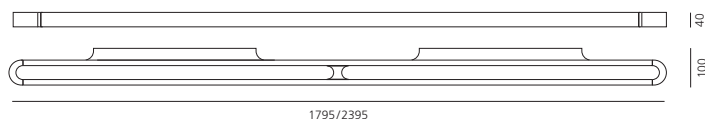

Talo 180 parete Fluo

FLUO 2x39W (G5)
Lamp included
With electronic ballast
Not dimmable



Energy Label n°23

Talo 240 parete Fluo

FLUO 2x54W (G5)
Lamp included
With electronic ballast
Not dimmable



Energy Label n°23



Custom project, Schlossl, Oberrotterbach (Germany)
Ph: Werner Huthmacher



Microsurf

design

Neil Poulton
2013, 2014

Light emission



Colours



White



Bronze



Gold

Un segno minimalista quasi impercettibile che si integra in qualunque contesto architettonico.

Materiali: alluminio pressofuso verniciato.

A minimal, almost unobtrusive design to be integrated into any architectural setting.

Materials: die-cast painted aluminium.

Microsurf est un signe minimaliste presque imperceptible qui s'intègre dans n'importe quel contexte architectural.

Matériaux : aluminium galvanisé verni.

Minimalistisch, fast unmerklich: diese Leuchte integriert sich in fast jedes architektonische Umfeld.

Materialien: Lackiertes Aluminiumdruckguss.

Un signo minimalista casi imperceptible capaz de integrarse en cualquier contexto arquitectónico.

Materiales: aluminio comprimido pintado.

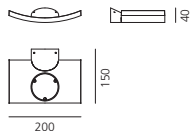

LED Total power 26W
Color temperature 3000K
Lighting output 2124lm
Not dimmable

IP20   EAC

Energy Label n°1

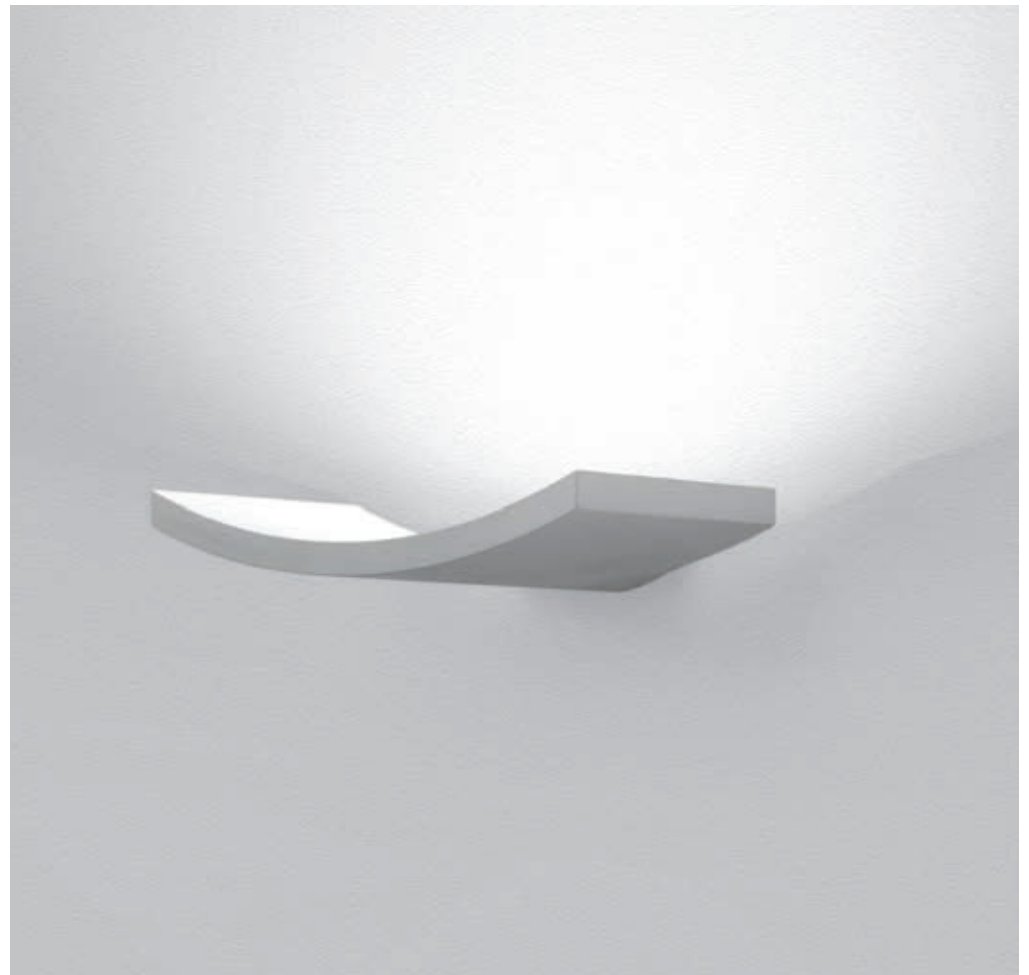



Rea 12
Rea 17

design

Neil Poulton
2013, 2014



Light emission



Colours



White

Materiali: alluminio pressofuso verniciato.

Specificità: due dischi equivalenti e perpendicolari assolvono la funzione di supporto alla parete e alloggiamento dell'ottica a LED, che emette una luce diffusa indiretta.

Awards

2014 – Reddot Design Award
High Design Quality
Essen (Deutschland)

Materials: die-cast painted aluminium.

Specifications: two orthogonal discs of the same dimensions are employed, one as a wall bracket and the other as an LED optical unit, emitting indirect, diffused light.

Matériaux : aluminium galvanisé verni.

Spécificités : deux disques équivalents et perpendiculaires qui assument la fonction de support mural et de logement de l'optique LED qui émet une lumière diffuse indirecte.

Materialien: Lackiertes Aluminiumdruckguss.

Spezifikation: Die Wandleuchte besteht aus zwei gleichen Scheiben aus lackiertem Aluminium, von denen die eine als Wandhalterung dient. Die andere beherbergt das LED Leuchtmittel, das ein indirektes, diffuses Licht abgibt.

Materiales: aluminio comprimido pintado.

Especificaciones: dos discos equivalentes y perpendiculares funcionan como un soporte de pared y alojan la unidad óptica de LED, que emite luz difusa indirecta.

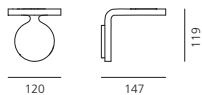

Rea 12

LED Total power 13W
Color temperature 3000K
Lighting output 800lm
Not dimmable

IP20

Energy Label n°1

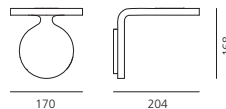

Rea 17

LED Total power 26W
Color temperature 3000K
Lighting output 2137lm
Not dimmable

IP20

Energy Label n°1

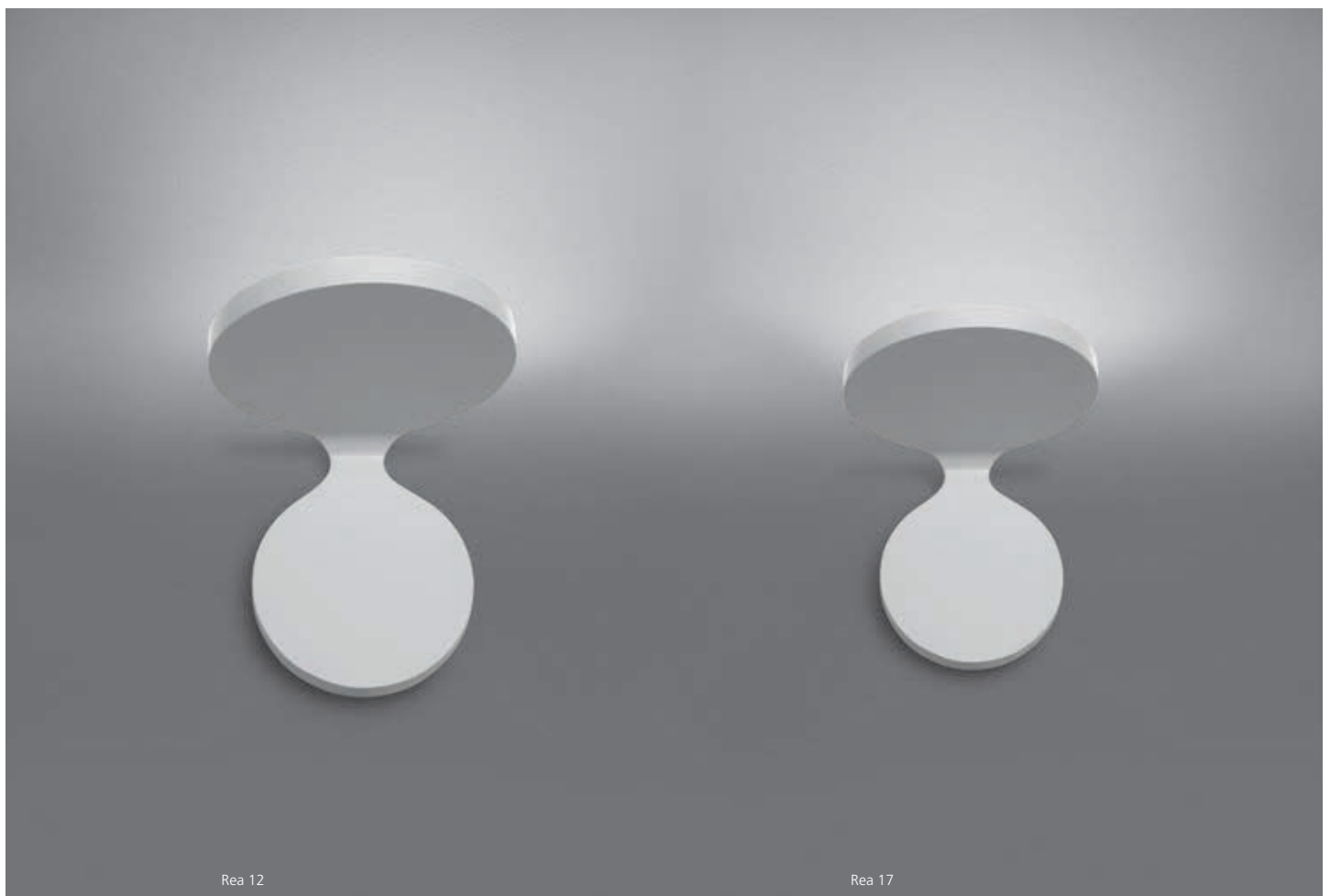

Rea 12

Rea 17



Cuma 10
Cuma 20
Cuma 26

design

Roberto Paoli
2011, 2012



Light emission



Colour



Polished
white

Materiali: alluminio pressofuso verniciato.

Specificità: disponibile in versione alogena (Cuma 26) e a LED (Cuma 10 e Cuma 20).

Materials: die-cast painted aluminium.

Specification: available in two versions: halogen (Cuma 26) and LED (Cuma 10 and Cuma 20).

Matériaux : aluminium moulé et peint.

Spécificité : disponible en version halogène (Cuma 26) et en version LED (Cuma 10 et Cuma 20).

Materialien: Lackiertes Aluminiumdruckguss.

Spezifikation: Erhältlich für Halogenlampen (Cuma 26) sowie als LED-Versionen (Cuma 10 und Cuma 20).

Materiales: aluminio fundido a presión.

Especificaciones: está disponible en la versión halógena (Cuma 26) y en la versión LED (Cuma 10 y Cuma 20).

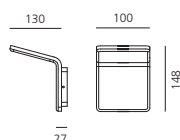

Cuma 10

LED Total power 14W
Color temperature 3000K
Lighting output 696lm
Not dimmable



Energy Label n°1

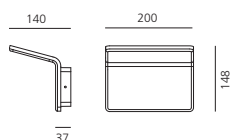

Cuma 20

LED Total power 28W
Color temperature 3000K
Lighting output 1431lm
Not dimmable



Energy Label n°1

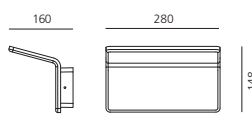

Cuma 26

HALO max 1x230W (R7s)
Lamp included
Dimmable



Energy Label n°5



Cuma 10

Cuma 20



Melete

design

Pio & Tito Toso
2011

Light emission



Colour

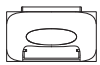
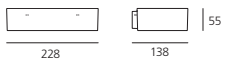

White

Materiali: alluminio pressofuso verniciato.**Awards**2012 – Reddot Design Award
High Design Quality
Essen (Deutschland)**Materials:** die-cast painted
aluminium.**Matériaux :** aluminium
moulé et peint.**Materialien:** Lackierter
Aluminiumdruckguss.**Materiales:** aluminio
fundido a presión, pintado.**Melete LED**LED Total power 29W
Color temperature 3000K
Lighting output 2130lm
DimmableIP20  ENEC

Energy Label n°1

Melete HaloHALO max 1x160W (R7s)
Lamp included
DimmableIP20   ENEC

Energy Label n°5



Light emission



Colour



White

Materiali: attacco parete e corpo lampada in alluminio pressofuso verniciato.

Materials: wall support and body lamp in painted die-cast aluminium.

Matériaux : support applique et corps en aluminium moulé sous pression peint.

Materialien: Wandhalterung und Leuchtenkörper aus druckgegossenem, lackiertem Aluminium.

Materiales: soporte a pared y cuerpo de la lámpara en aluminio fundido a presión y pintado.

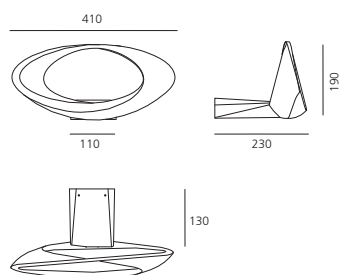

HALO max 1x230W (R7s)
Lamp included
Dimmable



Energy Label n°5



Florensis parete

design

Ross Lovegrove
2013

Light emission



Colours



Aluminium grey



Black

Materiali: supporto parete in alluminio verniciato; testa in alluminio anodizzato e verniciato.

Materials: wall support in painted aluminium; head in anodized and painted aluminium.

Matériaux : support mural en aluminium verni ; tête en aluminium anodisé verni.

Materialien: wandhalterung aus lackiertem Aluminium-druckguss; Leuchtenkopf aus lackiertem Aluminium.

Materiales: soporte pared en aluminio pintado; cabezal en aluminio anodizado y pintado.

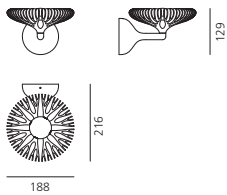

LED Total power 28W
Color temperature 3000K
Lighting output 1838lm
Not dimmable



Energy Label n°1





Reall parete

design

Carlotta de Bevilacqua
Paolo Dell'Elce
2011



Light emission



Colour



Materiali: pressofusione di alluminio con finitura brillantata lucida o verniciata.

Specificità: un'unica sorgente LED di ultima generazione garantisce gli stessi valori di illuminamento ottenibili con una 400W alogena. Leggerezza visiva e termodinamica sono le caratteristiche principali di questo progetto: la testa pressofusa è opportunamente sagomata e traforata per rappresentare un'interfaccia visiva permeabile nello spazio in cui si colloca e agevolare lo scambio termico della sorgente, garantendone una dissipazione ottimale del calore.

Materials: die-cast aluminium painted or chromed.

Matériaux : aluminium galvanisé verni ou chromé.

Materialien : Lackierter oder verchromter Aluminiumdruckguss.

Materiales : aluminio comprimido pintado o cromado.

Specification: a next-generation LED source with the same illuminance values of a 400W halogen source. The concepts inspiring this project are visual lightness and thermodynamics: the lamphead, made of die-cast aluminium, is suitably shaped and punctured to create a partially see-through visual interface, enabling heat transfer while ensuring optimal heat dissipation.

Spécificité : une seule source à LEDs de dernière génération fournit les mêmes valeurs d'éclairage que l'on peut obtenir avec une lampe halogène de 400W. La légèreté visuelle et la thermodynamique sont les principales caractéristiques de ce projet. La tête, réalisée en aluminium moulé sous pression, est judicieusement profilée et ajourée pour constituer une interface visuelle et perméable de l'espace dans lequel elle se situe et facilite l'échange thermique, en garantissant une dissipation optimale de la chaleur produite par la source.

Spezifikation: Die Leuchten verfügen über eine einzige LED, welche die gleichen Leistungen einer 400W-Halogenleuchte erzielt. Die Leuchte besticht durch den Eindruck von Schwerelosigkeit sowie durch eine ausgeklügelte Thermodynamik. Das Kopfstück aus spezialgeformtem und gelochtem Aluminiumdruckguss schafft eine unterbrechungsfreie visuelle Verbindung mit dem Raum und begünstigt den Wärmeaustausch, so dass eine optimale Wärmeableitung erzielt wird.

Especificaciones: una única fuente LED de última generación garantiza los mismos valores de iluminación que se obtienen con una halógena de 400W. Ligereza visual y termodinámica son las características principales de este proyecto: la cabeza, realizada en aluminio moldeado bajo presión, está oportunamente perfilada y perforada para presentar una interfaz visual permeable del espacio en que se coloca y facilitar el intercambio térmico, garantizando una óptima disipación del calor producido por la fuente.

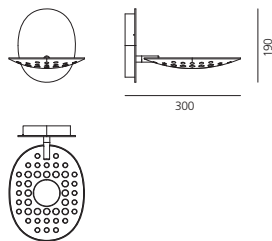

LED Total power 45W
Color temperature 3000K
Lighting output 2631lm
Dimmable



Energy Label n°1





Copernico parete

Design

Carlotta de Bevilacqua
Paolo Dell'Elce
2010

Patent Pending
n. MI2010A000610



338
340

Light emission



Colours



Metal Grey



Metal Black

Materiali: alluminio anodizzato.

Specificità: tre elementi concentrici ricavati da un'unica lastra di alluminio supportano un circuito di 400 LED bianchi. I due elementi interni ruotano indipendentemente sull'asse orizzontale, permettendo di orientare l'emissione luminosa e contemporaneamente di ottenere diverse configurazioni.

Materials: anodised aluminium.

Specification: a circuit of 400 white LEDs is installed into three concentric elements created from a single aluminium plate. The two internal elements rotate independently on the horizontal axis, enabling the adjustment of the light emission and the creation of multiple spatial configurations.

Matériaux : aluminium anodisé.

Spécificité : trois éléments concentriques obtenus à partir d'une seule plaque en aluminium supportent un circuit de 400 LED blanches. Les deux éléments intérieurs tournent indépendamment sur l'axe horizontal, ce qui permet à la fois d'orienter l'émission de lumière et d'obtenir de nombreuses configurations.

Material: Eloxiertes Aluminium.

Spezifikation: Drei konzentrische, aus einer einzigen Aluplatte realisierte Elemente, auf denen eine Leiterplatte mit 400 weißen LED angebracht ist. Die beiden inneren Elemente drehen sich voneinander unabhängig um die horizontale Achse, so dass eine individuelle Ausrichtung des Lichtstrahls erzielt wird und immer wieder neue Konfigurationen im Raum entstehen.

Materiales: aluminio anodizado.

Especificaciones: tres elementos concéntricos, realizados a partir de una única placa de aluminio, hacen de base a un circuito de 400 LEDs blancos. Los dos elementos interiores giran independientemente a lo largo del eje horizontal. Merced a ello, es posible orientar el haz de luz y obtener distintas configuraciones al mismo tiempo.

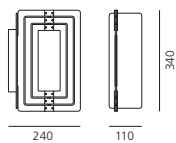

LED Total power 30W
Color temperature 3000K
Lighting output 1672lm
Dimmable



Energy Label n°1





Light emission



Colours



Metal grey



Polished White



Polished Black/White

Materiali: lamiera di alluminio stampato, verniciato o spazzolato.

Materials: moulded aluminium plate, painted or brushed.

Matériaux : tôle en aluminium moulé, peint ou brossé.

Materialien: Gegossenes Aluminiumblech, lackiert oder gebürstet.

Materiales: chapa de aluminio prensado, pintado o cepillado.



Eurialo Fluo

FLUO 1x32W (GX24q-3) – TC-TEL
or FLUO 1x42W (GX24q-4) – TC-TEL
Not dimmable

IP20 **ERC**

Energy Label n°7

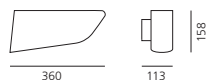

Eurialo Halo

HALO max 1x160W (R7s)
Lamp included
Dimmable

IP20 **ERC**

Energy Label n°5



Demetra faretto
Demetra parete

design

Naoto Fukasawa
2013



Light emission



Colours



Materiali: attacco parete e testa in pressofusione di alluminio con finitura verniciata; bracci in estruso di alluminio.

Materials: wall support, head and arms in painted die-cast aluminium; arms in extruded aluminium

Matériaux : fixation murale et tête en aluminium moulé sous pression peint; bras en aluminium extrudé

Materialien: Wandhalterung und Leuchtenkopf aus lackiertem lackiertem Aluminium; Arme aus fließgepresstem Aluminium.

Materiales: soporte pared y cabezal en aluminio comprimido pintado, brazos en aluminio extruido.

Awards

2014 - Design plus
Light+Building Award
Frankfurt (Deutschland)

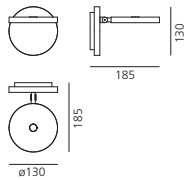

Demetra faretto

LED Total power 10W
Color temperature 3000K
Lighting output 392lm
With or without switch

IP20 **EAC**

+ - Microswitch dimmer

Energy Label n°1





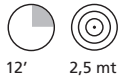

Dimmer on top



Movement detector

Demetra parete MD: in questa versione è presente un sensore Movement Detector, che gestisce l'accensione dell'apparecchio a seconda della vicinanza dell'utente.

Demetra parete MD: this table model features a Motion Detector option detecting moving objects and people and turning the light on or off accordingly.

Demetra parete MD : cette version est dotée d'un détecteur de mouvement qui gère l'allumage de l'appareil selon la présence ou non de l'utilisateur.

Demetra parete MD: Diese Version der Tischleuchte ist mit einem Bewegungsmelder ausgestattet.

Demetra parete MD: en esta versión existe un sensor de Detección de Movimiento; que gestiona el encendido del aparato según la proximidad del individuo.

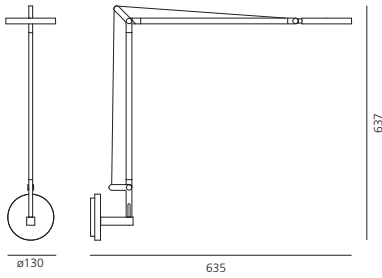

Demetra parete/MD

LED Total power 9,5W
Color temperature 3000K
Lighting output 392lm



+ Microswitch dimmer

Energy Label n°1



Anthracite grey



White



Titanium

Fiamma parete

design

Jean-Michel Wilmotte
2014

Light emission



Colour

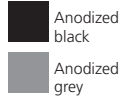

Materiali: corpo della lampada in alluminio estruso, modellato meccanicamente; diffusore in policarbonato trasparente stampato ad iniezione; attacco alla parete in tecnopolimero verniciato.

Materials: lamp body in extruded aluminum, mechanically moulded; transparent injection-moulded polycarbonate diffuser; wall support in technopolymer.

Matériaux : corps en aluminium extrudé usiné; diffuseur en polycarbonate transparent moulé par injection; fixation murale en techno-polymère

Materialien: leuchtenkörper besteht aus fließgepresstem Aluminium; Der transparente Schirm aus Polycarbonat ist spritzgegossen; Wandhalterung und Leuchtenkopf aus Technopolymer.

Materiales: cuerpo de la lámpara en aluminio extruido, modelado mecánicamente para obtener el efecto de textura que recuerda las formas de una llama; el difusor en policarbonato transparente moldeado por inyección.

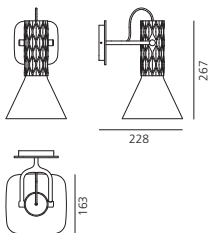

LED max 8W (E14)

Dimmable

IP20 EAC

Energy Label n°9





Objective parete

design

Jean Nouvel
2013

Light emission



Colour

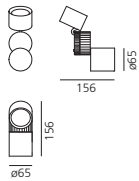

Black

Materiali: corpo lampada in alluminio verniciato.**Materials:** lamp body
in painted aluminium.**Matériaux :** corps
en aluminium verni.**Materialien:**
Leuchtenkörper aus
lackiertem Aluminium.**Materiales:** cuerpo lámpara
en aluminio pintado.**Awards**2015 – iF Product Design Award
Deutschland2014 – Design Plus Light+Building Award
Frankfurt (Deutschland)LED Total power 5W
Color temperature 3000K
Lighting output 270lm
Not dimmableIP20  

Energy Label n°1





Cadmoparete

design

Karim Rashid
2009

Light emission



Colours

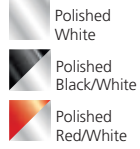

Materiali: corpo lampada in materiale termoplastico stampato a iniezione; riflettore in alluminio ottico.

Materials: body lamp in injection-moulded thermoplastic material; reflector in optic aluminium.

Matériaux : corps en matériau thermoplastique moulé par injection ; réflecteur en aluminium à haut rendement.

Materialien: Reflektierender Leuchtenkörper aus Spritzguss-Thermoplast; Reflektor in Aluminium-Optik.

Materiales: cuerpo de la lámpara en material termoplástico estampado a inyección; reflector en aluminio óptico.

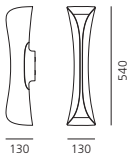

Cadmoparete LED

2 LED max 10W (GU10)
Lamp included



Energy Label n°36

Cadmoparete Fluo

FLUO 2x26/32W (GX24q-3) – TC-TEL
Not dimmable



Energy Label n°7



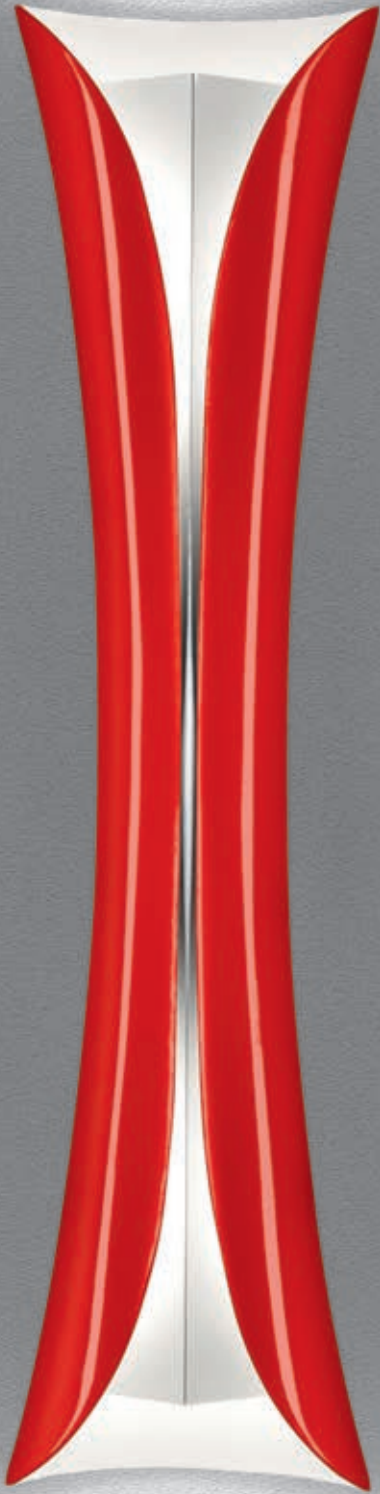

After dark parete/soffitto

design

Carlotta de Bevilacqua
2014



Light emission



Colour



After Dark nasce da un approfondito studio della fisica della luce e dei suoi comportamenti: la conduzione della luce è il principio base per la genesi del prodotto, la riflessione e la rifrazione il mezzo, la diffusione di essa nello spazio il punto di arrivo.

Materiali: corpo della lampada in pressofusione di alluminio verniciato; guida luce in metacrilato a basso coefficiente di assorbimento
Specificità: la particolare lavorazione del pipe e la sua finitura nella versione a parete consentono di riflettere la luce e dare vita a un'efficace emissione uplight. Nella versione a soffitto la luce viene invece diretta in modo controllato attraverso una micro griglia appositamente progettata dopo essere stata condotta all'interno del pipe, e riempie lo spazio senza offendere la vista.

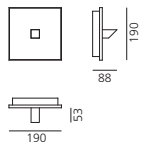

After dark parete

LED Total power 29W
Color temperature 3000K
Lighting output 2100lm
Dimmable



Energy Label n°1

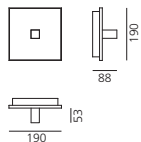

After dark soffitto

LED Total power 29W
Color temperature 3000K
Lighting output 2100lm
Dimmable



Energy Label n°1

After Dark is the result of in-depth research on the physics and behaviours of light: light conduction is the basic principle for the product's creation, reflection and refraction are the means, light diffusion in space is the final destination.

Materials: body in die-cast aluminium painted; low absorption coefficient methacrylate light guide.

Specification: the special construction and finish of the pipe in the wall version allows light reflection and the achievement of effective uplight emission. In the ceiling version, light is instead direct in a controlled way through a micro-grid that was specially designed after being conducted inside of the pipe, pervading space without impairing vision.

After Dark est le résultat d'une recherche approfondie sur la physique et les comportements de la lumière : la conduction de la lumière est le principe de base pour la création, la réflexion et la réfraction du produit sont les moyens, la diffusion de la lumière dans l'espace est la destination finale.

Matériaux : corps en aluminium galvanisé verni; guide lumière en méthacrylate à faible coefficient d'absorption.

Spécificités : la construction particulière et la finition de la tige dans la version applique permettent la réflexion de la lumière et une restitution efficace de l'éclairage indirect. Dans la version plafonnier, la lumière directe contrôlée grâce à une micro grille spécialement conçue occupe l'espace sans nuire à la vision.

After Dark ist aus einer umfassenden Studie über die Physik und das Verhalten von Licht entstanden: Das Grundprinzip des Produkts ist die Führung des Lichts, das mittels Reflexion und Brechung in den Raum gestreut wird.

Materialien: Leuchtenkörper aus lackiertem Aluminiumdruckguss; Lichtleiter aus Methacrylat mit niedrigem Absorptionskoeffizienten.

Spezifikation: Die besondere Ausführung des Leiters in der Wandleuchte reflektiert das Licht und schafft eine effektive Lichtverteilung ähnlich einem Deckenfluter. Bei der Deckenversion hingegen wird das Licht, nachdem es im Inneren des Gehäuses gebrochen wird, kontrolliert durch ein spezielles Mikronetz gesteuert und blendfrei in den Raum gestreut.

After Dark nace de una profundización en el estudio de la física de luz y de sus comportamientos: la conducción de la luz es el principio base para la génesis del producto, la reflexión y la refracción son los medios, la difusión de la luz en el espacio es el destino final.

Materiales: cuerpo en aluminio comprimido pintado; guía de la luz en metacrilato con bajo coeficiente de absorción.

Especificaciones: la particular elaboración de la "tija" y su acabado en la versión a pared permiten reflejar la luz y dar vida a una eficiente emisión uplight. En la versión a techo la luz se dirige de manera directa a través de una micro-rejilla diseñada especialmente después de haber sido controlada en el interior de la "tija", que impregna todo el espacio sin perjudicar la visión.

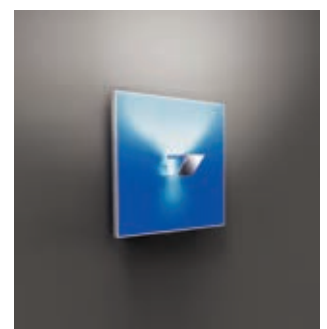
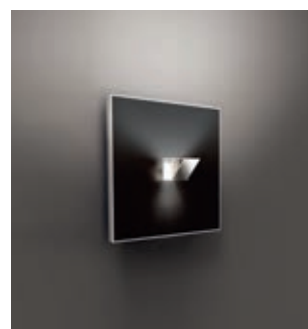
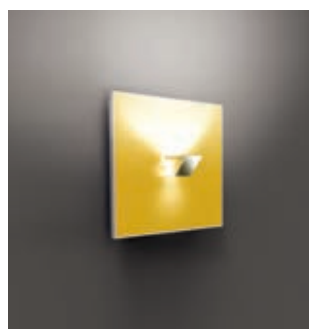



Dinarco

design

Carlo Forcolini
Giancarlo Fassina
2011



Light emission



Colour



White

Materiali: corpo in metallo verniciato; supporto parete in alluminio pressofuso.

Materials: painted metal body; die-cast aluminium wall support.

Matériaux : corps en métal verni ; support applique en aluminium moulé.

Materialien: Gehäuse aus lackiertem Metall; Wandhalterung aus Aluminiumdruckguss.

Materiales: cuerpo en metal pintado; soporte de applique de aluminio fundido a presión.

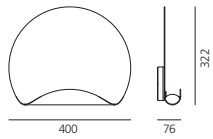

HALO max 1x160W (R7s)
Lamp included
Dimmable



Energy Label n°5





Light emission



Colour



Polished
White

Materiali: corpo lampada/riflettore in metacrilato verniciato; diffusore posteriore in metacrilato opalino.

Specificità: la luce si diffonde sia dal taglio sulla superficie anteriore della lampada, sia dal diffusore posto nella parte posteriore.

Materials: painted methacrylate lamp unit/reflector; opal methacrylate rear diffuser.

Matériaux : corps réflecteur en méthacrylate peint ; diffuseur arrière en méthacrylate opalin.

Materialien: Leuchtenkörper/ Reflektor aus lackiertem Methacrylat; rückseitiger Diffusor aus opalinem Methacrylat.

Materiales: cuerpo de la lámpara/reflector de metacrilato pintado. Difusor trasero de metacrilato opalino.

Specification: the light is diffused both through the cut at the front of the fitting, and from the diffuser located at its back.

Spécificité : la lumière se diffuse aussi bien à partir de l'entaille faite sur la surface avant de la lampe, que depuis le diffuseur situé dans la partie arrière.

Spezifikation: Der Lichtaustritt erfolgt durch einen Einschnitt im vorderen Teil der Leuchte sowie durch einen an der Rückseite Teil befestigten Diffusor.

Especificaciones: la luz se propaga a través del corte que se aprecia en la superficie delantera de la lámpara y por el difusor que está situado en la parte trasera.

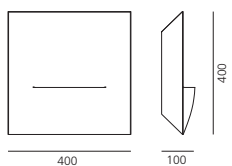

FLUO 1x42W (GX24q-4) – TC-TEL
Lamp included
Not dimmable



Energy Label n°35



Nebula

design

Ross Lovegrove
2012

Light emission



Colour

Structure:
Polished whiteDiffuser:
WhiteDiffuser:
Gold

“I vortici generati da uno script parametrico avanzato sono forme che catturano la luce, creando un fenomeno di emissione di luce grazie a un anello di LED disposti lungo la circonferenza. Può essere montato in gruppi singoli o multipli su pareti o soffitti”.

Materiali: struttura in alluminio verniciato. Diffusore in materiale termoplastico.

“Light trapping vortices created through advanced parametric scripting are able to also radiate light thanks to a halo of LEDs fitted in the inner perimeter. It can be installed in single or multiple configurations, wall- or ceiling-mounted”.

« Les tourbillons générés par un script paramétrique avancé sont des formes qui saisissent la lumière, en créant un phénomène d’émission de lumière grâce à un anneau de LED disposés sur la circonférence. Peut être monté en groupes simples ou multiples au mur ou au plafond ».

„Die aus Parametersätzen generierten Wirbel fangen das Licht ein, das von dem LED Ring am Rand der Leuchte abgegeben wird und erzeugen eine außergewöhnliche Lichtatmosphäre. Die Leuchte kann einzeln oder in Gruppen an der Wand oder Decke installiert werden“.

“Una leyenda paramétrica puntera genera vórtices que se convierten en formas destinadas a atrapar la luz. Así, se crea un fenómeno de emisión de luz, gracias a un anillo de LEDs que están ubicados a lo largo de la circunferencia. Se pueden montar en un solo grupo o en grupos múltiples, tanto en la pared como en el techo”.

Materials: structure in painted aluminium; diffuser in thermoplastic material.

Matériaux : structure en aluminium verni, diffuseur en matériau thermoplastique.

Materialien: Struktur aus lackiertem Aluminium. Diffusor aus thermoplastischem Material.

Materiales: estructura de aluminio pintado; difusor de material termoplástico.

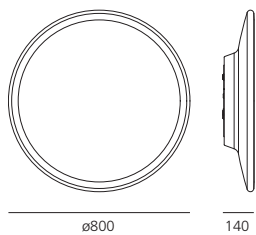

48 strip x 12 LED
Total power 47W
Color temperature 3000K
Lighting output 2087lm
Not dimmable

IP20      

Energy Label n°1





Lunarphase 450
Lunarphase 600

design

Carlotta de Bevilacqua
2012



Light emission



Colours

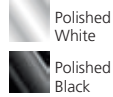

Materiali: alluminio tornito in lastra.

Specificità: una forma apparentemente organica nasconde un principio ottico innovativo che, attraverso un'emissione laterale e suggestiva garantisce una performance luminosa competitiva e una significativa riduzione dell'impegno energetico. Una fluorescente circolare diffonde la luce a 360° nell'ambiente grazie a un'ottica in alluminio di soli 45mm di altezza: il flusso luminoso viene raccolto completamente e indirizzato verso lo spazio in modo indiretto senza offendere lo sguardo.

Materials: lathed aluminium plate.

Matériaux : plaque d'aluminium tournée.

Materialien: Gedrehte Aluminiumplatte.

Materiales: placa de aluminio torneada.

Specification: an apparently organic form conceals an innovative optical unit using a distinctive side emission to ensure good lighting performance and significantly reduced power consumption. A circular fluorescent source diffuses the light into the environment over 360° thanks to the 45mm aluminium optics: the light flow is collected in full and directed laterally towards the space without impairing vision.

Spécificité : cette forme apparemment organique cache un principe optique novateur qui, par une émission latérale et suggestive, garantit une performance lumineuse compétitive et une réduction significative de l'engagement énergétique. Une source fluorescente circulaire diffuse la lumière à 360° dans l'espace grâce à une optique de seulement 45 mm de hauteur : le flux lumineux est complètement recueilli et dirigé vers l'espace, latéralement, sans gêner la vision.

Spezifikation: Eine scheinbar organische Form verbirgt ein innovatives Optik-Prinzip, das durch seitliche Lichtverteilung eine angenehme Lichtatmosphäre kreiert und sich durch starke Leistung bei signifikanter Senkung des Energieverbrauchs auszeichnet. Eine kreisförmige Leuchtstoffröhre verteilt das Licht mittels einer nur 45 mm hohen Optik auf 360° im Raum: Der Lichtstrom wird gebündelt und seitlich in den Raum gestrahlt, ohne den Blick zu stören.

Especificaciones: una forma aparentemente orgánica esconde un principio óptico innovador que, a través de una emisión lateral y suggestiva garantiza un rendimiento luminoso competitivo y una reducción significativa del consumo de energía. Un elemento fluorescente circular difunde su luz a 360°, gracias a un dispositivo óptico en aluminio que mide tan sólo 45 mm de altura: el flujo luminoso se recoge por completo y se orienta hacia el espacio lateralmente, sin molestias para la vista.

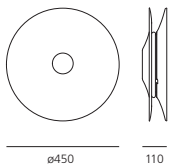

Lunarphase 450

FLUO 1x55W (ZGX13) – T16-R
Lamp included
Not dimmable



Energy Label n°28

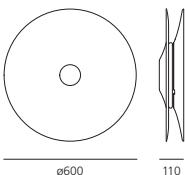

Lunarphase 600

FLUO 1x55W (ZGX13) – T16-R
Lamp included
Not dimmable



Energy Label n°28





Talak parete

design

Neil Poulton
2005, 2007

115 162

Light emission



Colours

Diffuser:
whiteStem:
Mirror

Materiali: supporto parete in alluminio pressofuso; stelo in acciaio cromato lucido; corpo lampada in resina termoplastica verniciata.
Specificità: il corpo lampada ruota sul piano orizzontale ed è regolabile in altezza.

Awards

2005 – “Observateur du Design” 2005
Etoile 2005 A.P.C.I. – Paris (France)
2006 – Design Innovationen Design Zentrum
Nordrhein Westfalen
Reddot Design Award – Product Design
“Best of the Best 2006”
Essen (Deutschland)
2008 – Compasso D’oro / A.D.I.
Segnalazione 2008 – Milano (Italia)

Materials: wall support in diecast aluminium; polished chromed steel stem; body lamp in painted thermoplastic resin.

Specification: the body lamp rotates on the horizontal plane and is adjustable in height.

Matériaux : support applique en aluminium moulé ; tige en acier poli chromé, corps en résine thermoplastique vernie.

Spécificité : le corps de la lampe s’oriente sur le plan horizontal et se règle en hauteur.

Materialien: Wandbefestigung aus Aluminium; Stab aus Stahl, Chrom poliert; Leuchtenkörper aus lackiertem Kunstharz.

Spezifikation: Der Leuchtenkörper kann horizontal gedreht werden und ist höhenverstellbar.

Materiales: soporte pared en aluminio presofuso; tija en acero cromado brillante; cuerpo de la lámpara en resina termoplástica pintada.

Especificaciones: el cuerpo de la lámpara gira en sentido horizontal y es regulable en altura.

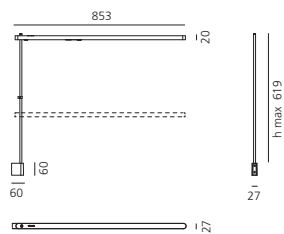

LED Total power 8W
Color temperature 3000K
Lighting output 387lm



+ Microswitch dimmer

Energy Label n°1





Flashit

design

Massimo Tassone
2014

Light emission



Colours



White

Una linea di luce orientabile, adatta ad ogni situazione del living moderno. **Materiali:** struttura in alluminio; schermo in metacrilato con finitura satinata.

Specificità: si fissa alle pareti o al soffitto senza vincoli tradizionali di posizionamento: la lampada può essere installata in modo verticale, orizzontale, obliqua. Alle due estremità, un sistema cinematico composto da calamite, permette la regolazione della direzione del flusso luminoso a seconda delle diverse esigenze.

An adjustable, flexible line of light allowing multiple lighting solutions for every living environment.

Materials: aluminium frame; methacrylate screen with satin finish.

Specification: the profile is fixed to the wall or to the ceiling without any restrictions, as the lamp can be installed vertically, horizontally, or obliquely. At both ends, a kinematic system based on magnets allows to adjust the direction of the luminous flow according to individual needs.

C'est une ligne de lumière orientable adaptée à toute situation d'un espace à vivre.

Matériaux : structure en aluminium, écran en méthacrylate avec une finition satinée.

Spécificités : le produit peut être fixé au mur et au plafond sans aucune contrainte de positionnement. La lampe peut être installée de manière verticale, horizontale ou oblique. Aux deux extrémités, un système cinématique composé d'aimants permet le réglage de la direction du flux lumineux selon les différentes exigences.

Eine ausrichtbare Lichtlinie für moderne Wohnambiente.

Materialien: Struktur aus Aluminium; Schirm aus Methacrylat mit opalinem Finish.

Spezifikation: Lässt sich problemlos ohne herkömmliche Positionierungs einschränkungen vertikal, horizontal oder schräg an Wänden oder Decken anbringen. Über ein kinematisches System auf der Basis von Magneten an beiden Enden des Objekts kann die Ausrichtung des Lichts entsprechend der jeweiligen Anforderungen vorgenommen werden.

Una línea de luz orientable, adaptable a cada situación de la vida moderna.

Materiales: estructura en aluminio, pantalla en metacrilato con acabado satinado.

Especificaciones: el perfil se fija a la pared o al techo sin ninguna de las restricciones de posición tradicional: la lámpara se puede instalar de manera vertical, horizontal, oblicua. En ambos extremos, un sistema cinemático basado en imanes permite ajustar la dirección del flujo luminoso de acuerdo a las necesidades individuales.

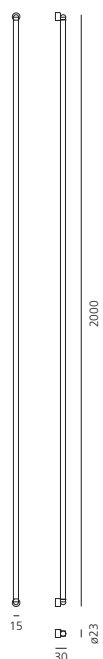

LED Total power 27W
Color temperature 3000K
Lighting output 180lm

IP20  EREC

+  - Dimmer

Energy Label n°1





Tolomeo parete
Tolomeo mini parete
Tolomeo midi parete
Tolomeo micro parete
Tolomeo braccio

design

Michele De Lucchi
Giancarlo Fassina
1987, 1991, 1996, 2000, 2006, 2010

TW Tunable white

Light emission



Materiali: struttura a bracci mobili in alluminio lucidato; diffusore in alluminio anodizzato opaco o alluminio brillantato; snodi e supporto parete in alluminio brillantato.
Specificità: sistema di equilibratura a molle.

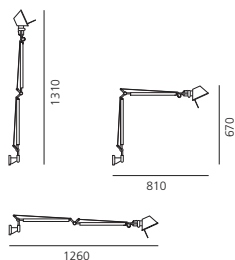

Tolomeo parete LED

LED Total power 10W
Color temperature 3000K
Lighting output 410lm



+ Microswitch dimmer

Energy Label n°1

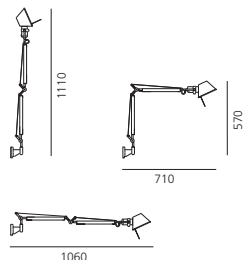

Tolomeo mini parete LED

LED Total power 10W
Color temperature 3000K
Lighting output 410lm



+ Microswitch dimmer

Energy Label n°1

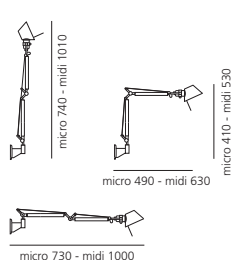

Tolomeo micro parete LED

3 LED Direct emission
+ 1 LED Indirect emission
Total power 8W
Color temperature 3000K
Lighting output 350lm



+ Microswitch dimmer

Energy Label n°1

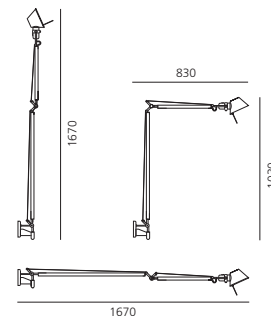

Tolomeo braccio LED

5 LED Direct emission
Total power 10W
Color temperature 3000K
Lighting output 410lm



+ Microswitch dimmer

Energy Label n°1

Tolomeo parete LED TW

LED Total power 12W
Warm-Cold white 3000K-10000K
Lighting output 550lm



+ Microswitch dimmer

Energy Label n°1

Tolomeo mini parete LED TW

LED Total power 12W
Warm-Cold white 2300K-10000K
Lighting output 550lm



+ Microswitch dimmer

Energy Label n°1

Tolomeo midi parete LED

LED Total power 9W
Color temperature 3000K
Lighting output 350lm



+ Microswitch dimmer

Energy Label n°1

Tolomeo parete Fluo

FLUO 1x18W (G24q-2) – TC-DEL
Lamp included
Darklight louvre included
With electronic ballast



Energy Label n°35

Tolomeo mini parete Fluo

FLUO 1x18W (G24q-2) – TC-DEL
Lamp included
Darklight louvre included
With electronic ballast



Energy Label n°35

Tolomeo parete Halo

HALO max 1x77W (E27)
Lamp included



Energy Label n°29

Tolomeo mini parete Halo

HALO max 1x77W (E27)
Lamp included



Energy Label n°29

Tolomeo micro parete Halo

HALO max 1x46W (E14)



Energy Label n°30

Tolomeo braccio Halo

HALO max 1x77W (E27)



Energy Label n°6

Tolomeo Halo

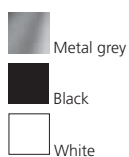

Tolomeo Fluo

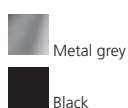

Tolomeo mini Halo

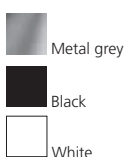

Tolomeo mini Fluo



Tolomeo micro Halo



Tolomeo micro LED, midi LED



Tolomeo braccio Halo, LED



Tolomeo LED, LED TW



Tolomeo mini LED, LED TW



Patent Pending
n. 11161968.0

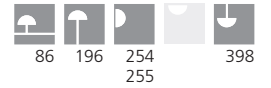

Awards

Tolomeo parete
1989 – Compasso d'Oro / ADI
Milano (Italia)

Materials: cantilevered arms in polished aluminium; diffuser in matt anodised or polished aluminium; joints and wall support in polished aluminium.

Specification: system of spring balancing.

Matériaux : structure à bras articulés en aluminium poli; diffuseur en aluminium anodisé opaque ou aluminium brillant ; rotules et support applique en aluminium brillant.

Spécificité : système d'équilibrage à ressorts.

Materialien: Verstellbare Leuchtenarme aus glänzendem Aluminium; Leuchtenkopf aus matt eloxiertem oder poliertem Aluminium; Gelenke und Arm der Wandleuchte aus poliertem Aluminium.

Spezifikation: Mit Federausgleichsystem.

Materiales: estructura de brazos móviles, de aluminio pulido; difusor de aluminio anodizado mate o brillante; articulaciones y soporte de pared, de aluminio brillante.

Especificaciones: sistema de compensación dinámica de resortes.



Tolomeo parete
Tolomeo mini parete



Tolomeo braccio

Tolomeo faretto

Tolomeo micro faretto

design

Michele De Lucchi
Giancarlo Piretti
1995, 2000, 2010

Patent Pending
n. 11161968.0

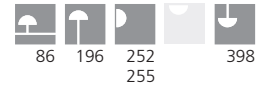

Light emission



Colour



Materiali: supporto parete in alluminio lucidato; diffusore in alluminio anodizzato opaco.

Specificità: disponibili con o senza interruttore.

Materials: wall support in polished aluminium; diffuser in matt anodised aluminium.

Matériaux : support applique en aluminium poli ; diffuseur en aluminium anodisé opaque.

Materialien: Sockel der Wandleuchte aus glänzendem Aluminium; Kopf aus matt eloxiertem Aluminium.

Materiales: soporte de aplique, de aluminio pulido; difusor de aluminio o anodizado mate.

Specification: available with or without switch.

Spécificité : disponible avec ou sans interrupteur.

Spezifikation: Erhältlich mit oder ohne Schalter.

Especificaciones: disponible con interruptor o sin interruptor.

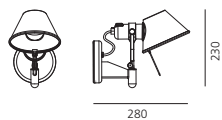
**Tolomeo faretto LED**

5 Direct emission LED
Total power 10W
Color temperature 3000K
Lighting output 410lm

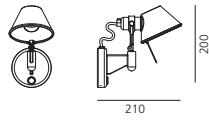

Energy Label n°1

**Tolomeo micro faretto LED**

3 LED Direct emission
+ 1 LED Indirect emission
Total power 8W
Color temperature 3000K
Lighting output 350lm



Energy Label n°1

Tolomeo faretto LED with push button

5 Direct emission LED
Total power 10W
Color temperature 3000K
Lighting output 410lm



+ Microswitch dimmer

Energy Label n°1

Tolomeo micro faretto LED with push button

3 LED Direct emission
+ 1 LED Indirect emission
Total power 8W
Color temperature 3000K
Lighting output 350lm



+ Microswitch dimmer

Energy Label n°1

Tolomeo micro faretto Halo

HALO max 1x46W (E14)
Dimmable



Energy Label n°30

Tolomeo faretto Halo

HALO max 1x77W (E27)
Dimmable



Energy Label n°6

Tolomeo micro faretto Halo with push button

HALO max 1x46W (E14)



Energy Label n°30



Tolomeo faretto with push button

Tolomeo micro faretto with push button

Tolomeo pinza

Tolomeo micro pinza

design

Michele De Lucchi
Giancarlo Fassina
1995, 2000, 2010

Patent Pending
n. 11161968.0

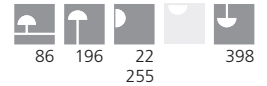

Light emission



Colours

Tolomeo pinza



Tolomeo micro pinza



Materiali: supporto in alluminio lucidato; diffusore in alluminio anodizzato opaco; pinza in acciaio.

Materials: support in polished aluminium, diffuser in matt anodised aluminium; clip in steel.

Matériaux : support en aluminium poli ; diffuseur en aluminium anodisé mat, pince en acier.

Materialien: Halterung aus poliertem Aluminium; Kopf aus matt eloxiertem Aluminium; Klemme aus Stahl.

Materiales: soporte de aluminio pulido; difusor de aluminio anodizado mate; pinza de acero.

Awards

1996 – iF Product Design Award
Hannover (Deutschland)
1996 – “D’Excellence Marie-Claire Maison”
Paris (France)

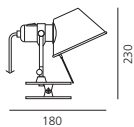

Tolomeo pinza LED

5 LED Direct emission
Total power 10W
Color temperature 3000K
Lighting output 410lm



Energy Label n°1

Tolomeo pinza Halo

HALO max 1x77W (E27)



Energy Label n°6

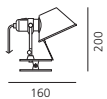

Tolomeo micro pinza LED

3 LED Direct emission
+ 1 LED Indirect emission
Total power 8 W
Color temperature 3000K
Lighting output 350lm



Energy Label n°1

Tolomeo micro pinza Halo

HALO max 1x46W (E14)



Energy Label n°30



Tolomeo pinza

Tolomeo micro pinza

Light emission



Colours



Materiali: struttura a bracci mobili in alluminio lucidato; diffusore in carta pergamena o in raso di seta supportato da materiale plastico; supporto parete in alluminio brillantato.
Specificità: il diffusore, nel normale utilizzo, si dispone verticalmente, indipendentemente dall'angolazione del braccio. Sistema di equilibratura a molle.

Materials: cantilevered arms in polished aluminium; diffuser in parchment paper or in silk satin fabric on a plastic frame; wall support in polished aluminium.

Matériaux: structure à bras articulés en aluminium poli; diffuseur en papier parchemin ou en polycarbonate recouvert de satin de soie ; support applique en aluminium brillant.

Materialien: Ausrichtbare Arme aus glänzendem Aluminium; Schirm aus mit Kunststoff stabilisiertem Pergamentpapier oder Seidensatin; Wandhalterung aus poliertem Aluminium. Federausgleichsystem.

Materiales: base y estructura con brazos móviles de aluminio pulido; difusor en pergamino o en raso seda reforzado con plástico; articulaciones de aluminio pulido. Soporte aplique de aluminio pulido.

Specification: the diffuser normally used, remains vertical regardless of the angle of the arm. System of spring balancing.

Spécificité: le diffuseur dans le cadre d'une utilisation normale, se place verticalement, indépendamment de la position du bras. Système d'équilibrage à ressorts.

Spezifikation: Der Schirm steht normalerweise in vertikaler Position, unabhängig von der Ausrichtung des Armes. Federausgleichsystem.

Especificaciones: en su uso normal, el difusor se dispone verticalmente, independientemente de la angulación del brazo. Sistema de equilibrado a muelles.

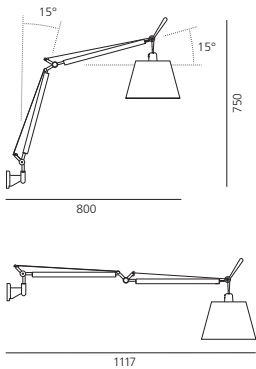

HALO max 1x100W (E27)
or FLUO max 1x20W (E27)



Energy Label n°6





Tolomeo mega parete

design

Michele De Lucchi
Giancarlo Fassina
2003

Light emission



Colours

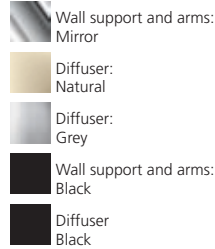

Materiali: struttura a bracci mobili in alluminio lucidato; diffusore in carta pergamena, in raso di seta o in tessuto nero supportato da materiale plastico; supporto parete in alluminio brillantato.
Specificità: diffusore disponibile in tre dimensioni, orientabile in tutte le direzioni. Sistema di equilibratura a molle.

Materials: cantilevered arms in polished aluminium; diffuser in parchment paper, in silk satin or in black fabric on a plastic frame; wall support in polished aluminium.

Specification: diffuser, available in three sizes, adjustable in all directions. System of spring balancing.

Matériaux : structure à bras articulés en aluminium poli; diffuseur en papier parchemin, en polycarbonate recouvert de satin de soie gris ou noir ; support applique en aluminium brillant.

Spécificité : diffuseur disponible en trois tailles, orientable dans toutes les directions. Système d'équilibrage à ressorts.

Materialien: Ausrichtbare Arme aus glänzendem Aluminium; Schirm aus mit Kunststoff stabilisiertem Pergamentpapier, Seidensatin oder schwarzem Gewebe. Wandhalterung aus poliertem Aluminium.

Spezifikation: Der Leuchtenkopf, erhältlich in drei Größen, lässt sich in alle Richtungen verstellen. Federausgleichsystem.

Materiales: base y estructura con brazos móviles de aluminio pulido; difusor en pergamino, en raso seda o en tejido negro reforzado con plástico; articulaciones de aluminio pulido. Soporte aplique de aluminio pulido.

Especificaciones: difusor disponible en tres tamaños, orientable en todas direcciones. Sistema de equilibrado a muelles.

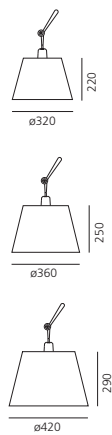
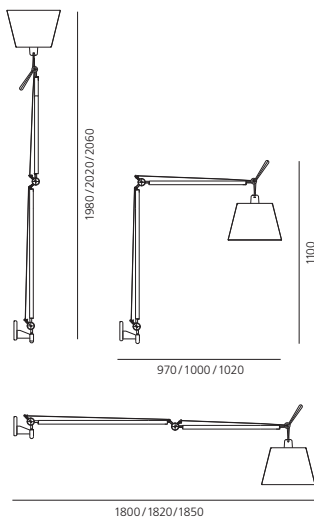

Tolomeo mega parete LED

LED Total power 31W
Color temperature 3000K
Lighting output natural diffuser 1855lm
Lighting output grey diffuser 1800lm
Lighting output black diffuser 1545lm



+ - Dimmer on chord
or
+ - Microswitch dimmer

Energy Label n°1

Tolomeo mega parete Halo

HALO max 1x150W (E27)



+ - Microswitch dimmer

Energy Label n°4

HALO max 1x150W (E27)
or FLUO max 1x23W (E27)
Switch on/off

Energy Label n°6



Tolomeo 18 parete diffusore
 Tolomeo 24 parete diffusore
 Tolomeo 32 parete diffusore

design
 Michele De Lucchi
 Giancarlo Fassina
 2006

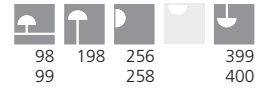

Light emission



Colours



Materiali: braccio in alluminio lucidato; supporto parete in alluminio brillatato; diffusore in carta pergamena o in raso di seta supportato da materiale plastico.

Specificità: il braccio presenta uno snodo che permette al diffusore di ruotare di circa 30° perpendicolarmente alla parete.

Materials: arm and wall support in polished aluminium; diffuser in parchment paper or in silk satin fabric on a plastic frame.

Matériaux : bras en aluminium poli; support applique en aluminium brillant ; diffuseur en papier parchemin ou en polycarbonate recouvert de satin de soie.

Materialien: Leuchtenarm aus hochglanzpoliertem Aluminium; Wandhalterung aus glänzendem Aluminium; Schirm aus mit Kunststoff stabilisiertem Pergamentpapier oder Seidensatin.

Materiales: brazo de aluminio pulido; soporte de pared de aluminio brillante; difusor en pergamino o en raso seda reforzado con plástico.

Specification: the arm presents an articulation allowing the diffuser to tilt up to 30° perpendicular to the wall.

Spécificité : le bras est doté d'une articulation permettant au diffuseur de tourner d'environ 30° perpendiculairement au mur.

Spezifikation: Der Leuchtenarm ist mit einem Gelenk ausgestattet, das eine Drehung des Schirms um ca. 30° ermöglicht.

Especificaciones: el brazo posee una articulación, merced a la cual el difusor logra girar a unos 30°, perpendicolarmente a la pared.

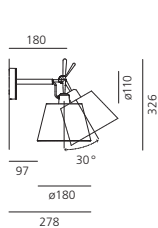

Tolomeo 18 parete diffusore

HALO max 1x46W (E27)
 Dimmable
 (for parchment paper diffuser)
 HALO max 1x100W (E27)
 Dimmable
 or FLUO max 1x16W (E27)
 (for silk satin fabric diffuser)

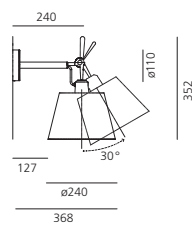

Tolomeo 24 parete diffusore

HALO max 1x100W (E27)
 Dimmable
 or LED max 1x14,5W (E27)



Energy Label n°6

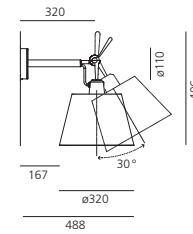

Tolomeo 32 parete diffusore

HALO max 1x150W (E27)
 Dimmable
 or FLUO max 1x23W (E27)
 or LED max 1x17W (E27)



Energy Label n°6

Energy Label n°6



Tolomeo 32 parete diffusore

Tolomeo 24 parete diffusore

Tolomeo 18 parete diffusore

Melampo parete

design

Adrien Gardère
2003



Light emission



Colours



Materiali: attacco parete in alluminio verniciato; diffusore in raso di seta, supportato da materiale plastico.

Specificità: diffusore orientabile in due diverse posizioni.

Materials: wall support in painted aluminium; diffuser in silk satin fabric on a plastic frame.

Matériaux : support applique en aluminium peint ; diffuseur en polycarbonate recouvert de satin de soie.

Materialien: Sockel der Wandleuchte aus lackiertem Aluminium; Schirm aus Seidensatin (stabilisiert mit Kunststoff).

Materiales: soporte de applique de aluminio pintado; difusor en raso seda reforzado con plástico.

Specification: diffuser adjustable into two different positions.

Spécificité : diffuseur orientable dans deux positions.

Spezifikation: Der Schirm ist in zwei unterschiedliche Positionen verstellbar.

Especificaciones: difusor orientable en dos posiciones diferentes.

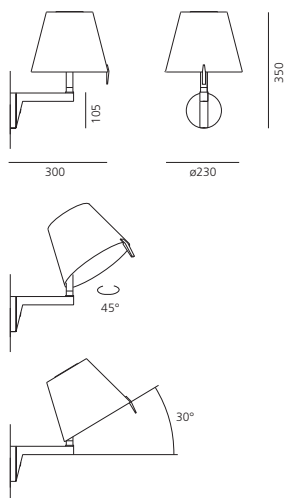

HALO max 1x46W (E14)
Dimmable
or FLUO max 1x11W (E14)
or LED max 1x4,5W (E14)
With or without on/off switch on body lamp



Energy Label n°30

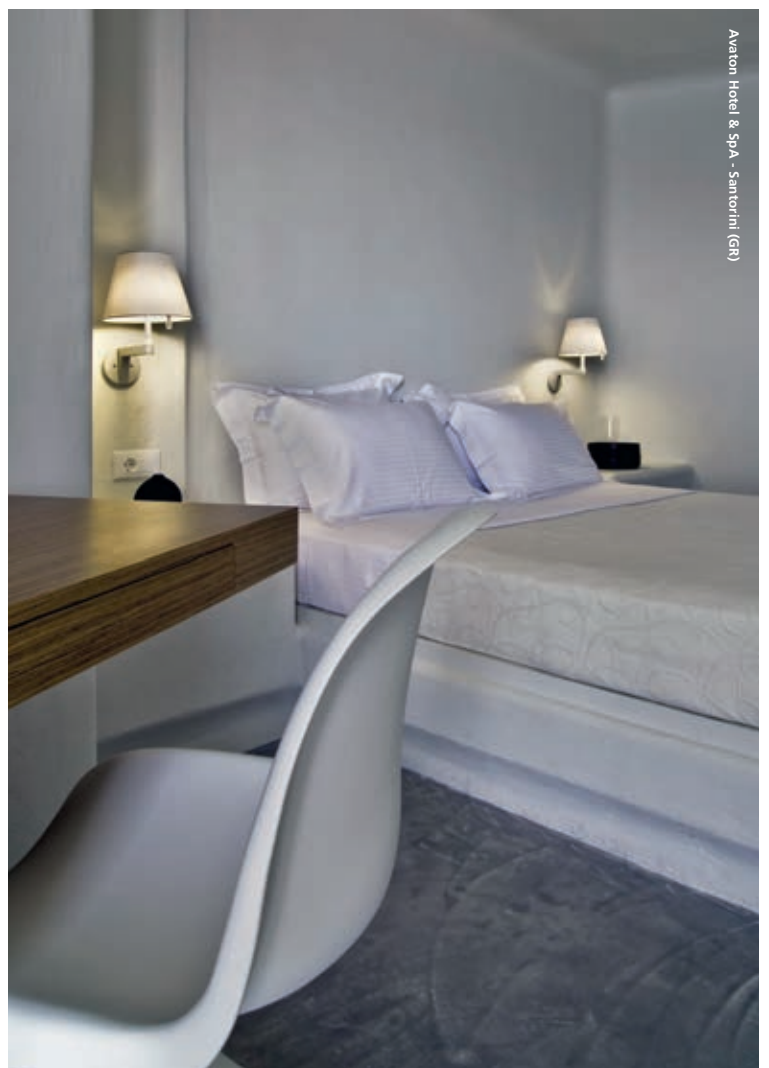



Choose parete
 Choose parete LED
 Choose parete + LED
 Choose incasso LED

design

Matteo Thun
 2006, 2008



Light emission



Colours

Choose parete

 Transparent + Red

 Transparent + Natural

Choose parete + LED

 Transparent + Red

 Transparent + Natural

 LED structure: Grey

Choose LED, Choose incasso LED

 Transparent with White cover

Materiali: struttura in metallo verniciato; diffusore in policarbonato trasparente, accoppiato a un foglio di polipropilene serigrafato rosso o da carta pergamena. Guscio in policarbonato (Choose LED, Choose incasso LED).

Specificità: particolarmente indicate per le camere da letto, abbinando a una luce diffusa un fascio concentrante orientabile LED.

Materials: painted metal structure; diffuser in transparent polycarbonate, joined with red silkscreened polypropylene sheet or with parchment paper. Polycarbonate shell (Choose LED, Choose incasso LED).

Matériaux : structure en métal verni, diffuseur en polycarbonate couplé avec une feuille de polypropylène sérigraphié rouge ou de papier parchemin. Coque en polycarbonate (Choose LED, Choose incasso LED)

Materialien: Lackierte Metallstruktur; Leuchtschirm aus Polycarbonat, mit rot bedrucktem Polypropylen oder Pergamentpapier. Gehäuse aus Polycarbonat (Choose LED, Choose incasso LED).

Materiales: estructura metálica pintada; difusor de policarbonato, junto con una lámina de polipropileno con serigrafía roja o con papel pergamino. Choose LED y Choose incasso LED: carcasa de policarbonato.

Specification: fitting specifically designed for bedrooms, a diffused light together with an LED-powered adjustable spotlight.

Spécificité : particulièrement destinée à la chambre à coucher, elle procure une lumière diffuse avec un flux concentré et orientable grâce au LED.

Spezifikation: Speziell beim Einsatz in Schlafzimmern schafft das diffuse Licht in Verbindung mit der konzentrierten LED-Beleuchtung ein hervorragendes Leselicht.

Especificaciones: especialmente indicadas para dormitorios, junto a una luz difusa otorgan una luz concentrada y orientable LED.



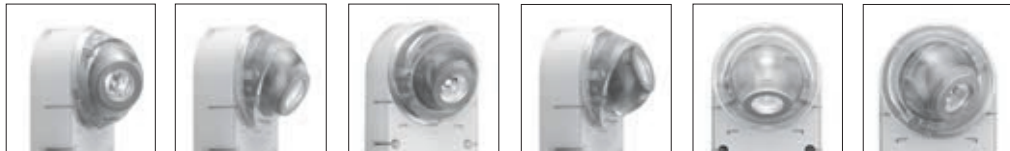

Choose LED

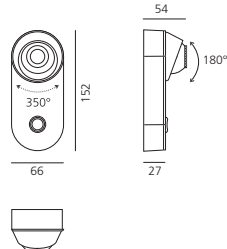
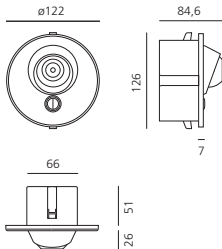
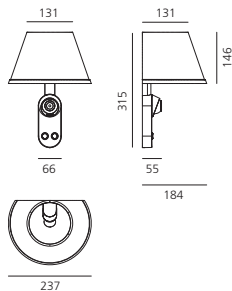
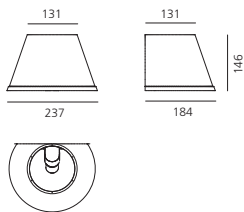

Choose parete Halo

HALO max 1x46W (E14)
On/off switch on body lamp



Energy Label n°30

Choose parete Halo + LED

HALO max 1x46W (E14)
+
LED Total power 1,9W
Color temperature 3000K
Lighting output 65lm
Dual On/off switches on body lamp



Energy Label n°20

Choose incasso LED

LED Total power 1,9W
Color temperature 3000K
Lighting output 65lm
With or without on/off switch on body lamp



Energy Label n°1

Choose parete LED

LED Total power 1,9W
Color temperature 3000K
Lighting output 65lm
On/off switch on body lamp



Energy Label n°1

Choose parete Halo IP23

HALO max 1x46W (E14)
Dimmable



Energy Label n°30



Choose incasso LED



Choose parete + LED

Skopos

design

Ernesto Gismondi
2013

Light emission



Colour



Grey



Black

Apparecchio di illuminazione a parete che utilizza LED ad alto rendimento, composto da una testa faretto con touch dimmer, braccio flessibile e base a parete.

Materiali: testa in pressofusione di alluminio, braccio flessibile in acciaio armonico con copertura esterna in plastica ABS, base a parete in plastica ABS, lente in PMMA.

Specificità: alimentatore integrato.

Light fixture with high-performance LED light sources, composed by a head with touch dim, flexible arm, wall plate.

Luminaire doté de sources LED haute performance, composé d'une tête avec un variateur sensible et d'un bras flexible.

Wandleuchte mit Hochleistungs-LEDs bestehend aus Leuchtenkopf mit Touch Dimmer, flexiblem Arm und Wandbefestigung.

Aparato de iluminación a pared que utiliza LED de alto rendimiento, compuesto por un cabezal spot con touch dimmer, brazo flexible y base a pared.

Materials: Head in injection mould of aluminium, flexible arm in harmonic iron with silicone sleeve, wall bracket in ABS plastic, lens in PMMA.

Matériaux : tête en aluminium injecté moulé, bras flexible en acier harmonique avec manchon de silicone, support mural en plastique ABS, lentille en PMMA.

Materialien: Leuchtenkopf aus spritzgegossenem Aluminium, flexibler Arm aus Eisen mit Silikonüberzug, Wandbefestigung aus Kunststoff, Linse aus Acrylglas.

Materiales: cabeza en aluminio presofuso, brazo flexible en acero armónico con cobertura externa en plástico ABS, base a pared en plástico ABS, lente en PMMA.

Specification: Integrated driver.

Spécificités : Alimentation intégrée.

Spezifikation: Integriertes Vorschaltgerät

Especificaciones: alimentador integrado.

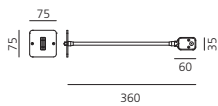

Skopos

LED Total power 2W
Color temperature 3000K
Lighting output 60lm

IP40  

+  Microswitch dimmer

Energy Label n°1



Jet
Jet base

2007



Light emission



Colour



Grey

Apparecchio di illuminazione che impiega LED ad alto rendimento.
Materiali: testa del faretto in tornito d'alluminio, braccio flessibile in acciaio armonico, lente in PMMA, base a parete in lamiera zincata
Specificità: alimentatore integrato.

Light fixture with high-performance LED light sources.

Luminaire doté de sources LED haute performance.

Wandleuchte mit Hochleistungs-LEDs.

Aparato de iluminación que utiliza LED de alto rendimiento.

Materials: Spot head in lathed aluminium, flexible arm in harmonic iron, PMMA lens, base plate in galvanized metal.

Matériaux : tête en aluminium, bras flexible en acier harmonique, lentille PMMA, base en métal galvanisé.

Materialien: Leuchtenkopf aus Aluminium, flexibler Arm aus Eisen, PMMA Linse, Wandplatte aus verzinktem Metall.

Materiales: Cabezal del spot en aluminio torneado, brazo flexible en acero armónico, lente en PMMA, placa base de metal galvanizado.

Specification: Integrated driver.

Spécificités : Alimentation intégrée.

Spezifikation: Integriertes Vorschaltgerät

Especificaciones: alimentador integrado.

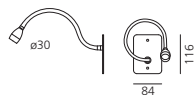
**Jet**

LED Total power 1W
 Color temperature 3000K
 Lighting output 74lm

IP40 ENEC

+ Dimmer

Energy Label n°1

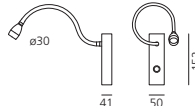
**Jet base**

LED Total power 1W
 Color temperature 3000K
 Lighting output 74lm

IP40 ENEC

+ Microswitch dimmer

Energy Label n°1



Robbia 30
Robbia 60

design
Ennio Pasini
1996



Light emission



Colour



White

Materiali: struttura in metallo verniciato; diffusore in vetro soffiato opalino.

Materials: structure in painted metal; opal blown glass diffuser.

Matériaux : structure en métal verni ; diffuseur en verre soufflé opalin.

Materialien: Struktur aus lackiertem Metall; Schirm aus mundgeblasenem Opalglas.

Materiales: estructura de metal pintado y difusor en cristal soplado opalino.

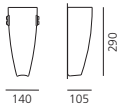

Robbia 30 Fluo

FLUO 1x9W (G23) – TC-S
Not dimmable



Energy Label n°7

Robbia 30 Halo

HALO max 1x77W (E27)
Dimmable



Energy Label n°6

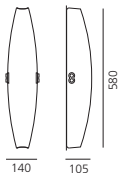

Robbia 60 Fluo

FLUO 2x9W (G23) – TC-S
Not dimmable



Energy Label n°7

Robbia 60 Halo

HALO max 2x77W (E27)
Dimmable



Energy Label n°6





Light emission



Colours



Polished White



Transparent



Anthracite Grey



Transparent Orange

Materiali: policarbonato traslucido (versioni colorate) o in resina termoplastica (versione bianca).

Specificità: possibilità di comporre configurazioni multiple.

Materials: translucent polycarbonate (coloured version); thermoplastic resin (white version).

Matériaux : polycarbonate translucide (versions colorées) où en résine hermoplastique (version blanche).

Materialien: Farbige Ausführungen aus transluzentem Polycarbonat, weiße Ausführung aus Kunstharz.

Materiales: policarbonato traslúcido (versiones color) o de resina termoplástica (versión blanca).

Specification: it is possible to create multiple configurations.

Spécificité: possibilité de créer de multiples applications.

Spezifikation: Die Vielzahl an Kombinationsmöglichkeiten gestattet die Anwendung individueller Konfigurationen.

Especificaciones: posibilidad de componer configuraciones múltiple.

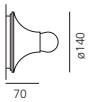

HALO max 1x28W (E27)
Dimmable

IP20  

Energy Label n°30

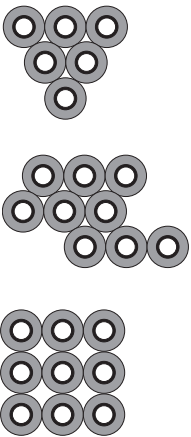

Configuration examples



Telefo 50
Telefo 70
Telefo 120
Telefo 170

design
Örni Halloween
1994, 2003



Light emission



Colours



Structure:
Mirror



Diffuser:
White

Materiali: supporto parete in alluminio; diffusore in metacrilato opalino; testate di chiusura in metallo cromato lucido.

Materials: wall support in aluminium; diffuser in opaline methacrylate; end plates in polished chromed metal.

Matériaux : support applique en aluminium, diffuseur en méthacrylate opalin, extrémités de fermeture en métal chromé brillant.

Materialien: Profil aus Aluminium; Schirm aus opalem Methacrylat; Verschlussklemmen aus verchromtem Metall.

Materiales: soporte aplique en aluminio; difusor en metacrilato opalino; cabezas de cierre en metal cromado brillante.

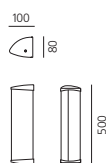

Telefo 50
FLUO 2x11W (G23) – TC-S
Not dimmable

IP44

Energy Label n°34

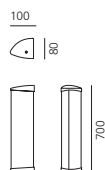

Telefo 70
FLUO 1x18W (G13) – T26
With electronic ballast
Not dimmable

IP20

Energy Label n°34

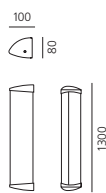

Telefo 120 Fluo
FLUO 1x36W (G13) – T26
With electronic ballast
Not dimmable

IP20

Energy Label n°34

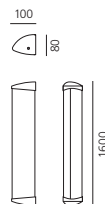

Telefo 170
FLUO 1x58W (G13) – T26
With electronic ballast
Not dimmable

IP20

Energy Label n°34



Telefo 70

Telefo 120

Telefo 170

Pantarei 190
Pantarei 300
Pantarei 390

design
Ernesto Gismondi
1993



Light emission



Colours

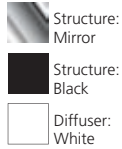

Awards

1995 – Design Innovationen Design Zentrum Nordrhein Westfalen “Design Innovationen” Essen (Deutschland)
1996 – “iF – Die Gute Form” Hannover (Deutschland)

Museums

Museo Nazionale della Scienza e della Tecnica – Milano (Italia)

Materiali: struttura in alluminio brillantato preventivamente fosfocromato. Diffusore in vetro stampato sabbiato o in policarbonato opalino resistente agli urti.

Specificità: versione emergenza installabile solo a parete. Versioni LED grigio silver e nero per esterni (vedi catalogo Artemide Architectural).

Materials: phospho-chromated polished aluminium structure. Diffuser in sanded-blasted glass or shock resistant opal polycarbonate.

Matériaux : structure en aluminium avec traitement de phospho-chromatation. Diffuseur en verre moulé sablé ou en polycarbonate opalin moulé résistant aux chocs.

Materialien: Phospho-chromatisierte, polierte Struktur aus Aluminium. Schirm aus sandgestrahltem Pressglas oder opalem, schlagfestem Polycarbonat.

Materiales: estructura de aluminio preventivamente fosfo-cromado. Difusor de cristal estampado arenado o en policarbonato opalino resistente a los robos.

Specificity: LED silver grey and black version suitable for outdoor use (see Artemide Architectural catalogue). Emergency version only for wall-mounted version.

Spécificité : version LED gris silver et noir pour l'extérieur (voir catalogue Artemide Architectural). Version sécurité seulement pour la version applique.

Spezifikation: Notlichtversion nur als Wandleuchte einsetzbar.

Especificaciones: versiones LED gris silver y negro para exterior (ver catálogo Artemide Architectural). La versión con emergencia sólo en pared.

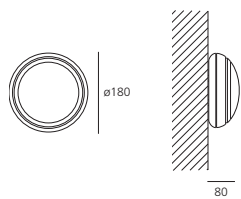

Pantarei 190 LED

LED Total power 11W
Color temperature 3000K
Lighting output glass 381lm
Lighting output polycarbonate 244lm
Electrical power supply included
Not dimmable



Energy Label n°1

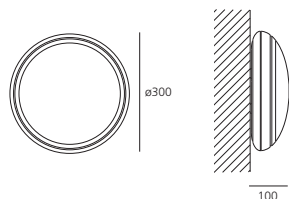

Pantarei 300 LED

LED Total power 14W
Color temperature 3000K
Lighting output glass 497lm
Lighting output polycarbonate 544lm
LED Total power 14W
Color temperature 4000K
Lighting output glass 532lm
Lighting output polycarbonate 582lm
Electrical power supply included
Not dimmable



Energy Label n°1

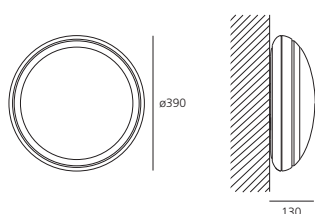

Pantarei 390 LED

LED Total power 30W
Color temperature 3000K
Lighting output glass 960lm
Lighting output polycarbonate 1000lm
Electrical power supply included
Not dimmable



Energy Label n°1



Logico parete
Logico mini parete
Logico micro parete

design

Michele De Lucchi
Gerhard Reichert
2001, 2002



Light emission



Colours

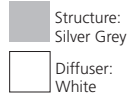

Materiali: struttura in metallo verniciato; diffusore in vetro soffiato con finitura seta lucida. Soffiatura a tre strati (cristallo + effetto seta + cristallo) in stampo a fermo con forma capovolta per garantire solidità strutturale del vetro.

Awards

2002 – Design Innovationen
Design Zentrum Nordrhein Westfalen
Reddot Design Award
Essen (Deutschland)

Materials: painted metal structure, blown glass diffuser with a polished-silk finish. Three layers of glass (crystal + silk + crystal) are blown in an upside down mould to ensure structural consistency to glass.

Matériaux : structure en métal verni ; diffuseur en verre soufflé, finition soie brillante. Verre soufflé en trois couches (cristal + effet soyeux + cristal) dans un moule qui a une forme inversée pour garantir la solidité structurale du verre.

Materialien: Rahmen aus lackiertem Metall; Schirm aus geblasenem Glas in seidig glänzendem Finish. Drei Glasschichten (Kristall + Seide + Kristall) die umgekehrt positioniert sind um die Stabilität des Glases zu gewährleisten.

Materiales: estructura de metal pintado; difusor de cristal soplado con acabado de seda brillante. Soplado a tres capas (cristal + efecto seda + cristal) en un molde con forma invertida para asegurar la resistencia estructural del cristal.

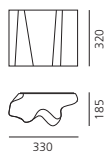

Logico parete Halo

HALO max 2x52W (E27)
Dimmable



Energy Label n°6

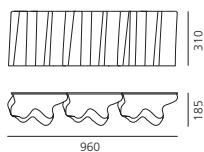

Logico parete 3 in linea Halo

HALO max 6x52W (E27)
Dimmable



Energy Label n°6

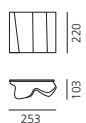

Logico mini parete Halo

HALO max 1x52W (E27)
Dimmable



Energy Label n°6

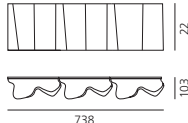

Logico mini parete 3 in linea Halo

HALO max 3x52W (E27)
Dimmable



Energy Label n°6

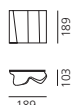

Logico micro parete Halo

HALO max 1x46W (E14)
Dimmable



Energy Label n°30

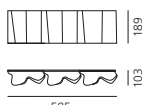

Logico micro parete 3 in linea Halo

HALO max 3x46W (E14)
Dimmable



Energy Label n°30



Custom project, schloess| Oberrotterbach (Germany)
Ph: Werner Hutmacher



Logico parete



Logico parete 3 in linea

Empatia 16 parete/soffitto
Empatia 26 parete/soffitto
Empatia 36 parete/soffitto

design

Carlotta de Bevilacqua
Paola di Arianello
2013



Light emission



Colours



White

Awards

2014 – Wallpaper Design Awards
2014 – iF Product Design Award

Materiali: corpo della lampada in alluminio pressofuso con finitura verniciata; diffusore in vetro soffiato trasparente con finitura seta lucida; guida luce in metacrilato a basso coefficiente di assorbimento.

Materials: painted die-cast aluminium body lamp; diffuser in blown glass with a polished-silk finish; light pipe made of low absorption coefficient methacrylate.

Matériaux : corps en aluminium moulé sous pression peint ; diffuseur en verre soufflé transparent avec finition soie brillante ; guide lumière en méthacrylate à bas coefficient d'absorption.

Materialien: Leuchtenkörper aus druckgegossenem, lackiertem Aluminium; Schirm aus transparentem, mundgeblasenem Glas in seidig glänzendem Finish; Lichtstab aus Methacrylat mit niedrigem Absorptionskoeffizienten.

Materiales: cuerpo de la lámpara en aluminio fundido a presión y pintado; difusor en cristal soplado transparente con acabado seda lúcido; guía de luz en metacrilato de bajo coeficiente de absorción.

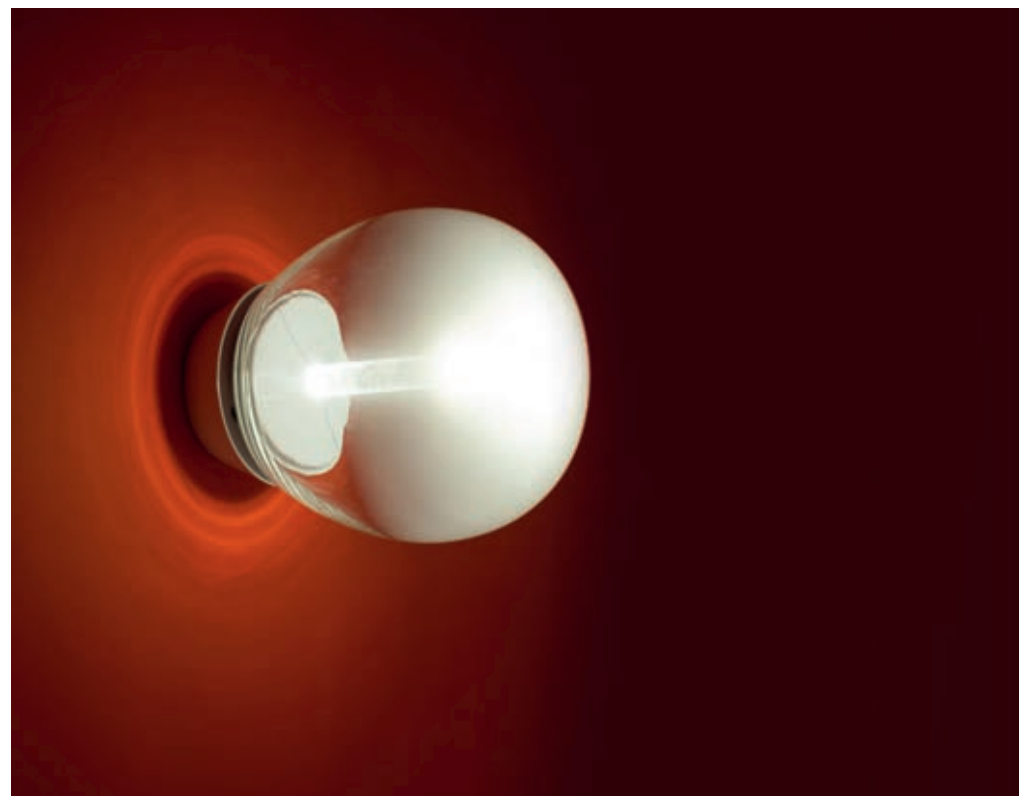
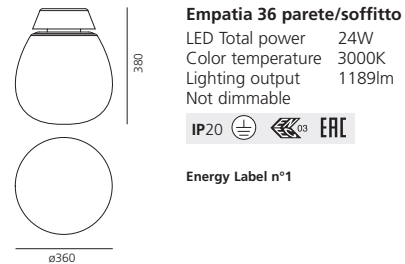
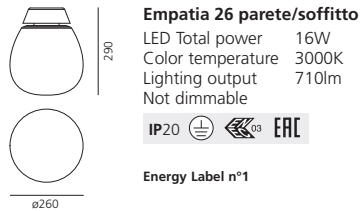
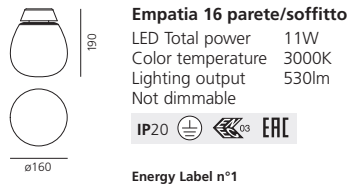



Meteorite 15 parete/soffitto
Meteorite 35 parete/soffitto

design

Pio & Tito Toso
2014



Light emission



Colours



White

Materiali: diffusore in vetro soffiato; corpo della lampada in tecnopolimero.

Materials: blown glass
diffuser; lamp body in
technopolymer.

Matériaux : diffuseur
en verre soufflé ; corps
en techno-polymère.

Materialien: Schirm
aus mundeblasenem Glas;
Leuchtenkörper aus
Technopolymer.

Materiales: difusor
en cristal soplado, cuerpo de
la lámpara en tecnopolímero.

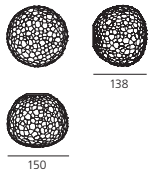

Meteorite 15 parete/soffitto

HALO max 1x48W (G9)
Lamp included
Dimmable



Energy Label n°18

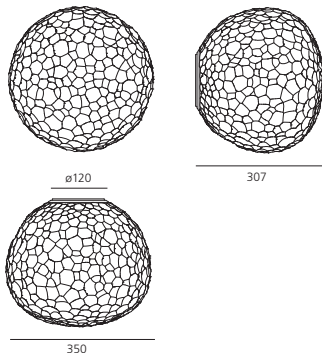

Meteorite 35 parete/soffitto

HALO max 150W (E27)
Dimmable



Energy Label n°4

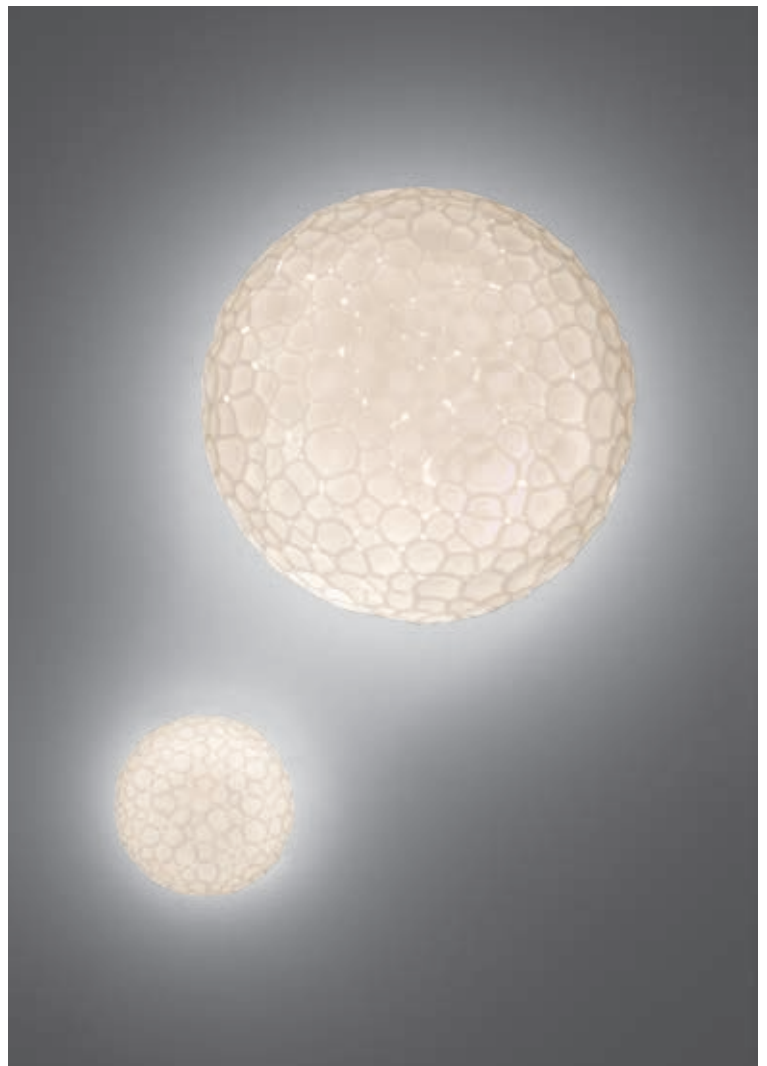

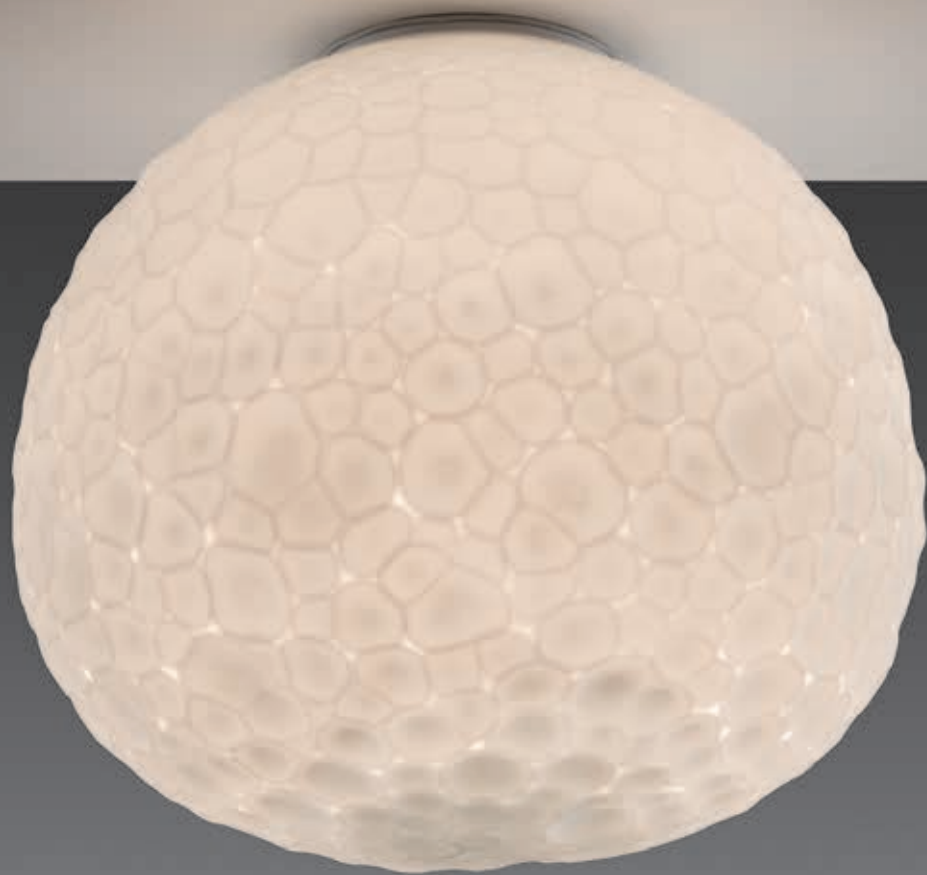

Laguna 16 soffitto
Laguna 26 soffitto
Laguna 37 soffitto

design

Matteo Thun
Antonio Rodriguez
2013



Light emission



Colour



Black brown

Materiali: corpo della lampada in alluminio estruso verniciato nero (black brown); diffusore in vetro soffiato.

Materials: black brown painted lamp body in extruded aluminum; diffuser in blown glass.

Matériaux : corps en aluminium extrudé verni noir (noir brun), diffuseur en verre soufflé.

Materialien: stab aus schwarz-braun lackiertem fließgepresstem Aluminium; Schirm aus mundgeblasenem Glas.

Materiales: cuerpo de la lámpara en aluminio extruido pintado negro (black Brown); difusor en cristal soplado.

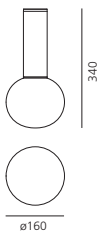

Laguna 16 soffitto

LED Total power 15W
Color temperature 3000K
Lighting output 539lm
Not dimmable

IP20 EAC

Energy Label n°1

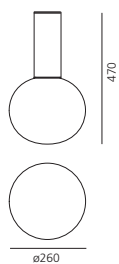

Laguna 26 soffitto

LED Total power 20W
Color temperature 3000K
Lighting output 1211lm
Not dimmable

IP20 EAC

Energy Label n°1

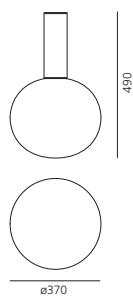

Laguna 37 soffitto

LED Total power 28W
Color temperature 3000K
Lighting output 1881lm
Not dimmable

IP20 EAC

Energy Label n°1





Laguna 26



Laguna 16



Laguna 37

Dioscuri 14 parete/soffitto
 Dioscuri 25 parete/soffitto
 Dioscuri 35 parete/soffitto
 Dioscuri 42 parete/soffitto

design

Michele De Lucchi
 1999, 2003, 2005



124



Light emission



Colour



White

Materiali: supporto parete/soffitto in resina termoplastica; diffusore in vetro soffiato acidato.

Specificità: il grado di protezione IP65 le rende idonee all'utilizzo anche in esterno.

Awards

2000 – Design Innovationen
 Design Zentrum Nordrhein Westfalen
 Reddot Design Award
 Essen (Deutschland)

2000 – Design Plus Light + Building
 Frankfurt am Main (Deutschland)

Materials: thermoplastic resin ceiling support; acid-etched blown glass diffuser.

Matériaux : support en matériau thermoplastique ; diffuseur en verre soufflé traité à l'acide.

Materialien: Deckenbefestigung aus thermoplastischem Harz; Kugel aus mundgeblasenem, geätztem Glas.

Materiales: soporte de resina termoplástica; difusor de cristal soplado al ácido.

Specification: IP65 rating makes it suitable also for outdoor use.

Spécificité : l'indice de protection IP 65 permet l'installation de l'appareil en extérieur.

Spezifikation: Auch in Außenbereichen einsetzbar (Schutzart IP 65).

Especificaciones: el grado de protección IP 65 la hace idónea para exteriores.



Dioscuri 14 parete/soffitto

HALO max 1x48W (G9)
 Lamp included
 Dimmable



Energy Label n°18

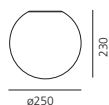

Dioscuri 25 parete/soffitto

HALO max 1x77W (E27)
 Dimmable
 or FLUO 1x20W (E27) – TC-TSE
 or LED max 1x14,5W (E27)



Energy Label n°6

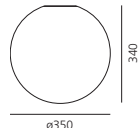

Dioscuri 35 parete/soffitto

HALO max 1x105W (E27)
 Dimmable
 or FLUO 1x23W (E27) – TC-TSE
 or LED max 1x17W (E27)



Energy Label n°6

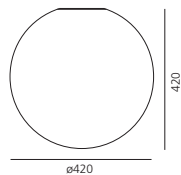

Dioscuri 42 parete/soffitto

HALO max 1x105W (E27)
 Dimmable
 or FLUO 1x23W (E27) – TC-TSE
 or LED max 1x17W (E27)



Energy Label n°6





Miconos parete
Miconos soffitto

design

Ernesto Gismondi
1999, 2000



Light emission



Colour



Structure:
Mirror



Diffuser:
Transparent

Materiali: struttura in metallo cromato lucido; diffusore in vetro soffiato trasparente.

Materials: structure in polished chromed metal, diffuser in transparent blown glass.

Matériaux : structure en métal chromé brillant, diffuseur en verre soufflé transparent.

Materialien: Struktur aus poliertem und verchromtem Metall, Schirm aus klarem, mundeblasenem Glas.

Materiales: estructura, de metal cromado brillante; difusor en cristal soplado transparente.

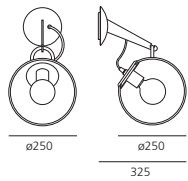

Miconos parete

FLUO max 1x20W (E27) – globe ø 9cm
Not dimmable



Energy Label n°9

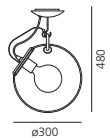

Miconos soffitto

FLUO max 1x20W (E27) – globe ø 12cm
Not dimmable



Energy Label n°9



Miconos parete



Carlotta de Bevilacqua
2008

Light emission



Colour



“Un m² di superficie dove la luce scorre fluida su fili trasparenti che attraverso un riflettore a specchio materializza un effetto luminoso volumetrico e controllato. È un m³ di luce nel quale ci si riflette all’infinito modulando liberamente più di un milione di effetti cromatici. Lo spazio non è più uno, ma diventa molti o semplicemente altro, percezione illusoria della realtà che porta verso un nuovo luogo, altrove.”

Materiali: struttura perimetrale in alluminio a specchio; diffusori laterali in Prismoptic satinato; diffusore frontale in metacrilato trasparente inciso.
Specificità: sono disponibili due versioni che emettono luci differenti a seconda del riflettore:

Luce fluida: con riflettore in alluminio lucido a specchio.

Luce volumetrica: alluminio lucido a specchio a segmenti ottici.

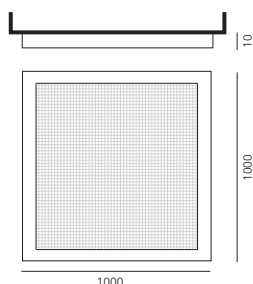

FLUO 2x3 RGB groups (tot. 6) x 39W (G5) – T16
(234W total power)
Lamp included
With electronic ballast
Dimmable

IP20  EAC

Energy Label n°38



Radiofrequency
remote control
(included)

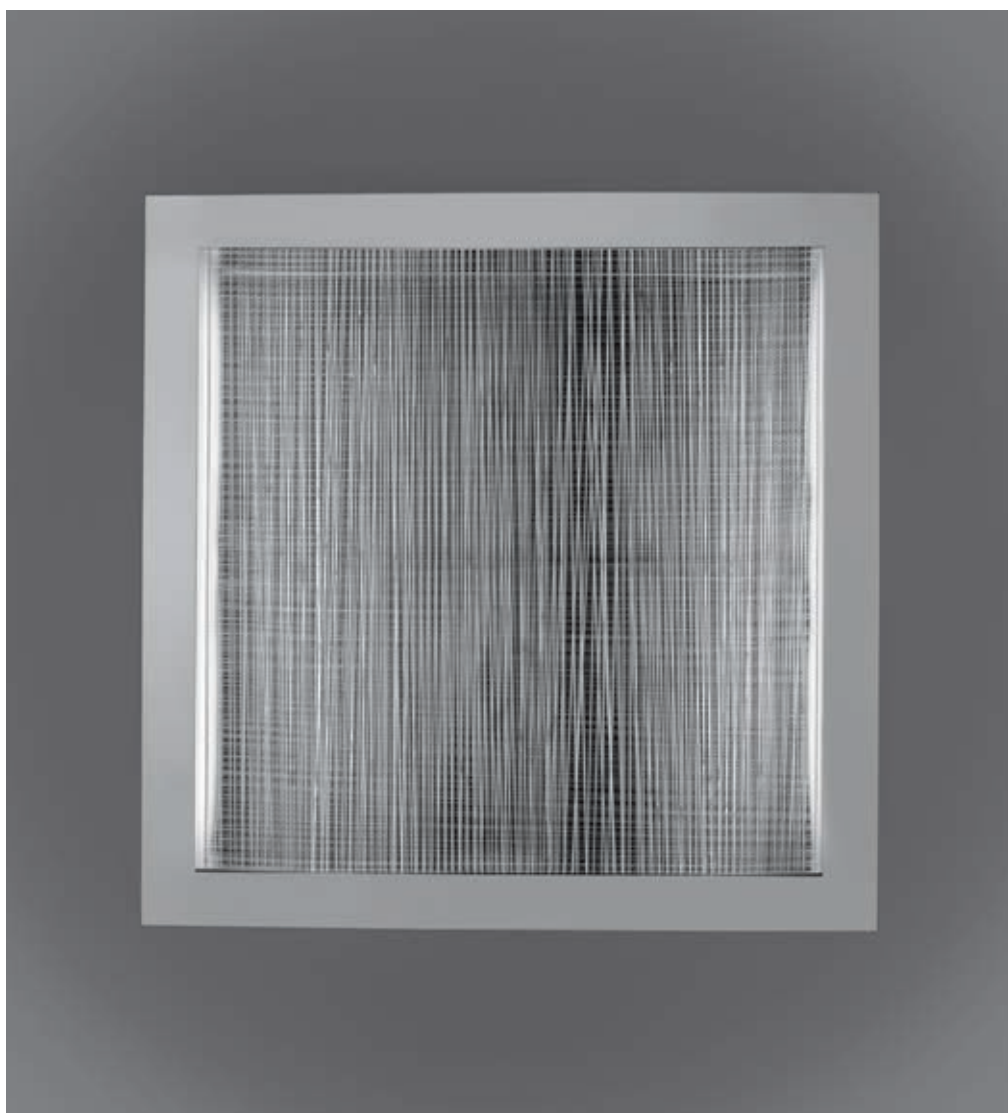

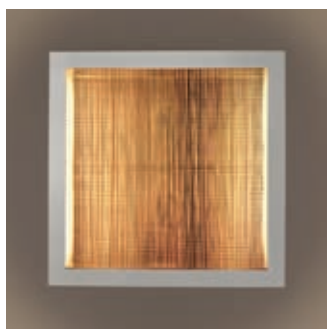

A square metre surface where the light flows fluidly on transparent wires and, through a mirrored reflector, creates controlled lighting and volumetric effects. A cubic metre of light in which endless reflections can be created by freely modulating more than a million chromatic effects. There is no longer one space but several, or simply another deceptive perception of reality leading to a new place, elsewhere.

Un m² de surface où la lumière entre avec fluidité sur des fils transparents et au travers d'un réflecteur miroir. Autre matérialise un éclairage à effet volumétrique commandé. C'est un mètre cube de lumière où celle-ci se réfléchit sans fin et qui module librement plus d'un million d'effets chromatiques. L'espace n'en est plus un mais plusieurs perception illusoire de la réalité, qui mène à un nouvel endroit, ailleurs.

Auf einer Fläche von einem Quadratmeter wird das Licht in fließender Bewegung über transparente Nylonkabel geleitet, durch eine Spiegelfläche reflektiert, materialisiert und erzeugt einen einzigartigen Volumeneffekt. Aus einem Quadratmeter Licht, welches endlos reflektiert wird, werden Millionen farbige Effekte erzeugt. Die Fläche hat damit nicht mehr nur eine, sondern viele oder einfach "weitere" scheinbare Wahrnehmungen der Realität, die zu einer neuen Dimension führen.

Para materializar un efecto luminoso volumétrico y controlado, se ha creado un metro cuadrado de superficie donde la luz discurre con fluidez sobre hilos transparentes que cruzan un reflector en forma de espejo. Se trata de un metro cúbico de luz en el cual refleja hacia el infinito modulando libremente más de un millón de efectos cromáticos. El espacio ya no es único, sino que se convierte en una multitud de espacios o simplemente en uno distinto, en una percepción ilusoria de la realidad que nos conduce a un nuevo lugar, más allá.

Materials: perimeter structure made of mirrored aluminium; side diffusers made of satin Prismoptic; front diffuser in engraved transparent methacrylate.

Matériaux : périmètre de la structure en aluminium ; diffuseurs latéraux en Prismoptic opalin ; diffuseur frontal en méthacrylate transparent strié.

Materialien: Rahmen aus verspiegeltem Aluminium; seitliche Reflektoren mit opaliner Prismoptic; Frontscheibe aus transparentem, graviertem Metacrylat.

Materiales: estructura perimetral de aluminio, difusores laterales de Prismoptic opalino, difusor frontal de metacrilato transparente.

Specification: available in two version with different reflectors:

Fluid light: with mirrored aluminium reflector.

Volumetric light: with optical segment reflector in mirrored aluminium.

Spécificité : deux versions sont disponibles avec deux types de réflecteur :

Lumière fluide : avec réflecteur miroir.

Lumière volumétrique : avec lames de réflecteur miroir.

Spezifikation: Erhältlich in zwei Versionen:

Fließendes Licht: Reflektor aus verspiegeltem Aluminium.

Volumen erzeugendes Licht: Lamelleneffektor aus verspiegeltem Aluminium.

Especificaciones: están disponibles dos versiones que se caracterizan por dos tipos de reflector:

Luz fluida: con reflector en acabado espejo.
Luz volumétrica: con reflector de segmentos ópticos.

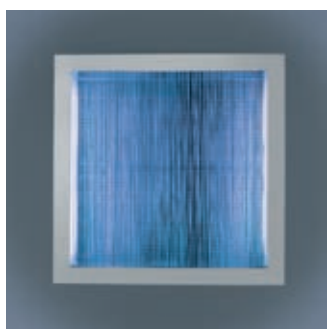
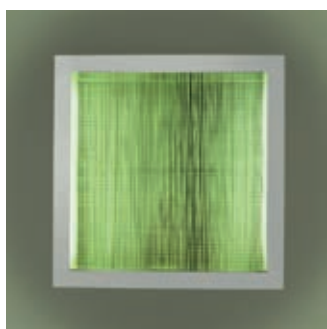

Teatro Franco Parenti, Milan (IT)
Ph: Miro Zagnoli

Light emission



Colour



Mirror

Versione della lampada Altrove a luce bianca, in cui è possibile combinare la temperatura di colore dimmerando le sorgenti calde e fredde attraverso due pulsanti a parete.

Materiali: struttura perimetrale in alluminio a specchio; diffusori laterali in Prismoptic satinato; diffusore frontale in metacrilato trasparente inciso.

Specificità: sono disponibili due versioni che emettono luci differenti a seconda del riflettore.

Luce fluida: con riflettore in alluminio lucido a specchio.

Luce volumetrica: alluminio lucido a specchio a segmenti ottici.

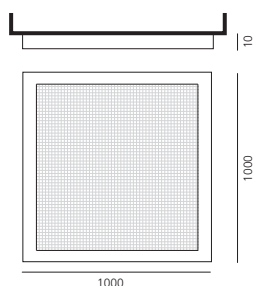

FLUO 2x39W (G5) – T16
Color temperature 3000K
+
FLUO 2x39W (G5) – T16
Cold white 6500K
Lamp included
With electronic ballast
Dimmable



Energy Label n°22

Altrove Tunable White allows the adjustment of colour temperature through two wall-mounted dimmable switches.

Materials: perimeter structure made of mirrored aluminium; side diffusers made of satin Prismoptic; front diffuser in engraved transparent methacrylate.

Specification: available in two version with different reflectors:

Fluid light: with mirrored aluminium reflector.

Volumetric light: with optical segment reflector in mirrored aluminium.

Version du modèle Altrove à lumière blanche avec lequel il est possible de gérer la température de couleur à l'aide de deux variateurs déportés.

Matériaux : périmètre de la structure en aluminium; diffuseurs latéraux en Prismoptic opalin ; diffuseur frontal en méthacrylate transparent strié.

Spécificité : deux versions sont disponibles avec deux types de réflecteur :

Lumière fluide : avec réflecteur miroir.

Lumière volumétrique : avec lames de réflecteur miroir.

Weißlicht-Version der Altrove Wand-/Deckenleuchte. Die Regelung der Farbtemperatur erfolgt über zwei Wandschalter mit Dimmung.

Materialien: Rahmen aus verspiegeltem Aluminium; seitliche Reflektoren mit opaliner Prismoptic; Frontscheibe aus transparentem, graviertem Methacrylat.

Spezifikation: Erhältlich in zwei Versionen:

Fließendes Licht: Reflektor aus verspiegeltem Aluminium.

Volumen erzeugendes Licht: Lamellenreflektor aus verspiegeltem Aluminium.

Altrove versión Tunable Light, en la cual es posible combinar la temperatura de color fría o cálida a través de dos interruptores de pared dimerizables.

Materiales: estructura perimetral de aluminio, difusores laterales de Prismoptic opalino, difusor frontal de metacrilato transparente.

Especificaciones: están disponibles dos versiones que se caracterizan por dos tipos de reflector:

Luz fluida: con reflector en acabado espejo.

Luz volumétrica: con reflector de segmentos ópticos.

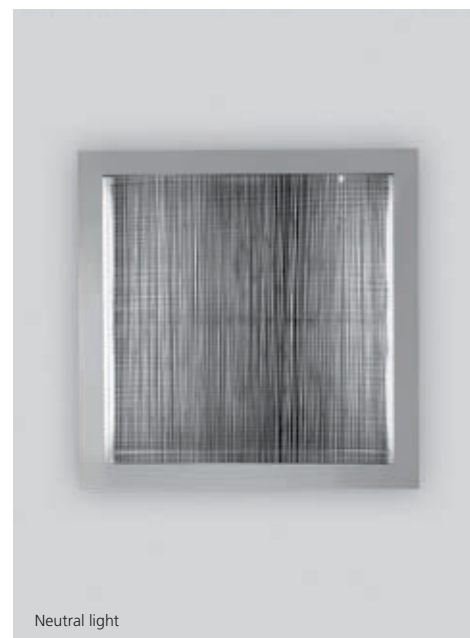
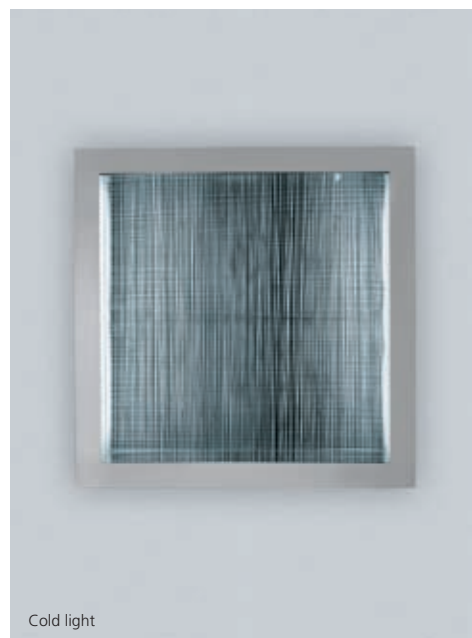



Light emission



Colour



Mirror

Materiali: struttura perimetrale in acciaio inox a specchio; diffusori laterali in Prismoptic satinato; riflettore in alluminio lucido a specchio; diffusore frontale in metacrilato trasparente inciso.

Specificità: due aperture lungo due lati opposti della struttura perimetrale permettono di ottenere anche un'emissione wall washer sulla parete.

600

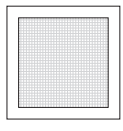

FLUO 2x55W (2G11) – TC-LEL
Lamp included
With electronic ballast
Dimmable



Energy Label n°33

Materials: perimeter structure made of mirrored aluminium; side diffusers made of satin Prismoptic; front diffuser in engraved transparent methacrylate.

Specification: two gaps along opposite sides of the perimeter structure create a wall washer emission on the wall.

Matériaux : structure périmétrale en acier inoxydable miroitant, diffuseurs latéraux Prismoptic satiné ; réflecteur en aluminium poli et miroitant ; diffuseur frontal en méthacrylate transparent gravé.

Spécificité : sur les deux côtés opposés de la structure périmétrale, deux ouvertures permettent également d'obtenir une émission wall washer sur le mur.

Materialien: Rahmen aus verspiegeltem Edelstahl; seitliche Reflektoren mit opaliner Prismoptic; Frontscheibe aus transparentem, gravierten Metacrylat.

Spezifikation: Auf den beiden entgegengesetzten Seiten des Rahmens schaffen zwei Öffnungen einen auf die Wand gerichteten Wall Washer-Effekt.

Materiales: estructura perimétrica de acero inoxidable con acabado espejo. Difusores laterales de Prismoptic satinado. Reflector de aluminio brillante con acabado espejo. Difusor frontal de metacrilato transparente grabado.

Especificaciones: dos aberturas, a lo largo de dos lados opuestos de la estructura perimétrica, permiten obtener asimismo un efecto baño de luz contra los paramentos.



Droplet mini parete/soffitto

design

Ross Lovegrove
2009, 2011



Light emission



Colours



Materiali: corpo luminoso in alluminio pressofuso; riflettore in alluminio stampato e verniciato.

Materials: die-cast aluminium lighting unit; painted die-cast aluminium reflector.

Matériaux : corps lumineux en aluminium moulé sous pression. Réflecteur en aluminium moulé et verni.

Materialien: Leuchtenkörper aus druckgegossenem Aluminium; Reflektor aus formgestanztem Aluminium.

Materiales: cuerpos luminosos en aluminio fundido a presión; reflector en aluminio moldeado y pintado.

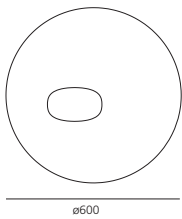
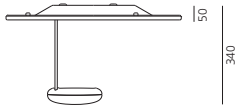

Droplet mini LED

LED Total power 29W
Color temperature 3000K
Lighting output 2330lm
Dimmable



Energy Label n°1

Droplet mini Halo

HALO max 1x160W (R7s)
Lamp included
Dimmable



Energy Label n°5





Light emission



Colour



Mirror

Awards

2010 – Design Innovationen Design Zentrum Nordrhein Westfalen
Reddot Design Award – Product Design Essen (Deutschland)

Materiali: corpo lampada-riflettore in materiale termoplastico; diffusore posteriore in metacrilato opalino.

Specificità: 36 LED RGB producono sul corpo lampada luce decorativa colorata, gestibile attraverso un telecomando.

Materials: body lamp-reflector made of thermoplastic material; back diffuser in opal methacrylate.

Matériaux : corps réflecteur en matériau thermoplastique; diffuseur arrière en méthacrylate opalin.

Materialien: Leuchtenkopf aus thermoplastischem Material; hinterer Schirm aus opalem Methacrylat.

Materiales: cuerpo lámpara-reflector en material termoplástico. Difusor posterior en metacrilato opal.

Specification: 36 RGB LEDs produce decorative coloured light on the body lamp, adjustable using a remote control.

Spécificité : 36 LEDs RGB produisent une lumière colorée sur le corps du luminaire, gérés à l'aide d'une télécommande.

Spezifikation: 36 LED- RGB setzen auf dem Leuchtenkörper Farbakzente, die über eine Fernbedienung steuerbar sind.

Especificaciones: 36 LED RGB producen sobre el cuerpo lámpara luz decorativa colorada, gestionada gracias a un mando a distancia.

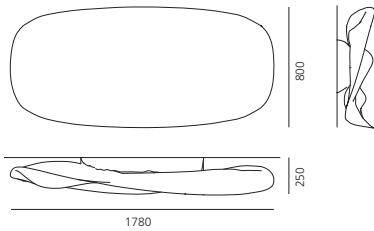

Indirect emission:

FLUO max 2x55W (2G11) – TC-LEL
Lamp included
Dimmable

Decorative light:

36 LED RGB
Total power 7,5W

IP20 EAC

Energy Label n°8



Radiofrequency remote control (included)

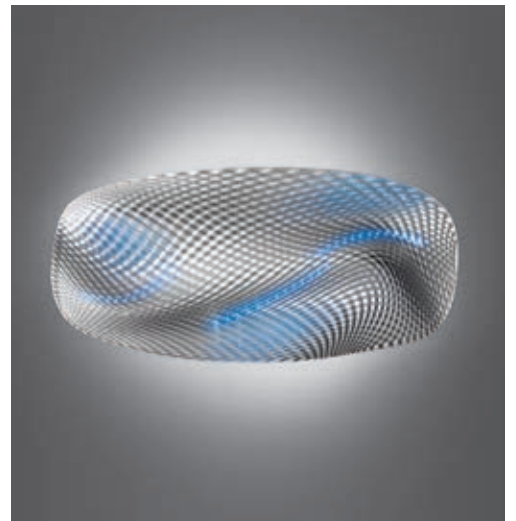
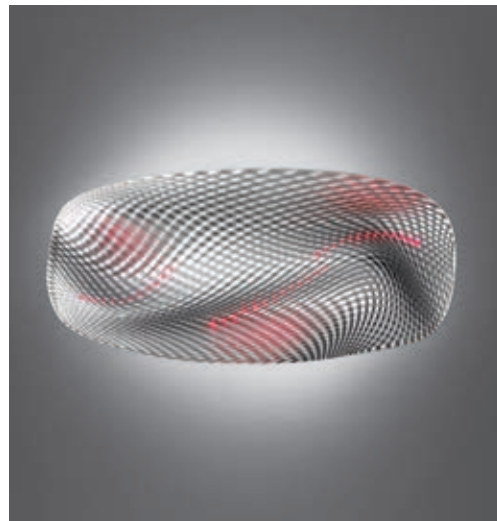
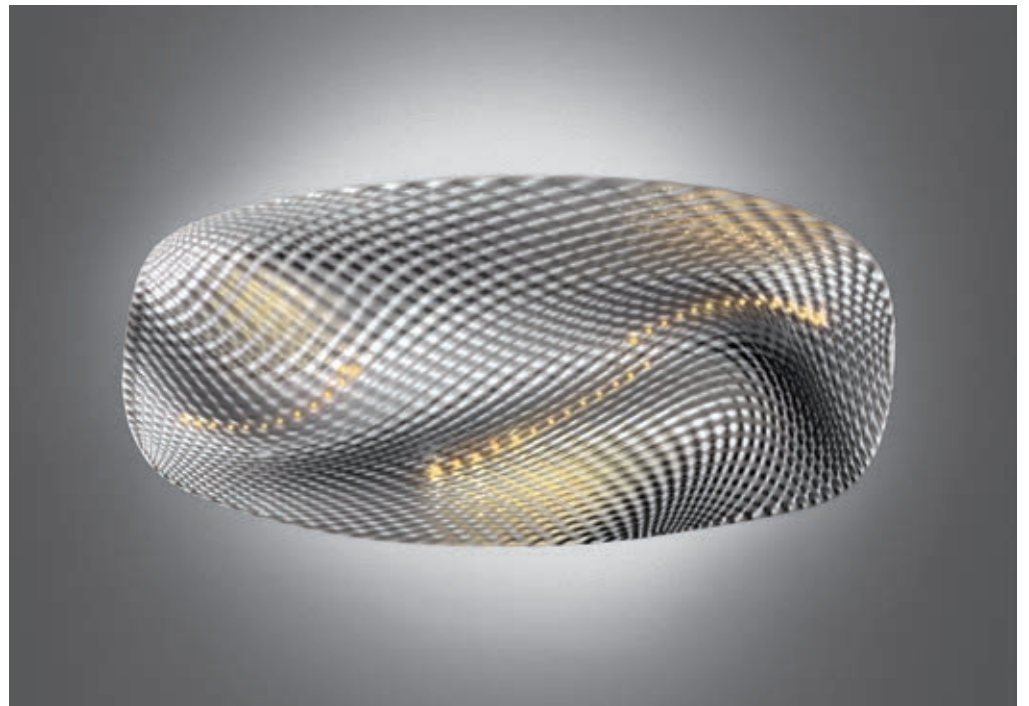

Cosmic Angel soffitto

design

Ross Lovegrove
2009



Light emission



Colour



Mirror

Materiali: corpo lampada-riflettore in materiale termoplastico. Corpi illuminanti in alluminio pressofuso; diffusore superiore in metacrilato opalino.

Materials: body lamp-reflector made of thermo-plastic material; die-cast aluminium lighting units; upper diffuser in opal methacrylate.

Matériaux : corps réflecteur en matériau thermoplastique ; corps lumineux en aluminium moulé sous pression ; diffuseur supérieur en méthacrylate opalin.

Materialien: Leuchtenkopf aus thermoplastischem Material; Leuchtenkörper aus druckgegossenem Aluminium, oberer Schirm aus Opal-Methacrylat.

Materiales: cuerpo lámpara-reflector en material termoplástico. Cuerpos luminosos en aluminio fundido; difusor superior en metacrilato opal.

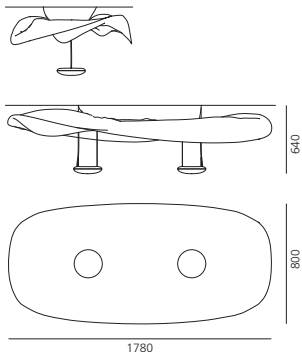

HALO max 2x400W (R7s)
Lamp included
Dimmable
+
FLUO 2x55W (2G11) – TC-LEL
Not dimmable



Energy Label n°21



Light emission



Colour



White

Materiali: struttura in metallo verniciato. Diffusore in metacrilato opalino stampato a iniezione.

Specificità: disponibile in due versioni differenti nella forma: una più sinuosa (Cosmic landscape 30 parete/soffitto) e una più piatta (Cosmic landscape 15 parete/soffitto).

Materials: painted metal structure. Injection-moulded opal methacrylate diffuser.

Matériaux : structure en métal peint. Diffuseur en méthacrylate opalin moulé par injection.

Materialien: Struktur aus lackiertem Metall. Diffusor aus opalem Spritzguss-Methacrylat.

Materiales: estructura de metal pintado. Difusor de metacrilato opalino, moldeado por inyección.

Specification: two different shapes available: Cosmic landscape 30 wall/ceiling is more sinuous, while Cosmic landscape 15 wall/ceiling is flatter.

Spécificité : disponible en deux versions de formes différentes : une plus sinieuse (Cosmic landscape 30 applique-plafonnier) et une plus fine (Cosmic landscape 15 applique-plafonnier).

Spezifikation: Verfügbar in zwei verschiedenen Formen: gewölbt (Cosmic Landscape Wand- / Deckenleuchte 30) oder flach (Cosmic Landscape 15 Wand- / Deckenleuchte).

Especificaciones: está disponible en dos versiones de forma diferente: la primera es más sinuosa (Cosmic landscape applique/plafón 30) y la segunda, más plana (Cosmic landscape 15 aplique/plafón).

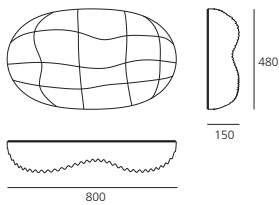

Cosmic Landscape 15 parete/soffitto

FLUO 2x55W (2G11) – TC-LEL
Lamp included
Dimmable



Energy Label n°33

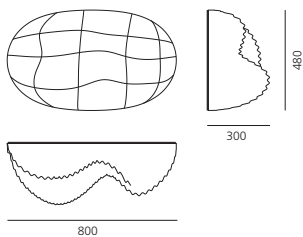

Cosmic Landscape 30 parete/soffitto

FLUO 2x55W (2G11) – TC-LEL
Lamp included
Dimmable



Energy Label n°33

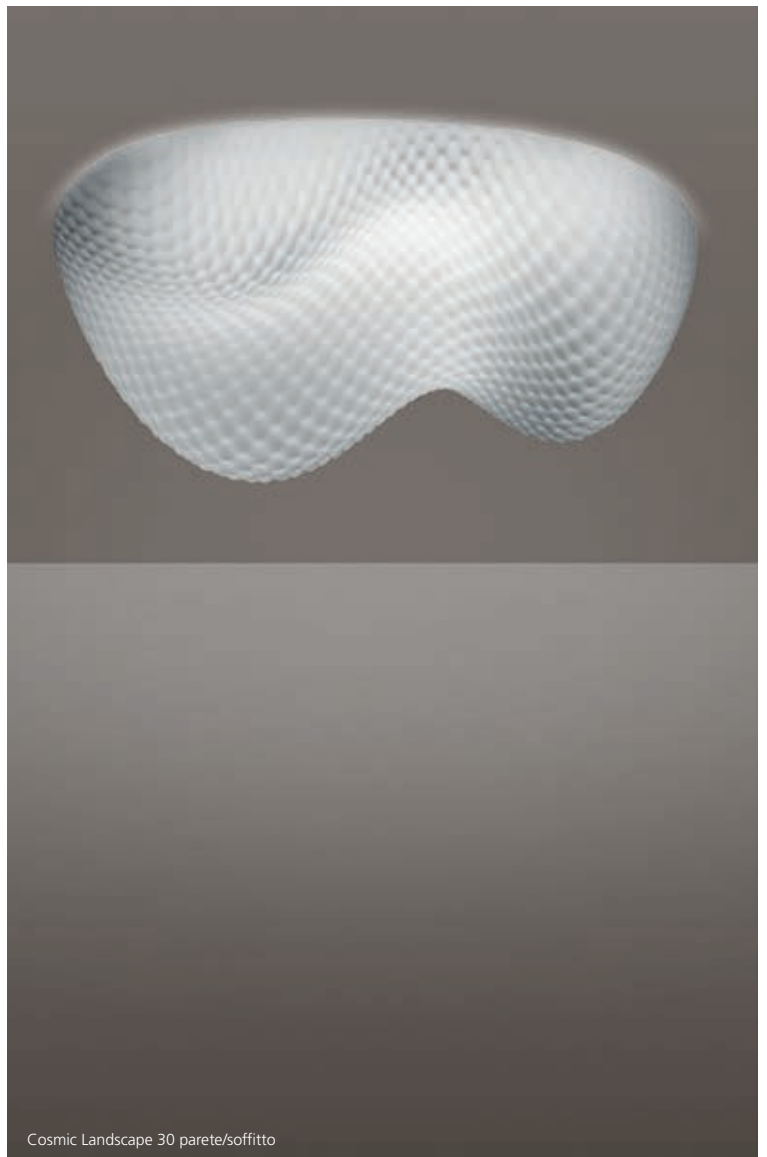

Cosmic Landscape 15 parete/soffitto

Cosmic Landscape 30 parete/soffitto

Light emission



Colour



White

Materiali: struttura in metallo verniciato. Diffusore in metacrilato opalino stampato a iniezione.

Awards

Design Innovationen Design Zentrum
Nordrhein Westfalen
2010 – Reddot Design Award – Product Design
Essen (Deutschland)

Materials: painted metal
structure. Injection-moulded
opal methacrylate diffuser.

Matériaux : structure
en métal peint. Diffuseur
en méthacrylate opalin
moulé par injection.

Materialien: Struktur
aus lackiertem Metall.
Diffusor aus opalem
Spritzguss-Methacrylat.

Materiales: estructura
de metal pintado. Difusor
de metacrilato opalino,
moldeado por inyección.

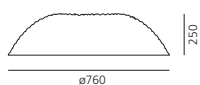
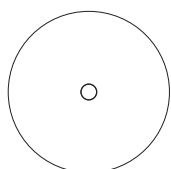

FLUO 2x55W (G11) – TC-TEL
Lamp included
With electronic ballast
Dimmable DALI



Energy Label n°33



Edge 21 parete/soffitto
Edge 30 parete/soffitto

design

Alessandro Mendini
2004



381



Light emission



Colour



White

Materiali: supporto parete in resina termoplastica; diffusore in materiale termoplastico.

Specificità: il grado di protezione IP65 la rende idonea all'utilizzo anche in esterno.

Materials: wall support in thermoplastic resin; diffuser in thermoplastic material.

Matériaux : support applique en résine thermoplastique; diffuseur en matériau thermoplastique.

Materialien: Wandhalterung aus Kunstharz; Schirm aus thermoplastischem Material.

Materiales: soporte aplique de resina termoplástica; difusor en material termoplástico.

Specification: IP65 rating makes it suitable also for outdoor use.

Spécificité : l'indice de protection IP65 permet l'installation de l'appareil en extérieur.

Spezifikation: Durch Schutzart IP65 auch im Außenbereich einsetzbar.

Especificaciones: el grado de protección IP65 la hace idónea para exteriores.

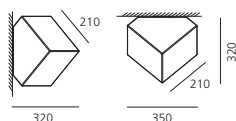

Edge 21 parete/soffitto

FLUO 1x20W (E27) – TC-TSE
Not dimmable

IP65  

Energy Label n°9

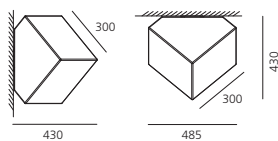

Edge 30 parete/soffitto

FLUO 1x23W (E27) – TC-TSE
Not dimmable

IP65  

Energy Label n°9





Groupage 20
Groupage 32
Groupage 45

design

Ernesto Gismondi,
Daniele Moioli
2014



Light emission



Colours



White



Orange

Lampada a soffitto disponibile come elemento singolo o in più unità componibili.

Materiali: corpo lampada in alluminio con finitura verniciata; attacco a soffitto in acciaio; schermo diffusore in metacrilato diffondente.

Specificità: un unico punto luce permette di alimentare, tramite una connessione elettrica, più elementi, garantendo un'ampia libertà di installazione.

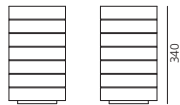

Groupage 20

LED Total power 13W
Color temperature 3000K
Lighting output 491lm
Dimmable



Energy Label n°1

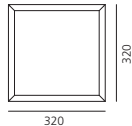

Groupage 32

LED Total power 23W
Color temperature 3000K
Lighting output 1451lm
Dimmable



Energy Label n°1

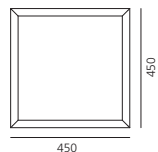

Groupage 45

LED Total power 40W
Color temperature 3000K
Lighting output 3036lm
Dimmable



Energy Label n°1

Ceiling lamp available as a stand-alone element or as a configuration of multiple modular units.

Materials: painted aluminium body; steel ceiling plate; methacrylate diffusing screen.

Specifications: a single power source is able to feed multiple elements via a mains connection, allowing a wide variety of installation options.

Plafonnier disponible en tant qu'élément unitaire ou en éléments pouvant être regroupés.

Matériaux : corps en aluminium verni ; support mural en acier ; écran diffuseur en méthacrylate diffusant.

Spécificités : un seul point de lumière qui permet d'alimenter par le biais d'une connexion électrique plusieurs éléments, garantissant ainsi une grande liberté d'installation.

Deckenleuchte erhältlich als einzelnes Element oder in mehreren modularen Einheiten.

Materialien: Körper aus lackiertem Aluminium; Deckenmontage aus Stahl; Schirm aus streuendem Methacrylat.

Spezifikation: Eine einzige Lichtquelle versorgt mehrere Elemente über eine elektrische Verbindung und bietet somit reichlich gestalterische Flexibilität.

Lámpara de techo disponible como un elemento independiente o en múltiples unidades modulares.

Materiales: el cuerpo compuesto de aluminio pintado; conexión de techo de acero; pantalla difusor de metacrilato.

Especificaciones: un único punto de luz permite alimentar, gracias a una conexión eléctrica, más elementos, garantizado una amplia libertad de instalación.

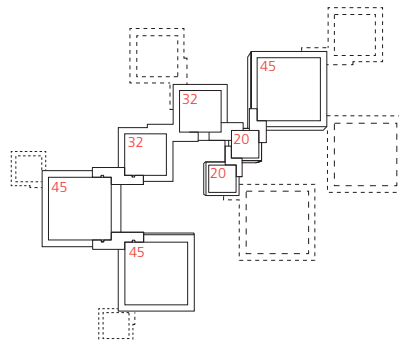

01
20-20

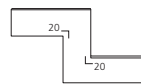

02
20-32
20-45

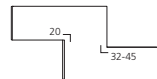

03
32-32
32-45
45-45

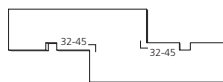



Float circolare soffitto
Float lineare soffitto

design

James Irvine
2000



370

Light emission



Colour



White

Materiali: struttura in alluminio verniciato; diffusore inferiore in metacrilato opalino; diffusore superiore in policarbonato trasparente.
Specificità: disponibile nelle versioni circolare o lineare.
È possibile applicare un filtro blu o topazio all'emissione indiretta (solo nella versione circolare).

Materials: structure in painted aluminium, lower diffuser in opaline methacrylate, upper diffuser in transparent polycarbonate.

Matériaux : structure en aluminium verni ; diffuseur inférieur en méthacrylate opalin ; diffuseur supérieur en polycarbonate transparent.

Materialien: Struktur aus lackiertem Aluminium; unterer Schirm aus opalem Methacrylat; oberer Schirm aus transparentem Polycarbonat.

Materiales: estructura de aluminio pintado. Difusor inferior de metacrilato opalino, difusor superior en policarbonato transparente.

Specification: available in circular or linear versions. A coloured filter, blue or topaz, may be fixed to the indirect light emission (available on Float circolare only).

Spécificité : disponible en version circulaire ou linéaire. Un filtre coloré (bleu ou topaze) peut être ajouté, à l'émission indirecte (seulement pour Float circulaire).

Spezifikation: Erhältlich als Kreis- oder Linearausführung. Für die Versione Float circolare ist der Einsatz eines blauen oder goldgelben Farbfilters möglich.

Especificaciones: disponible en dos versiones: linear o circular. Es posible aplicar un filtro azul o topacio para la emisión de luz indirecta (sólo en la versión circular).

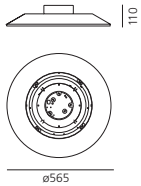

Float circolare soffitto

FLUO 1x55W (2GX13) – T16-R
Lamp included
With electronic ballast
Not dimmable



Energy Label n°28

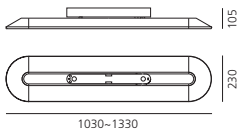

Float lineare soffitto

FLUO 2x39W (G5) – T16
Lamp included
Not dimmable



Energy Label n°23

FLUO 2x54W (G5) – T16
Lamp included
With electronic ballast
Not dimmable



Energy Label n°23



Coloured filter for Float circolare only



Coloured filter for Float circolare only



Pirce soffitto
Pirce mini soffitto

Design
Giuseppe Maurizio Scutellà
2012



Light emission



Colour



Polished
white



Black
(only LED)



Gold
(only LED)

Materiali: alluminio verniciato. Da un disco sottile si aprono volute fluttuanti, che ricadono morbidamente verso il basso, creando magici effetti di forma e luce.

Materials: painted aluminium. From a thin ceiling plate, gently descending waving spirals create enchanting effects of form and light.

Matériaux : aluminium verni. Un disque mince donne naissance à des volutes flottantes qui retombent doucement vers le bas en créant des effets magiques de formes et de lumière.

Materialien: Lackiertes Aluminium. Eine feine Scheibe geht in sanft geschwungene Spiralen über, die sich nach unten neigen und magische Lichteffekte erzeugen.

Materiales: aluminio pintado. De un disco fino parten espirales fluctuantes que caen suavemente hacia abajo, creando mágicos efectos de forma y luz.

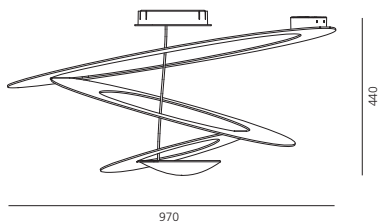
**Pirce soffitto LED**

LED Total power 44W
Color temperature 3000K
Lighting output 3344lm
Dimmable

IP20

Energy Label n°1

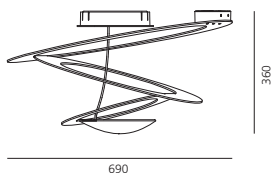
**Pirce mini soffitto LED**

LED Total power 44W
Color temperature 3000K
Lighting output 3344m
Dimmable

IP20

Energy Label n°1

Pirce soffitto Halo

HALO max 1x330W (R7s)
Lamp included
Dimmable

IP20

Energy Label n°29

Pirce mini soffitto Halo

HALO max 1x330W (R7s)
Lamp included
Dimmable

IP20

Energy Label n°29



Pirce mini soffitto

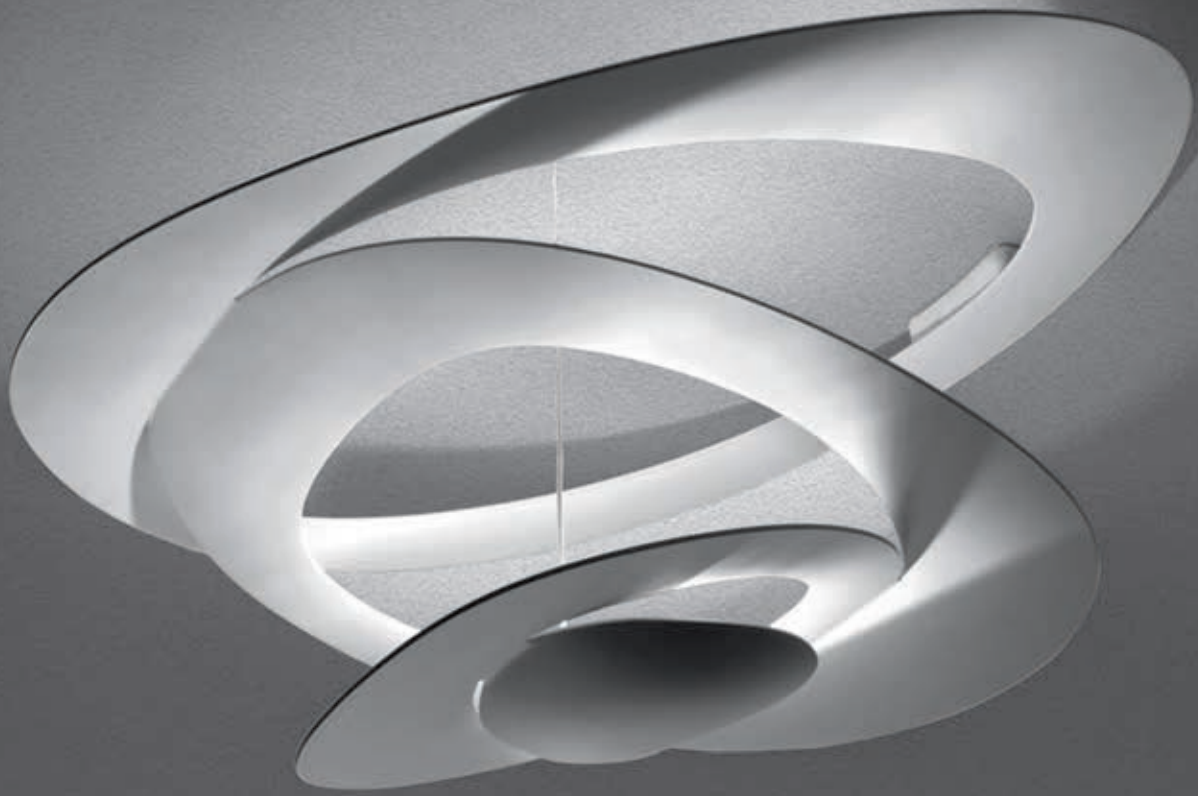

Led Net line 66 soffitto
Led Net line 125 soffitto

design

Michele De Lucchi
Alberto Nason
2011



342

Light emission



Colour



White

Materiali: struttura in alluminio verniciato. Ogni LED è dotato di lente in metacrilato trasparente e di porta-lente in metacrilato satinato.
Specificità: grazie al ridotto cono di emissione (70°), Led Net line è anche adatto per uffici, dove è richiesto il controllo dell'abbagliamento.

Materials: painted aluminium structure. Each LED is fitted with a transparent methacrylate lens and a satin finish methacrylate lens-holder.

Matériaux : structure en aluminium peint. Chaque LED est munie d'une lentille en méthacrylate transparent et d'un porte-lentille en méthacrylate satiné.

Materialien: Struktur aus lackiertem Aluminium. Alle LEDs mit Linse aus transparentem Methacrylat und Linsenträger aus mattem Methacrylat.

Materiales: estructura de aluminio pintado. Cada LED consta de lente de metacrilato transparente y de porta-lente de metacrilato satinado.

Specification: thanks to its reduced angular emission cone (70°), Led Net line is also suitable for offices, where glare control is needed.

Spécificité : grâce au réduit cône d'émission (70°), Led Net line est également adapté pour les bureaux, où le contrôle d'éblouissement est nécessaire.

Spezifikation: Dank des kleinen Abstrahlwinkels (70°), ist Led Net line auch für Büros geeignet, in denen ein Blendschutz erforderlich ist.

Especificaciones: gracias al cono de emisión reducida (70°), Led Net line es también apto para oficinas, donde se requiere el control del deslumbramiento.

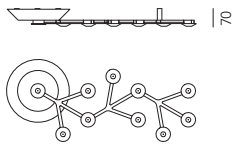

660

Led Net line 66 soffitto

9 LED Total power 23W
Color temperature 3000K
Lighting output 1313lm
Not dimmable



Energy Label n°1

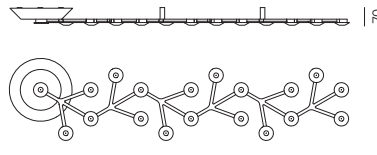

1250

Led Net line 125 soffitto

18 LED Total power 45W
Color temperature 3000K
Lighting output 2530lm
Dimmable



Energy Label n°1

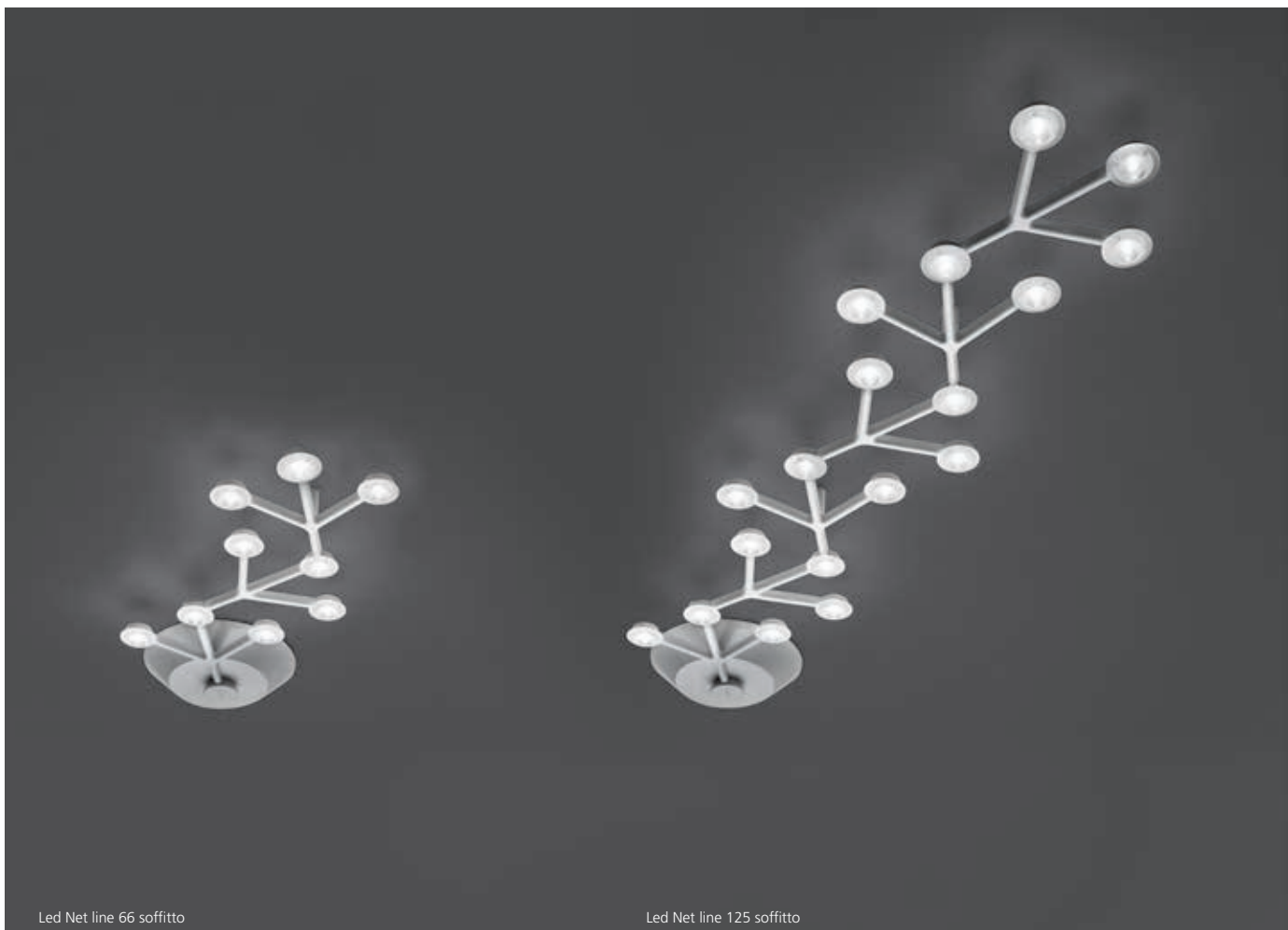

Led Net line 66 soffitto

Led Net line 125 soffitto

Led Net circle soffitto

design

Michele De Lucchi
Alberto Nason
2011



344

Light emission



Colour



White

Materiali: struttura in alluminio verniciato. Ogni LED è dotato di lente in metacrilato trasparente e di porta-lente in metacrilato satinato.
Specificità: grazie al ridotto cono di emissione (70°), Led Net circle è anche adatto per uffici, dove è richiesto il controllo dell'abbagliamento.

Materials: painted aluminium structure. Each LED is fitted with a transparent methacrylate lens and a satin finish methacrylate lens-holder.

Matériaux: structure en aluminium peint. Chaque LED est munie d'une lentille en méthacrylate transparent et d'un porte-lentille en méthacrylate satiné.

Materialien: Struktur aus lackiertem Aluminium. Alle LED mit Linse aus transparentem Metacrylat und Linsenträger aus mattem Metacrylat.

Materiales: estructura de aluminio pintado. Cada LED consta de lente de metacrilato transparente y de porta-lente de metacrilato satinado.

Specification: thanks to its reduced angular emission cone (70°), Led Net circle is also suitable for offices, where glare control is needed.

Spécificité : grâce au réduit cône d'émission (70°), Led Net circle est également adapté pour les bureaux, où le contrôle d'éblouissement est nécessaire.

Spezifikation: Dank des kleinen Abstrahlwinkels (70°), ist Led Net circle auch für Büros geeignet, in denen ein Blendschutz erforderlich ist.

Especificaciones: gracias al cono de emisión reducida (70°), Led Net circle es también apto para oficinas, donde se requiere el control del deslumbramiento.

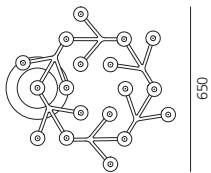

18 LED Total power 43W
Color temperature 3000K
Lighting output 2502lm
Dimmable



Energy Label n°1



Led Net circle soffitto





Iosif

design

MiloDaMalo
2014

Light emission



Colours



Red

Lampada dedicata alla luce puntuale per gli ambienti, oltre a essere un elemento grafico nello spazio.

Materiali: alluminio verniciato.

Specificità: un cilindro leggerissimo fissato al soffitto, racchiude all'estremità inferiore una sorgente LED regolata da apposite lenti che controllano il fascio di emissione garantendo una luce puntuale e allo stesso tempo morbida.

Iosif is an indoor light fitting producing accent lighting, as well as being a graphic element in space.

Materials: painted aluminium.

Specification: a ceiling-mounted, ultra-light painted aluminium cylinder with an LED source at its lower end, which is controlled by special lenses adjusting the light emission and ensuring a focused, soft beam.

Iosif est une lampe dédiée à la lumière ponctuelle, en plus d'être un élément graphique dans l'espace.

Matériaux : aluminium verni.

Spécificités : c'est un cylindre très léger fixé au plafond qui contient à l'extrémité inférieure une source LED réglée par le biais de lentilles spéciales gérant le faisceau d'émission et garantissant ainsi une lumière ponctuelle et douce.

Eine Leuchte, die als fokussierter Punktstrahler und grafisches Element im Raum gleichermaßen fungiert.

Materialien: lackiertes Aluminium

Spezifikation: Ein ultraleichter Zylinder zur Montage an der Decke umschließt am unteren Ende eine LED-Lichtquelle. Die speziellen Linsen gewährleisten fokussiertes und dennoch weiches Licht.

Lámpara de luz puntual para los distintos ambientes, así como un elemento gráfico en el espacio.

Materiales: aluminio pintado.

Especificaciones: un cilindro de aluminio pintado ultraligero sujeto al techo encierra una fuente LED en su extremo inferior, controlado por lentes especiales que actúan sobre la emisión, asegurando una luz concentrada pero suave al mismo tiempo.



○
—
Ø30

LED Total power 5W
Color temperature 3000K
Lighting output 180lm
Not dimmable

IP20 EAC

Energy Label n°1





Nur soffitto
Nur mini soffitto

design
Ernesto Gismondi
2007



362

Light emission



Colours



Anodized



Anthracite Grey

Materiali: corpo lampada in alluminio; diffusore in policarbonato.
Specificità: all'emissione diretta si aggiunge un'emissione indiretta che produce un alone di luce decorativo sul soffitto.

Materials: aluminium body lamp; polycarbonate diffuser.

Matériaux : corps en aluminium ; diffuseur en polycarbonate.

Materialien: Leuchtenkörper aus Aluminium; Schirm aus Polycarbonat.

Materiales: cuerpo de la lámpara en aluminio; difusor en policarbonato.

Specification: in addition to the direct emission, an indirect emission creates a halo of decorative light on the ceiling.

Spécificité : l'émission directe s'enrichit d'une émission indirecte qui produit un halo lumineux décoratif au plafond.

Spezifikation: der direkte Lichtaustritt wird durch indirektes Licht ergänzt, das an der Zimmerdecke einen dekorativen Lichtkranz entstehen lässt.

Especificaciones: a la emisión de luz directa se suma la indirecta, para dar vida a un halo de luz decorativo sobre el techo.

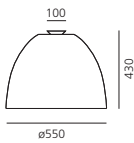
**NUR soffitto LED**

LED Total power 45W
Color temperature 2700K
Lighting output 2457lm
Dimmable

IP40

Energy Label n°1

Nur soffitto Halo

HALO max 1x205W (E27)
Dimmable

IP40

Energy Label n°6

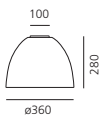
**NUR mini soffitto LED**

LED Total power 30W
Color temperature 2700K
Lighting output 1396lm
Dimmable

IP40

Energy Label n°1

Nur mini soffitto Halo

HALO max 1x150W (E27)
Dimmable

IP40

Energy Label n°6



Nur soffitto anodized

Nur mini soffitto anthracite grey



Nur gloss soffitto
Nur gloss mini soffitto

design
Ernesto Gismondi
2009



366

Light emission



Colours



Polished Black



Polished White

Materiali: corpo lampada in alluminio verniciato; diffusore in policarbonato.
Specificità: una finitura perfettamente liscia e lucida conferisce eleganza al classico modello Nur. All'emissione diretta si aggiunge un'emissione indiretta che produce un alone di luce decorativo sul soffitto.

Materials: painted aluminium body lamp; polycarbonate diffuser.

Matériaux : corps en aluminium verni; diffuseur en polycarbonate.

Materialien: Körper aus lackiertem Aluminium; Schirm aus Polycarbonat.

Materiales: cuerpo de aluminio pintado; difusor en policarbonato.

Specification: a perfectly smooth and polished finish adding that extra touch of elegance to the classic Nur model. In addition to the direct emission, an indirect emission creates a halo of decorative light on the ceiling.

Spécificité : une finition parfaitement lisse et brillante donne plus d'élégance au modèle Nur classique. L'émission directe s'enrichit d'une émission indirecte qui produit un halo lumineux décoratif au plafond.

Spezifikation: Die Hochglanzpolitur verleiht dem Klassiker Nur eine besondere Eleganz. Der direkte Lichtaustritt wird durch indirektes Licht ergänzt, das an der Zimmerdecke einen dekorativen Lichtkranz entstehen lässt.

Especificaciones: un acabado perfectamente liso y brillante confiere elegancia al clásico modelo Nur. A la emisión de luz directa se suma la indirecta, para dar vida a un halo de luz decorativo sobre el techo.

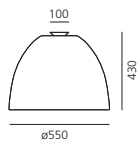

Nur gloss soffitto LED

LED Total power 45W
Color temperature 2700K
Lighting output 2457lm
Dimmable

IP40 ENEC

Energy Label n°1

Nur gloss soffitto Halo

HALO max 1x205W (E27)
Dimmable

IP40 ENEC

Energy Label n°6

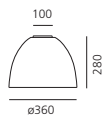

NUR gloss mini soffitto LED

LED Total power 30W
Color temperature 2700K
Lighting output 1396lm
Dimmable

IP40 ENEC

Energy Label n°1

Nur gloss mini soffitto Halo

HALO max 1x150W (E27)
Dimmable

IP40 ENEC

Energy Label n°6



Nur gloss soffitto polished black

Nur gloss mini soffitto polished white



Skydro

design

Ross Lovegrove
2008, 2012

Light emission



Colour



Mirror

Materiali: corpi riflettenti in ABS stampato ad iniezione; corpo illuminante in pressofusione di alluminio; struttura portante in acciaio verniciato.

Specificità: Skydro è disponibile con o senza corpo illuminante integrato e nelle versioni con sorgente alogena e LED.

Grazie alla componibilità del sistema, aggregando più unità di uno stesso modulo si possono ottenere un numero elevatissimo di configurazioni.

Per il montaggio di configurazioni multiple, è necessario, oltre al modulo base (con o senza sorgente luminosa), un kit di montaggio (dima) ed i kit cavi per il collegamento elettrico.

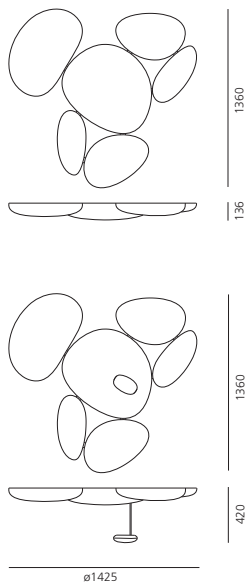

Materials: ABS injection-moulded reflective units; lighting unit in die cast aluminium; painted steel load-bearing structure.

Matériaux : unités réfléchissantes en ABS moulé, unité d'éclairage en fonte d'aluminium, structure porteuse en acier peint.

Materialien: Reflektierende Körper aus Spritzguss thermoplast; Reflektor aus formgestanztem Aluminium; Struktur aus lackiertem Stahl.

Materiales: cuerpo reflexivo en ABS estampado a inyección, cuerpo luminoso en presofusión de aluminio, estructura portante en acero pintado.

Specification: Skydro is available with or without integrated lighting unit; in halogen or LED.

Thanks to the modularity of the system, several configurations can be created simply adding additional units. To assemble additional units, in addition to the basic modules (with or without light source) an assembly kit (template) and cable kits for the electrical connection are required.

Spécificité: Skydro est disponible avec ou sans source lumineuse, en version halogènes ou LED. Compte tenu de la modularité du système, il est possible d'obtenir de nombreuses configurations, en ajoutant simplement des éléments. Pour l'installation d'unités multiples, un kit d'assemblage est nécessaire (gabarit), des kits de câblage pour la connexion électrique, ainsi que des unités de base (avec ou sans source lumineuse).

Spezifikation: Skydro ist mit integriertem oder externem Strahler erhältlich. Wahlweise mit Halogen- oder LED. Die modulare Struktur ermöglicht die Kombination mehrerer Skydro-Elemente. Hierdurch entstehen beliebig große Konfigurationen. Zur Verkabelung mehrerer Einheiten ist ein elektronischer Verbinder sowie ein Montage-Kit erforderlich.

Especificaciones: Skydro está disponible en dos versiones: con o sin cuerpo luminoso integrado. Gracias a la composición del sistema, agregando los módulos se pueden obtener numerosas configuraciones. Para el montaje de configuraciones múltiples son necesarios- más allá de los módulos base (con o sin fuente de luz- un kit de montaje - dima - y un kit de cables para la conexión eléctrica).

Skydro LED

LED Total power 29W
Color temperature 3000K
Lighting output 2330lm
Dimmable



Energy Label n°1

Skydro Halo

HALO max 1x160W (R7s)
Lamp included
Dimmable



Energy Label n°5



Kilina Hotel, Milan (IT)

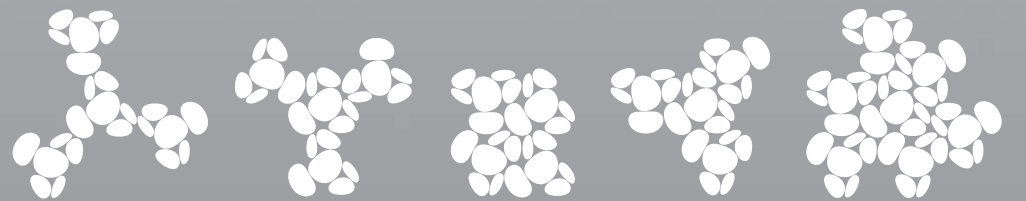
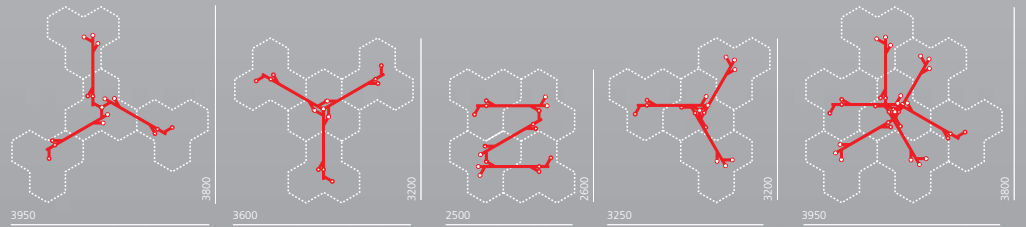

Light emission



Colours



Materiali: supporto soffitto in alluminio pressofuso, corpo in alluminio stampato e trattato a specchio, diffusore in materiale termoplastico stampato ad iniezione.

Materials: de-cast aluminium ceiling plate, body in moulded aluminium with mirror finish, diffuser in injection-moulded thermoplastic material.

Matériaux : support plafonnier et corps en aluminium moulé sous pression ; diffuseur en matériau thermoplastique traité façon miroir.

Materialien: Deckenbaldachin aus Aluminiumdruckguss, Körper aus Aluminium-Spritzguss und hochglanzpoliertem Aluminium, Schirm aus thermoplastischem Material, in Spritzgusstechnik hergestellt.

Materiales: soporte de plafón en aluminio fundido a presión, cuerpo de aluminio moldeado por inyección y con acabado pulido espejo; difusor de material termoplástico estampado a inyección.

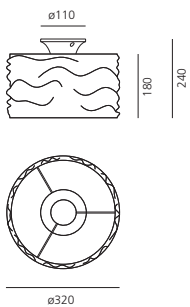

HALO max 1x150W (E27)
Dimmable



Energy Label n°4



Droplet soffitto

design

Ross Lovegrove
2007, 2011

Light emission



Colours



Materiali: corpi luminosi in alluminio pressofuso; riflettore in alluminio stampato e verniciato.

Materials: die-cast aluminium lighting units; painted die-cast aluminium reflector.

Matériaux : corps lumineux en aluminium moulé sous pression. Réflecteur en aluminium moulé et verni.

Materialien: Leuchtenkörper aus druckgegossenem Aluminium; Reflektor aus formgestanztem Aluminium.

Materiales: cuerpos luminosos en aluminio fundido a presión; reflector en aluminio moldeado y pintado.

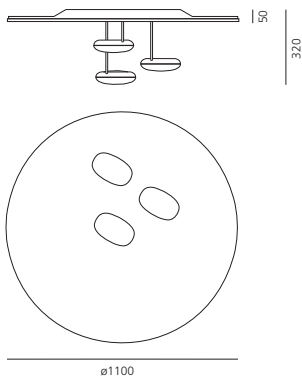
**Droplet soffitto LED**

LED Total power 3x29W
Color temperature 3000K
Lighting output 3x2330lm
Dimmable



Energy Label n°1

Droplet soffitto halo

HALO max 3x160W (R7s)
Lamp included
Dimmable



Energy Label n°5



Mercury soffitto Mercury mini soffitto

design

Ross Lovegrove
2007, 2011



390

Light emission



Colours



Awards

Mercury soffitto
2008 – Good Design Award
The Chicago Athenaeum, Chicago (US)

Materiali: corpi luminosi in alluminio pressofuso; corpi riflettenti in materiale termoplastico stampato ad iniezione con finitura metallizzata; riflettore in acciaio inox.

Materials: die-cast aluminium lighting units; reflective units made of injection-moulded thermoplastic material with metallic finish; stainless steel reflector.

Matériaux : corps en aluminium moulé sous pression; galets réfléchissants en matériau thermoplastique finition métallisée ; réflecteur en acier inoxydable.

Materialien: Leuchtenkörper aus druckgegossenem Aluminium; reflektierende Körper aus Spritzguss-Thermoplast mit Metallic-Oberfläche, Reflektor aus Edelstahl.

Materiales: Cuerpos luminosos en aluminio fundido a presión; cuerpos reflectantes en material termoplástico moldeado por inyección, con acabado metalizado; reflector en acero inoxidable.

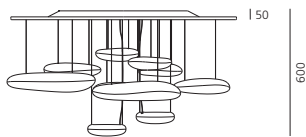

Mercury soffitto LED

LED Total power 2x29W
Color temperature 3000K
Lighting output 2x2330lm
Dimmable



Energy Label n°1

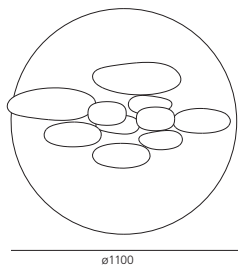

Mercury soffitto Halo

HALO max 2x160W (R7s)
Lamp included
Dimmable



Energy Label n°5

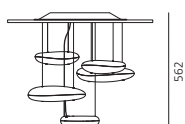

Mercury mini soffitto LED

LED Total power 29W
Color temperature 3000K
Lighting output 2330lm
Dimmable



Energy Label n°1

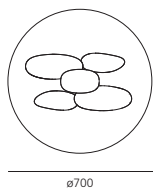

Mercury mini soffitto Halo

HALO 1x160W (R7s)
Lamp included
Dimmable



Energy Label n°5

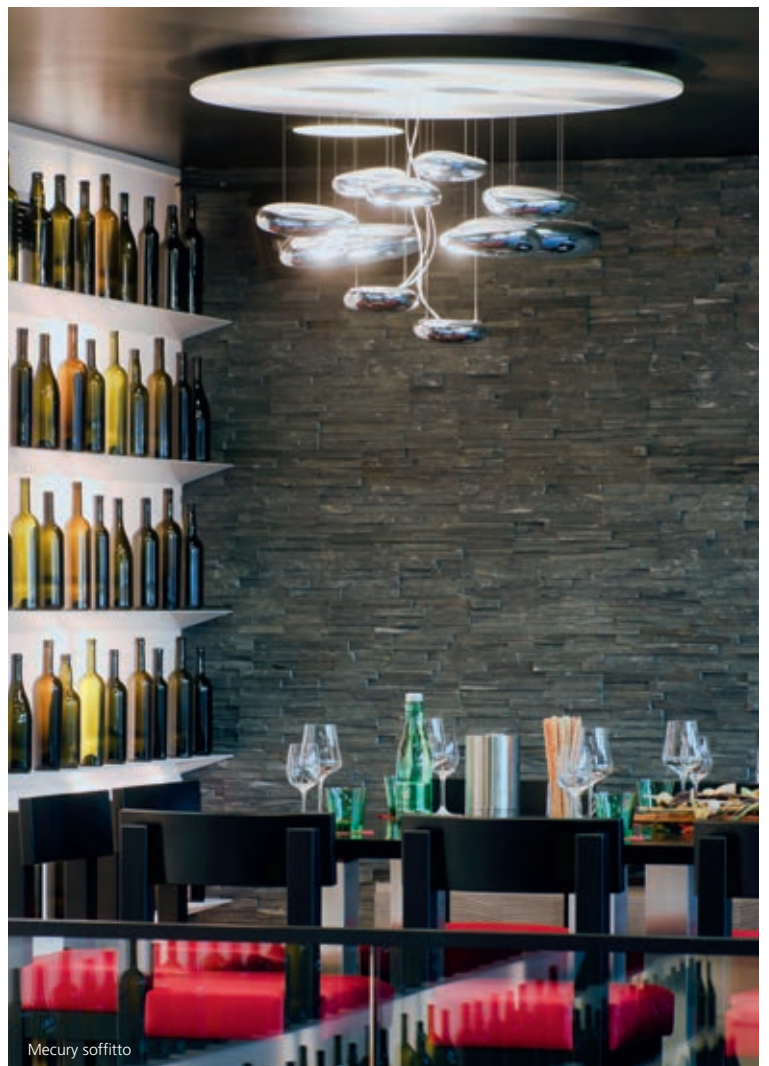

Mercury soffitto



Cosmic Leaf soffitto

design

Ross Lovegrove
2009

191

Light emission



Colours

Diffuser:
TransparentLighting unit:
Grey

Awards

2009 – Reddot Design Award
Product Design
Essen (Deutschland)

Materiali: struttura in acciaio cromato; corpo lampada-diffusore in metacrilato trasparente texturizzato; corpo illuminante in metallo verniciato.

Materials: chromed steel structure; body lamp-diffuser in transparent methacrylate with texture; painted metal lighting unit.

Matériaux : structure en acier chromé ; corps diffuseur en méthacrylate transparent tissé ; corps lumineux en métal peint.

Materialien: Gestell aus verchromten Stahl, Leuchtenkörper aus transparentem, strukturiertem Methacrylat; Beleuchtungseinheit aus lackiertem Metall.

Materiales: estructura en metal cromado; cuerpo de la lámpara-difusor en metacrilato transparente texturizado, cuerpo luminoso en metal pintado.

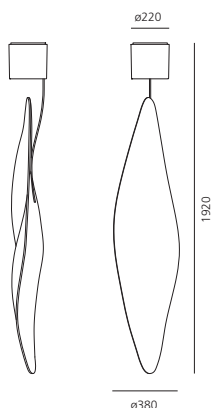

Cosmic Leaf soffitto LED

LED Total power 22W
Color temperature 3000K
Lighting output 1500lm
Dimmable

IP20  EAC

Energy Label n°1

Cosmic Leaf soffitto Halo

HALO 1x100W (G53) - QR 111
Lamp included
Dimmable

IP20  EAC

Energy Label n°32

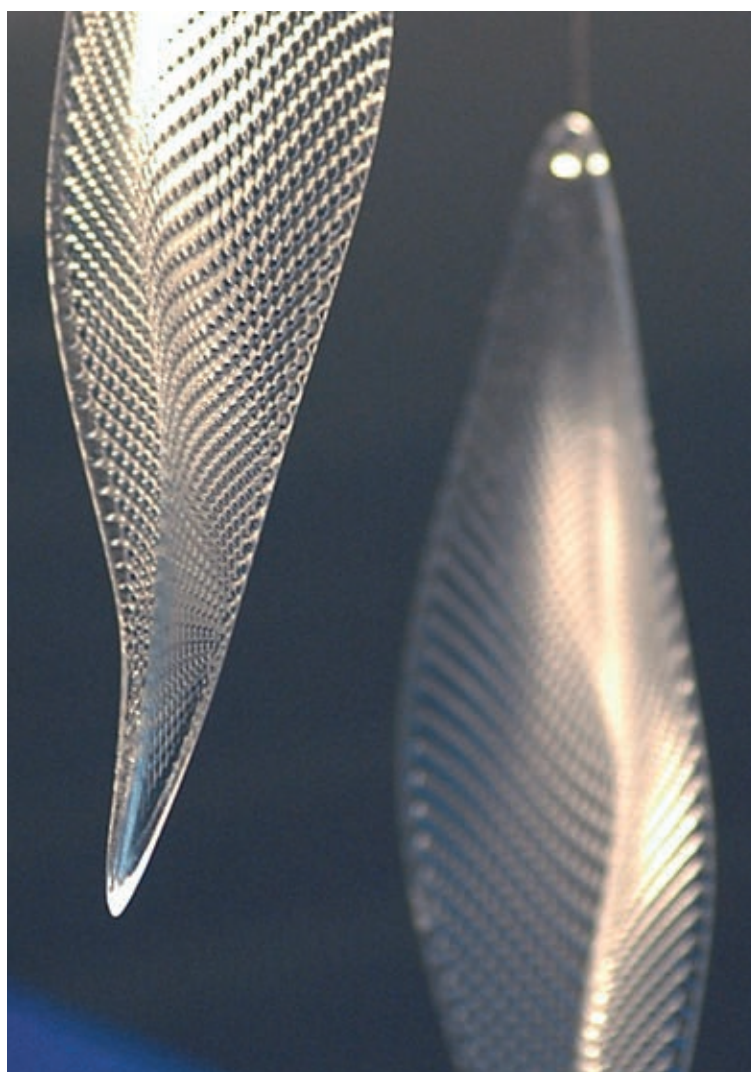



Botanic rain

design

Ross Lovegrove
2012

Light emission



Colours

Hang elements:
polished whiteHang elements:
metal Grey

“Botanic rain usa un sofisticato polimero cristallino per rifrangere e riflettere la luce attraverso un modulo a forma di foglia ispirato alla botanica che è lasciato sospeso, in modo da creare un sistema polimerico a facciata continua”.

Materiali: profilo illuminante in alluminio. Elementi a cascata in materiale termoplastico stampato a iniezione. Il profilo è disponibile a incasso o a soffitto e in diverse lunghezze.

“Botanic rain is made of an advanced crystal polymer able to refract and reflect light. Its suspended leaf modules, inspired by botanic shapes, create a polymer curtain wall system”.

« Botanic rain utilise un polymère cristallin sophistiqué pour réfracter et réfléchir la lumière à travers un module en forme de feuille, emprunté à la botanique et restant suspendu, de manière à créer un système polymérique à facettes continues ».

„ Abgependelte Module, deren blattförmiges Design von der Botanik inspiriert wurde, bilden einen attraktiven Vorhang aus Kristallpolymeren, die das Licht brechen und reflektieren.“

“Botanic rain emplea un polimero cristalino para refractar y reflejar la luz a través de un módulo con forma de hoja, de inspiración vegetal. Al colgarlo, se crea un sistema polimérico que da vida a una fachada cortina”.

Materials: aluminium lighting profile. Suspended elements made of injection-moulded thermoplastic material. The profile is available recessed or ceiling-mounted and with different lengths.

Matériaux : profilé éclairant en aluminium. Éléments à cascade en matériau thermoplastique moulée par injection. Le profilé est disponible en version encastrable et en différentes longueurs.

Materialien: Leuchtprofil aus Aluminium. Kaskadenelemente aus spritzgegossenem thermoplastischem Material. Das Profil ist als Einbau- oder Deckenversion in verschiedenen Längen lieferbar.

Materiales: perfil luminoso de aluminio; elementos en cascada de material termoplástico moldeado por inyección. El perfil está disponible para empotrar o como plafón y viene en varios largos diferentes.

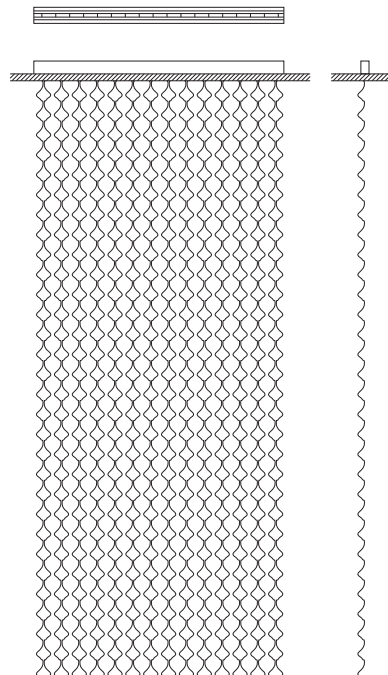
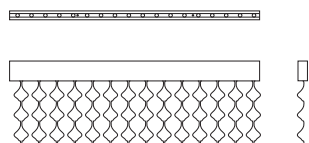
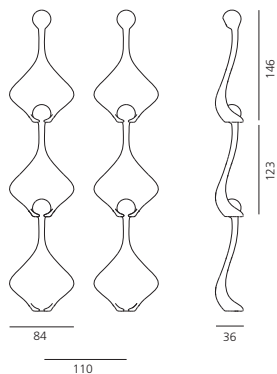

Only for custom projects which feasibility must be approved by Artemide technical design department

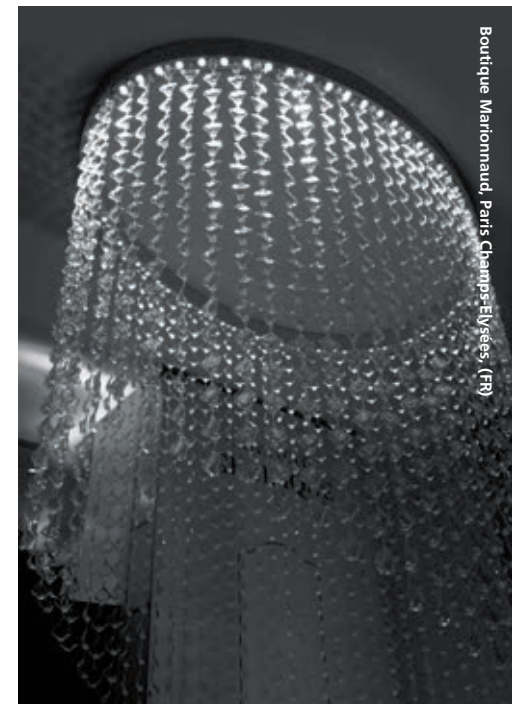

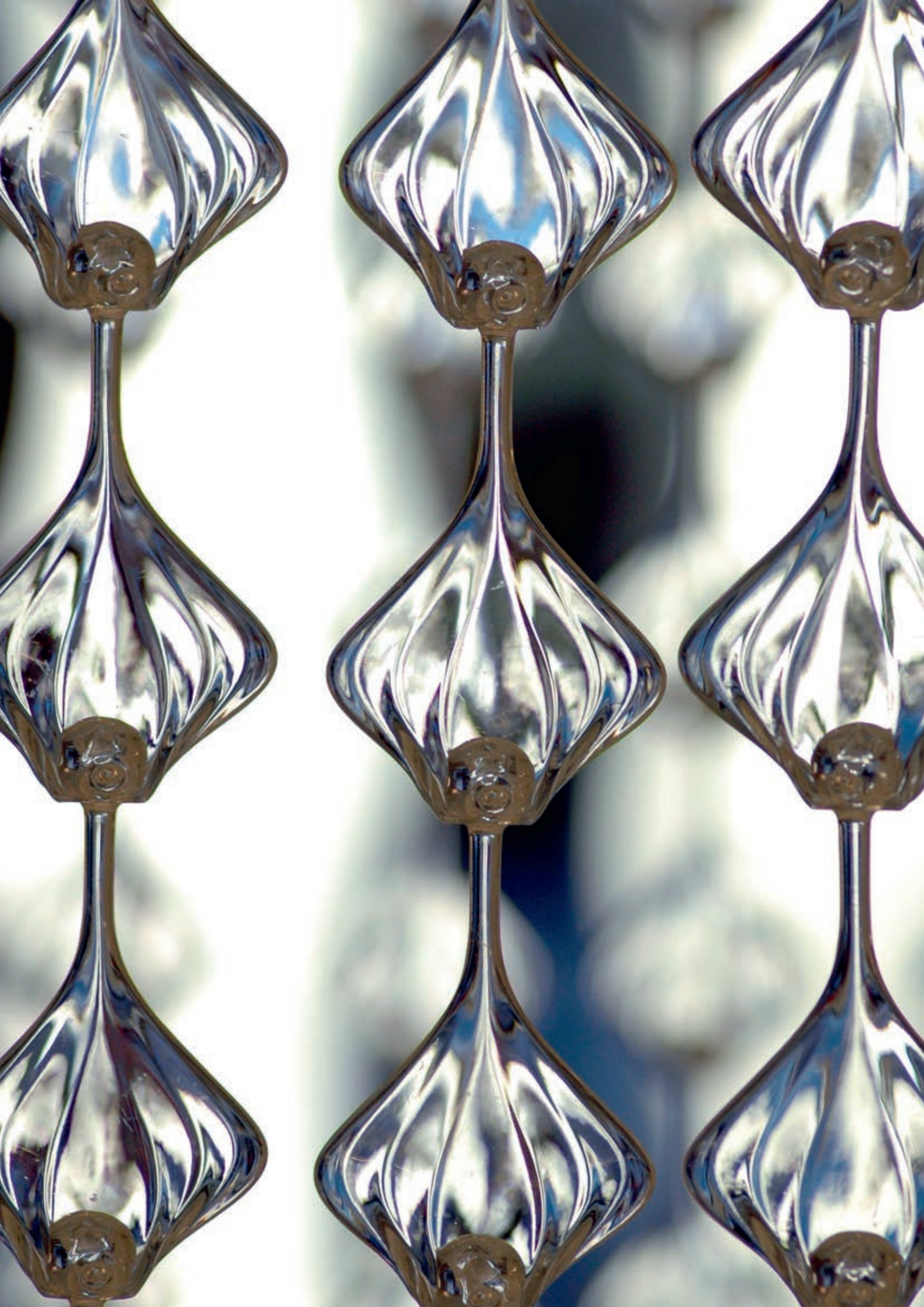

Logico soffitto
 Logico mini soffitto
 Logico micro soffitto
 Logico nano soffitto

design
 Michele De Lucchi
 Gerhard Reichert
 2001, 2002, 2003, 2006

Light emission



Colours



Materiali: struttura in metallo verniciato; diffusore in vetro soffiato con finitura seta lucida. Soffiatura a tre strati (cristallo + effetto seta + cristallo) in stampo a fermo con forma capovolta per garantire solidità strutturale del vetro.

Specificità: la forma modulare si presta alla componibilità e alla realizzazione di combinazioni personalizzate, fornite come progetto speciale.

Awards

2002 – Design Innovationen
 Design Zentrum Nordrhein Westfalen
 Reddot Design Award
 Essen (Deutschland)

Materials: painted metal structure, blown glass diffuser with a polished-silk finish. Three layers of glass (crystal + silk + crystal) are blown in an upside down mould to ensure structural consistence to glass.

Matériaux : structure en métal verni ; diffuseur en verre soufflé, finition soie brillante. Verre soufflé en trois couches (cristal + effet soyeux + cristal) dans un moule qui a une forme inversée pour garantir la solidité structurale du verre.

Materialien: Rahmen aus lackiertem Metall; Schirm aus geblasenem Glas in seidig glänzendem Finish. Drei Glasschichten (Kristall + Seide + Kristall) die umgekehrt positioniert sind um die Stabilität des Glases zu gewährleisten.

Materiales: estructura de metal pintado; difusor de cristal soplado con acabado de seda brillante. Soplado a tres capas (cristal + efecto seda + cristal) en un molde con forma invertida para asegurar la resistencia estructural del cristal.

Specification: its modular shape lends itself to the creation and realisation of customized compositions, supplied as custom project.

Spécificité : sa forme modulaire permet de personnaliser les compositions; produit spécial à définir pour tout projet.

Spezifikation: Die Leuchtenmodule erlauben eine individuell gestaltete Anordnung, die als kundenspezifische Lichtlösung erhältlich sind.

Especificaciones: su forma modular, se presta para realizar combinaciones personalizadas, suministrado como proyecto especial.



Logico soffitto



Logico soffitto 3 in linea



Logico soffitto mini 4x90°



Logico soffitto 3x120°

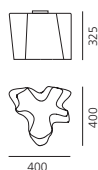

Logico soffitto

HALO max 1x105W (E27)
Dimmable
or FLUO 1x23W (E27) – TC-TSE
or **LED** max 1x17W (E27)



Energy Label n°6

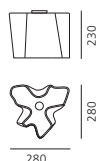

Logico mini soffitto

HALO max 1x77W (E27)
Dimmable



Energy Label n°6

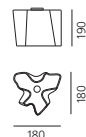

Logico micro soffitto

HALO max 1x46W (E14)
Dimmable
or FLUO 1x8W (E14)
or **LED** max 1x4,5W (E14)



Energy Label n°30



Logico nano soffitto

HALO max 1x46W (E14)
Dimmable



Energy Label n°30

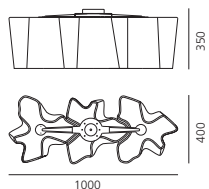

Logico soffitto 3 in linea

HALO max 3x105W (E27)
Dimmable
or FLUO 3x23W (E27) – TC-TSE
or **LED** max 3x17W (E27)



Energy Label n°6

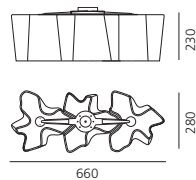

Logico mini soffitto 3 in linea

HALO max 3x77W (E27)
Dimmable



Energy Label n°6

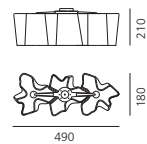

Logico micro soffitto 3 in linea

HALO max 3x46W (E14)
Dimmable
or FLUO 3x8W (E14)
or **LED** max 3x4,5W (E14)



Energy Label n°30

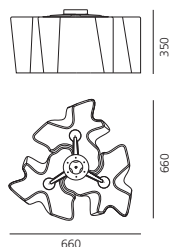

Logico soffitto 3x120°

HALO max 3x105W (E27)
Dimmable
or FLUO 3x23W (E27) – TC-TSE
or **LED** max 3x17W (E27)



Energy Label n°6

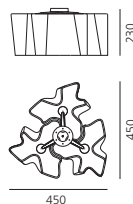

Logico mini soffitto 3x120°

HALO max 3x77W (E27)
Dimmable



Energy Label n°6

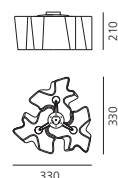

Logico micro soffitto 3x120°

HALO max 3x46W (E14)
Dimmable
or FLUO 3x8W (E14)
or **LED** max 3x4,5W (E14)



Energy Label n°30

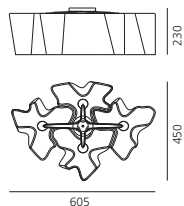

Logico mini soffitto 4x90°

HALO max 4x77W (E27)
Dimmable



Energy Label n°6

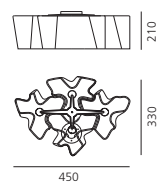

Logico micro soffitto 4x90°

HALO max 4x46W (E14)
Dimmable
or FLUO 4x8W (E14)
or **LED** max 4x4,5W (E14)



Energy Label n°30



Only for custom projects –
which feasibility must be approved by Artemide
technical design department – it's possible
to create different combinations by joining
the elements Logico soffitto.



Lampade a sospensione

Suspension lamps

Suspensions

Pendelleuchten

Suspensiones



326
Unterlinden



330
Pirce sospensione,
mini sospensione



330
Pirce micro
sospensione



350
Null Vector



354
Altrove
sospensione



356
Altrove TW
sospensione



372
Empatia sospensione



374
Meteorite
sospensione



376
Laguna sospensione



388
Droplet
sospensione



390
Mercury sospensione,
mini sospensione



394
Cosmic Angel
sospensione



406
Cosmic Rotation
sospensione



407
Cosmic Landscape
sospensione



408
Empirico sospensione,
Empirico System



334
Space Cloud
sospensione



336
Scopas
sospensione

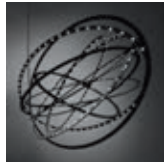

338
Copernico
sospensione



340
Copernico 500
sospensione



342
Led Net line
sospensione



344
Led Net circle
sospensione



346
Aggregato sosp.
sosp. saliscendi



348
Fiamma
sospensione



357
Altrove 600
sospensione



358
Tian Xia
Metamorfofi
sospensione



360
Tian Xia 500 Led
sospensione



362
Nur, Nur1618,
Nur mini
sospensione



366
Nur gloss,
Nur gloss mini
sospensione



368
Talo
sospensione



370
Float sospensione
circolare



370
Float sospensione
lineare



378
Castore
sospensione



380
Castore calice
sospensione



381
Edge
sospensione



382
Miconos
sospensione



384
Logico sospensione
mini, micro, nano



384
Logico sospensione
3 in linea



384
Logico sospensione
3x120°



384
Logico sospensione
4x90°



396
Aqua Cil
sospensione



397
Cabildo
sospensione



398
Tolomeo sospensione
due bracci alluminio



399
Tolomeo sospensione
due bracci pergamena



400
Tolomeo sospensione
decentrata



402
Tolomeo mega
sospensione



404
Choose sospensione,
mega sospensione



410
Calenda
sospensione



411
Nuboli
sospensione



412
Mouette simmetrica
Mouette asimmetrica



412
Mouette mini
sospensione

Unterlinden

design

Herzog & de Meuron
2014

Light emission



Colours



Bronze



Aluminium

Lampada a sospensione concepita per installazioni museali, che coniuga il fascino estetico di un oggetto di altri tempi ad un alto valore tecnologico ed illuminotecnico.

Materiali: corpo lampada realizzato con una pressofusione di alluminio o bronzo; rosone a soffitto in polimero tecnico; piastra di fissaggio a soffitto in acciaio.

Specificità: la sorgente luminosa è un LED COB; Il flusso luminoso è controllato anche da una lente in polimero ad alta efficienza ottica studiata appositamente per concentrare il fascio luminoso. Il corpo lampada ha una duplice funzione: dissipare il calore prodotto dalla sorgente ed indirizzare il flusso luminoso verso il basso.

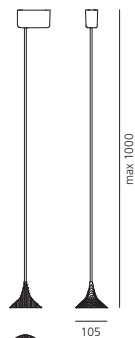

LED Total power 7W
Color temperature 3000K
Lighting output 615lm
Dimmable

IP20 +  - Dimmer

Energy Label n°1

A suspension lamp designed for museum lighting, combining the aesthetic charm of an old-time object with high technology and engineering.

Materials: lamp body in die-cast aluminium or bronze; ceiling rose in technopolymer; ceiling fixing plate in steel.

Specification: the light source is a COB LED to ensure a maximum luminous efficiency. The light beam is also controlled by a high-efficiency optic polymeric lens especially designed to collimate light. The lamp body has a dual function: dissipate the heat produced by the LED source and direct the luminous flow downwards.

Suspension conçue pour des installations muséales qui conjugue le charme esthétique d'un objet d'autrefois à une haute valeur technologique et technique.

Matériaux : corps réalisé en aluminium ou bronze ; rosace en techno-polymère ; plaque de fixation en acier.

Spécificités : la source lumineuse est une LED COB ; le flux lumineux est aussi contrôlé par une lentille en polymère à haute efficacité optique étudiée pour concentrer le faisceau lumineux. Le corps de la lampe a une double fonction : dissiper la chaleur produite par la source et maîtriser le flux lumineux.

Pendelleuchte, die für Museen konzipiert wurde und die Nostalgie eines antiken Objektes und höchsten technologischen Anspruch vereint.

Materialien: Leuchtenkörper hergestellt aus Aluminium- oder Bronze; Deckenbalдахin aus Technopolymer; Deckenbefestigungsplatte aus Stahl.

Spezifikation: Eine COB-LED fungiert als Lichtquelle, um maximalen Wirkungsgrad und niedrige Energiekosten zu gewährleisten. Die speziell entwickelte Linse aus Polymer ermöglicht optische Effizienz und einen konzentrierten Lichtstrahl. Der Leuchtenkörper lenkt das Licht nach unten und dient gleichzeitig der Wärmeableitung.

Lámpara de suspensión concebida para instalaciones en museos, que conjuga la fascinación estética de un objeto de otros tiempos con un alto valor tecnológico y luminotécnico.

Materiales: cuerpo lámpara realizado con una fundición de aluminio y bronce; rosetón a techo en polímero; plancha de fijación a techo en acero.

Especificaciones: la fuente de luz es un LED COB; el flujo luminoso está controlado por una lente en polímero de alta eficiencia óptica estudiada a propósito para concentrar el haz luminoso. El cuerpo de la lámpara tiene una doble función: disipar el calor producido por la fuente de luz y direccionar el flujo luminoso hacia abajo.







Pirce sospensione
Pirce mini sospensione
Pirce micro sospensione

design

Giuseppe Maurizio Scutellà
2008, 2012, 2013



Light emission



Colour



White



Black
(only LED)



Gold
(only LED)

Awards

2010 – iF Produkt Design Award
Hannover (Deutschland)
2008 – Good Design Award
The Chicago Atheneum
Chicago (US)

Materiali: alluminio verniciato.

Specificità: da un disco sottile si aprono volute fluttuanti, che ricadono morbidamente verso il basso, creando magici effetti di forma e luce.

Materials: painted aluminium.

Matériaux : aluminium verni.

Materialien: Lackiertes Aluminium.

Materiales: aluminio pintado.

Specification: from a thin ceiling plate, gently descending waving spirals create enchanting effects of form and light.

Spécificité : un disque mince donne naissance à des volutes flottantes qui retombent doucement vers le bas en créant des effets magiques de formes et de lumière.

Spezifikation: Eine feine Scheibe geht in sanft geschwungene Spiralen über, die sich spiralförmig nach unten neigen und magische Lichteffekte erzeugen.

Especificaciones: de un disco fino parten volvas fluctuantes que caen suavemente hacia abajo, creando mágicos efectos de forma y luz.

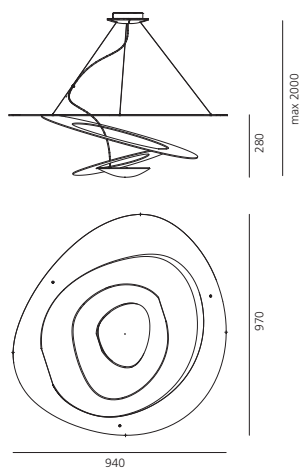

Pirce sospensione LED

LED Total power 44W
Color temperature 3000K
Lighting output 3344lm
Dimmable



Energy Label n°1

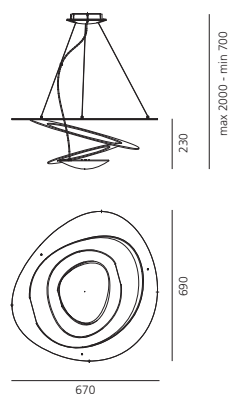

Pirce mini sospensione LED

LED Total power 44W
Color temperature 3000K
Lighting output 3344lm
Dimmable



Energy Label n°1

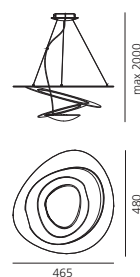

Pirce micro sospensione LED

LED Total power 29W
Color temperature 3000K
Lighting output 2237lm
Dimmable 1-10V



Energy Label n°1

Pirce sospensione Halo

HALO max 1x330W (R7s)
Lamp included
Dimmable



Energy Label n°5

Pirce mini sospensione Halo

HALO 1x330W (R7s)
Lamp included
Dimmable



Energy Label n°5





Pirce mini black

Pirce micro white



Space Cloud

design

Ross Lovegrove
2014

Light emission



Colours



White

Materiali: layers microforati in alluminio anodizzato; corpo illuminante in pressofusione di alluminio lucidato; rosone in tecnopolimero plastico con rivestimento in alluminio lucido; cavi di sospensione in acciaio.
Specificità: lampada a sospensione a LED caratterizzata da quattro layers che riflettono la luce emessa dalla sorgente posta nella parte inferiore, creando un piacevole effetto di luci ed ombre sul soffitto.

Materials: layers in anodized aluminium; painted die-cast aluminium body lamp; ceiling rose in steel sheet; cover in technopolymer and aluminium; steel suspension cables.

Matériaux : couches en aluminium anodisé, corps en aluminium moulé sous pression peint ; rosace en lamelle d'aluminium et couverture en polymère, câbles de suspension en acier.

Materialien: Schichten aus gelochtem, eloxiertem Aluminium; Leuchtenkörper aus druckgegossenem, poliertem Aluminium; Baldachin aus Technopolymer mit Aluminiumbeschichtung; Stahlseilabhängung.

Materiales: capas de aluminio anodizado; cuerpo lámpara de aluminio fundido a presión; rosetón en polímero y cubierto de aluminio; cables de suspensión en acero.

Specificità: LED suspension lamp made of four layers in anodized aluminium reflecting the light emitted by the LED source at the bottom of the fitting, while producing a pleasant light and shading effects on the ceiling.

Spécificités : suspension LED caractérisée par 4 superpositions du disque qui réfléchissent la lumière émise par la source positionnée dans la partie inférieure produisant ainsi un agréable effet de lumières et d'ombres au plafond.

Spezifikation: Das Licht, das die im unteren Bereich sitzende LED Lichtquelle abgibt, wird durch die vier Ebenen reflektiert, wodurch ein bezaubernder Licht- und Schatteneffekt an der Decke entsteht.

Especificaciones: lámpara de suspensión a LED caracterizada por cuatro capas que reflejan la luz emitida por la fuente de luz situada en la parte inferior creando un efecto placentero de luces y sombras en el techo.

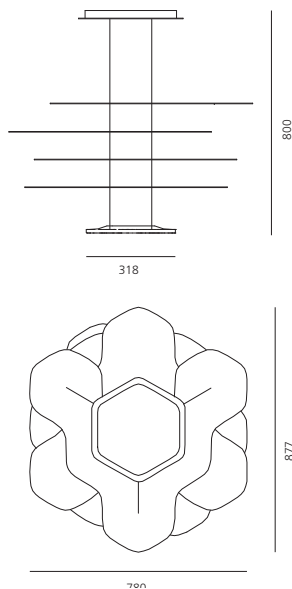

LED Total power 43W
Color temperature 3000K
Lighting output 3158lm

Dimmable

IP20  EAC

Energy Label n°1

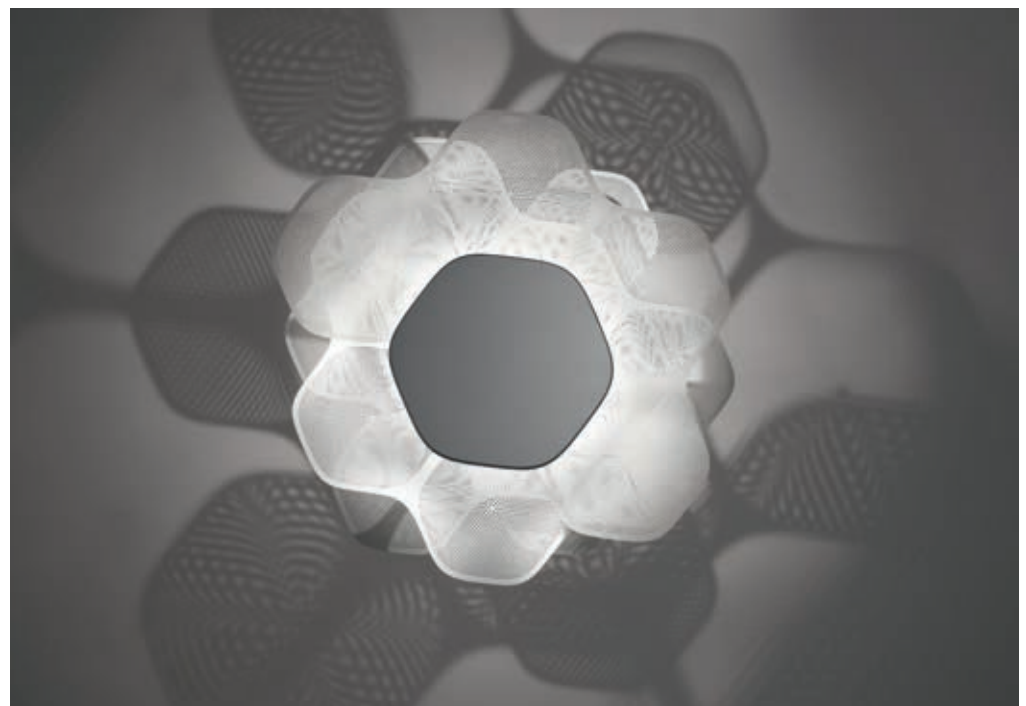



Scopas

design

Neil Poulton
2013

Light emission



Colours



White/Black

La ripetizione di un modulo elementare materializza una sfera incompleta, in sospeso.

Materiali: struttura in alluminio pressofuso verniciato; lenti in metacrilato diffondente; rosone in tecnopolimero con finitura verniciata.

The repetition of a simple module creates an incomplete suspended structure.

C'est une répétition d'un module élémentaire qui forme une sphère incomplète en suspension.

Durch Wiederholung eines elementaren Moduls wirkt diese Pendelleuchte wie eine Kugel mit unvollständiger Struktur.

La repetición de un módulo elemental se materializa en una esfera incompleta; en suspensión.

Materials: lamp body in die-cast aluminium; methacrylate lens; ceiling rose in technopolymer.

Matériaux : corps réalisé en aluminium ; lentille en méthacrylate ; rosace en techno-polymère.

Materialien: Leuchtenkörper aus lackiertem Aluminiumdruckguss; Linse aus Methacrylat; Deckenbaldachin aus lackiertem Technopolymer.

Materiales: cuerpo lámpara realizado con una fundición de aluminio; lentes de metacrilato; rosetón a techo en polímero; plancha de fijación a techo en plancha de fijación a techo en polímero.

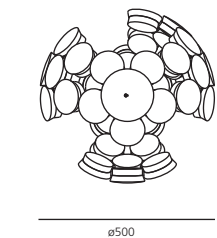
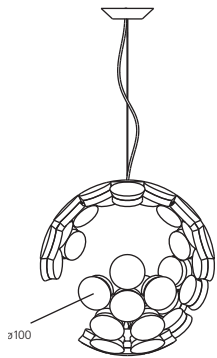

LED Total power 80W
Color temperature 3000K
Lighting output 2912lm
Dimmable

IP20  EAC

+  - Dimmer

Energy Label n°1

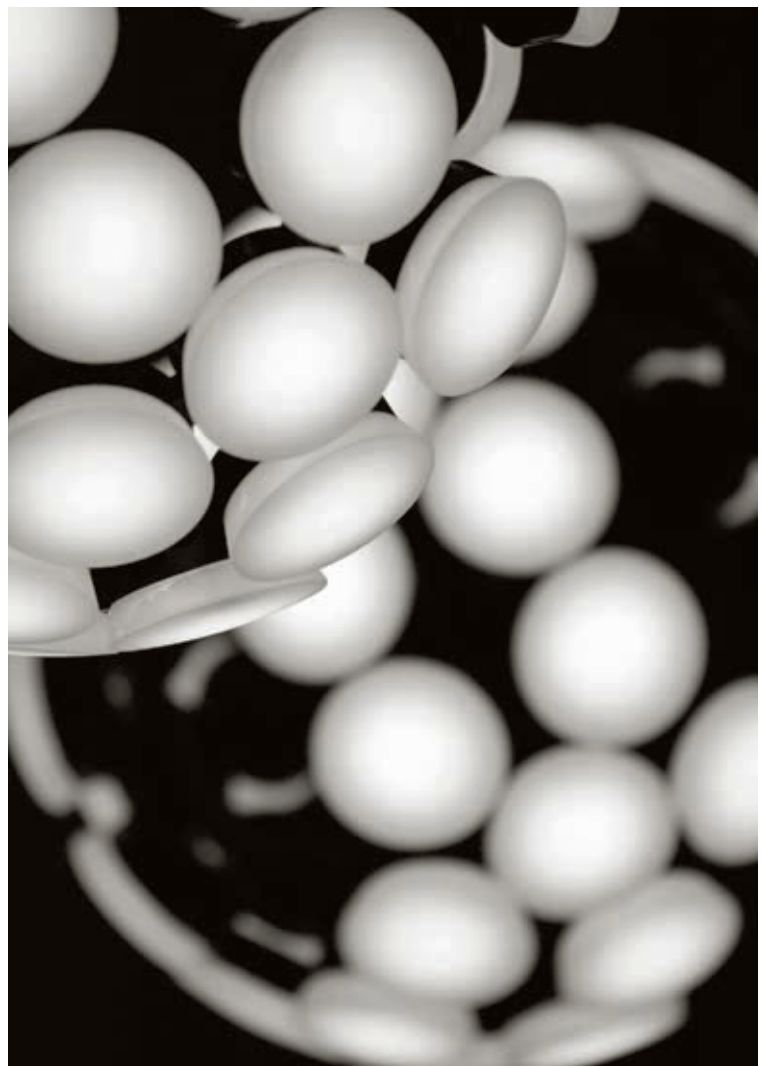



Copernico sospensione

Design

Carlotta de Bevilacqua
Paolo Dell'Elce
2010

Patent Pending
n. MI20104000610



Light emission



Colours

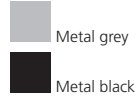

Materiali: alluminio anodizzato.

Specificità: nove ellissi concentriche e mobili ricavate da un'unica lastra di alluminio supportano un circuito di 384 LED bianchi; le ellissi ruotano indipendentemente su due diversi assi, permettendo di orientare l'emissione luminosa e contemporaneamente di ottenere numerose configurazioni spaziali. Quando è chiuso l'apparecchio si presenta completamente piatto.

Awards

2011– Design Innovationen
Design Zentrum Nordrhein Westfalen
Reddot Design Award
Essen (Deutschland)

2014 – Compasso d'Oro / A.D.I.
Milano (Italia); Honorable Mention

Materials: anodised aluminium.

Specification: a circuit of 384 white LEDs is installed into nine concentric elements created from a single aluminium plate. The ellipses rotate independently on the two different axes, enabling the adjustment of the light emission and the creation of multiple configuration. When off the device is completely flat.

Matériaux : aluminium anodisé.

Spécificité : neuf ellipses concentriques et mobiles, obtenues à partir d'une seule plaque d'aluminium, soutiennent un circuit de 384 LEDs blanches. Ces ellipses tournent indépendamment sur deux axes différents, ce qui permet à la fois d'orienter l'émission de lumière et d'obtenir de nombreuses configurations spatiales.

Materialien: eloxiertes Aluminium.

Spezifikation: Neun konzentrische, aus einer einzigen Aluplatte gefertigte Ellipsen, auf denen eine Leiterplatte mit 384 weißen LED angebracht ist. Die Ellipsen lassen sich unabhängig voneinander um zwei Achsen drehen, so dass eine individuelle Ausrichtung des Lichtstrahls erzielt wird und immer wieder neue Konfigurationen im Raum entstehen. In geschlossenem Zustand hat die Leuchte eine vollständig flache Form.

Materiales: aluminio anodizado.

Especificaciones: nueve elipses concéntricas y móviles, realizadas a partir de una única placa de aluminio, hacen de base a un circuito de 384 LEDs blancos. Las elipses giran independientemente a lo largo de dos ejes diferentes, detalle que permite orientar el haz luminoso y obtener paralelamente numerosas configuraciones espaciales. Cuando el artefacto está cerrado es completamente plano.

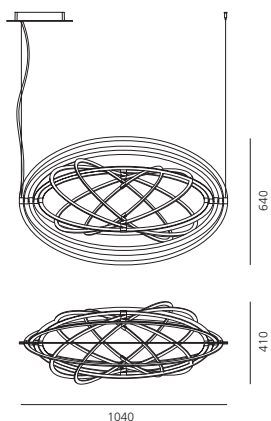
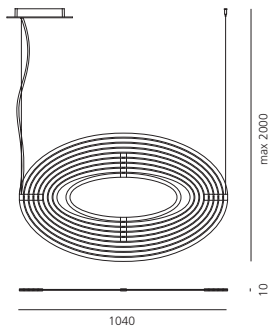

LED Total power 38W
Color temperature 3000K
Lighting output 2565lm
Dimmable



Energy Label n°1



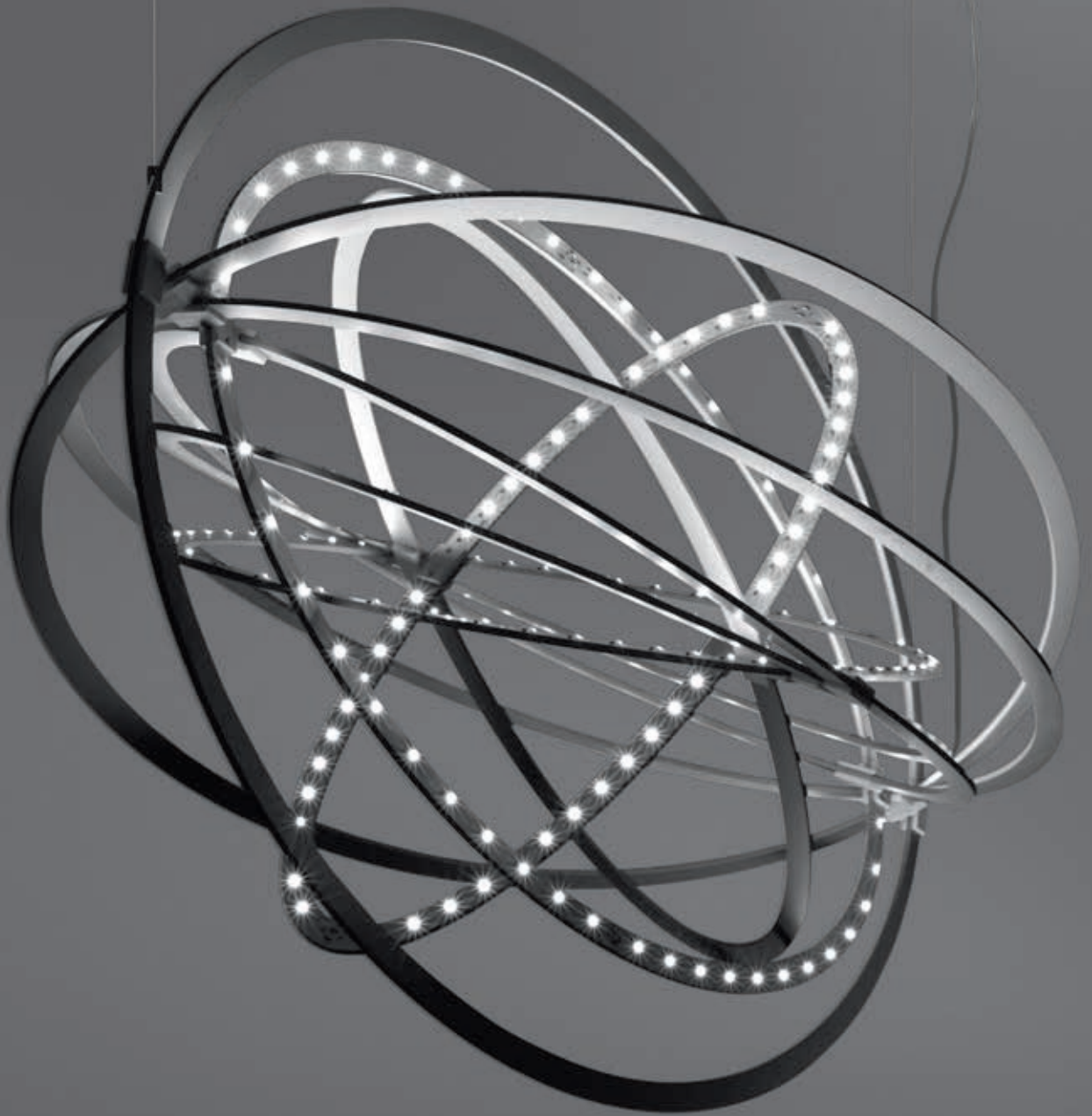

Copernico 500 sospensione

design

Carlotta de Bevilacqua
Paolo Dell'Elce
2012

Patent Pending
n. MI20104000610



Light emission



Colours



Polished white



Polished red

Copernico è ricavato da un unico foglio di alluminio anodizzato tagliato al Laser; quando chiuso l'apparecchio si presenta completamente piatto. Lo snodo con contatti in rame (patent pending) permette il passaggio dell'alimentazione tra le ellissi concentriche che compongono la struttura, e abilita la rotazione indipendente di 360° di queste. La mobilità degli elementi e le sorgenti LED in bassissima tensione permettono all'utente di configurare la luce nello spazio impugnando e muovendo fisicamente l'oggetto, modulando l'emissione a seconda delle esigenze. **Materiali:** alluminio verniciato; PCB.

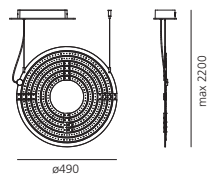

LED total power 27W
Color temperature 3000K
Lighting output 2375lm
Dimmable



Energy Label n°1

Copernico is obtained from a single laser-cut sheet of anodised aluminium; when off the device appears completely flat. The articulation with copper contacts (patent pending) allows the power supply to pass between the concentric ellipses that make up the structure, and enables these to be rotated independently over 360°. The mobility of the elements and the low voltage LED light sources allow users to configure the light in space by clasping and physically moving the object, modulating emission according to need.

Materials: painted aluminium; PCB.

Copernico est réalisée avec une seule feuille en aluminium anodisé découpée au laser. Quand il est fermé, l'appareil se présente sous une forme complètement plate. L'articulation à contacts en cuivre (patent pending) assure le passage de l'alimentation entre les ellipses concentriques qui composent la structure et permet à chacune de ces dernières de tourner sur 360°. La mobilité des éléments et les sources LED à très basse tension permettent à l'utilisateur de configurer la lumière dans l'espace, en saisissant et en déplaçant matériellement l'objet, en modulant l'émission en fonction des exigences.

Matériaux : aluminium peint; PCB.

Copernico wird mit Lasertechnik aus einer eloxierten Aluminiumplatte ausgeschnitten; die geschlossene Leuchte ist ganz flach. Das Gelenk mit den Kupferkontakten (zum Patent angemeldet) ermöglicht den Übergang der Stromversorgung zwischen den konzentrischen Ellipsen der Struktur und die voneinander unabhängige 360°-Drehung derselben. Die Mobilität der Elemente und der mit Kleinspannung funktionierenden LED-Lichtquellen ermöglicht es dem Benutzer, das Licht im Raum einfach durch Anfassen und Bewegen der Leuchte zu konfigurieren und den Lichtaustritt nach individuellem Bedarf zu steuern.

Materialien: Lackiertes Aluminium; PCB.

Copernico se construye a partir de una sola hoja de aluminio anodizado, que se corta con láser. Cuando está cerrada, queda completamente plana. La articulación con contactos de cobre (cuya patente se está tramitando) permite modificar la alimentación, pasando a través de las elipses concéntricas que forman la estructura. Y acciona la rotación independiente de las mismas a 360°. La capacidad de movimiento de los elementos y las fuentes luminosas de LED de muy baja tensión hacen que el usuario logre configurar la luz en el espacio. Para modular la emisión a voluntad, basta empuñar y desplazar el objeto.

Materiales: aluminio pintado; PCB.





Led Net line 66 sospensione
Led Net line 125 sospensione

design

Michele De Lucchi
Alberto Nason
2010, 2011



Light emission



Colour



Polished White

Awards

Led Net line 125 sospensione

2010 – IF Produkt Design Award
Design Quality
Hannover (Deutschland)
2012 – Design Plus Light+Building award
Frankfurt (Deutschland)

Materiali: struttura in alluminio verniciato. Ogni LED è dotato di lente in metacrilato trasparente e di porta-lente in metacrilato satinato.
Specificità: modulo componibile che permette numerose aggregazioni (fornito come progetto custom). Grazie al ridotto cono di emissione (70°), Led Net line è anche adatto per uffici, dove è richiesto il controllo dell'abbagliamento.

Materials: painted aluminium structure. Each LED is fitted with a transparent methacrylate lens and a satin finish methacrylate lens-holder.

Specification: modular unit allowing the addition of multiple elements (supplied as custom products). Thanks to its reduced angular emission cone (70°), Led Net line is also suitable for offices, where glare control is needed.

Matériaux : structure en aluminium peint. Chaque LED est munie d'une lentille en méthacrylate transparent et d'un porte-lentille en méthacrylate satiné.

Spécificité: module unitaire permettant de nombreuses compositions (produit spécial à définir pour tout projet). Grâce au réduit cône d'émission (70°), Led Net line est également adapté pour les bureaux, où le contrôle d'éblouissement est nécessaire.

Materialien: Struktur aus lackiertem Aluminium. Alle LED mit Linse aus transparentem Methacrylat und Linsenträger aus mattem Methacrylat.

Spezifikation: Die Einzelelemente können als kundenspezifische Lichtlösung zu einer großen Konfiguration zusammen gefügt werden. Dank des kleinen Abstrahlwinkels (70°), ist Led Net line auch für Büros geeignet, in denen ein Blendschutz erforderlich ist.

Materiales: estructura de aluminio pintado. Cada LED consta de lente de metacrilato transparente y de porta-lente de metacrilato satinado.

Especificaciones: módulos componibles que permiten numerosas composiciones (suministro como proyecto especial). Gracias al cono de emisión reducida (70°), Led Net line es también apto para oficinas, donde se requiere el control del deslumbramiento.

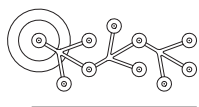
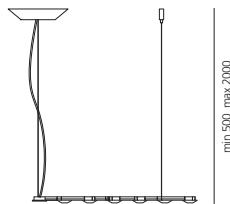

660

Led Net line 66 sospensione

9 LED Total power 23W
Color temperature 3000K
Lighting output 1313lm
Not dimmable

IP20

Energy Label n°1

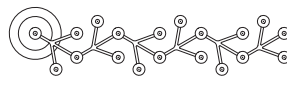
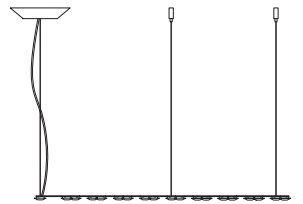

1250

Led Net line 125 sospensione

18 LED Total power 45W
Color temperature 3000K
Lighting output 2530lm
Dimmable

IP20

Energy Label n°1

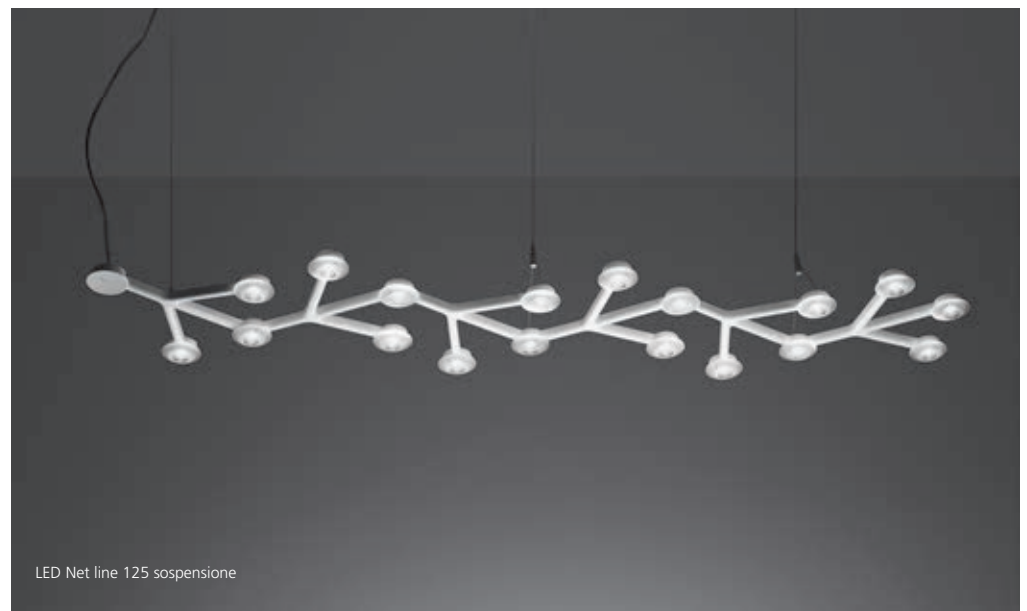

LED Net line 125 sospensione



Led Net circle sospensione

design

Michele De Lucchi
Alberto Nason
2010, 2011



Light emission



Colours



Polished White

Materiali: struttura in alluminio verniciato. Ogni LED è dotato di lente in metacrilato trasparente e di porta-lente in metacrilato satinato.
Specificità: grazie al ridotto cono di emissione (70°), Led Net circle è anche adatto per uffici, dove è richiesto il controllo dell'abbagliamento.

Materials: painted aluminium structure. Each LED is fitted with a transparent methacrylate lens and a satin finish methacrylate lens-holder.

Matériaux: structure en aluminium peint. Chaque LED est munie d'une lentille en méthacrylate transparent et d'un porte-lentille en méthacrylate satiné.

Materialien: Struktur aus lackiertem Aluminium. Alle LED mit Linse aus transparentem Methacrylat und Linsenträger aus mattem Methacrylat.

Materiales: estructura de aluminio pintado. Cada LED consta de lente de metacrilato transparente y de porta-lente de metacrilato satinado.

Specification: thanks to its reduced angular emission cone (70°), Led Net circle is also suitable for offices, where glare control is needed.

Spécificité: grâce au réduit cône d'émission (70°), Led Net circle est également adapté pour les bureaux, où le contrôle d'éblouissement est nécessaire.

Spezifikation: Dank des kleinen Abstrahlwinkels (70°), ist Led Net circle auch für Büros geeignet, in denen ein Blendschutz erforderlich ist.

Especificaciones: gracias al cono de emisión reducida (70°), Led Net circle es también apto para oficinas, donde se requiere el control del deslumbramiento.

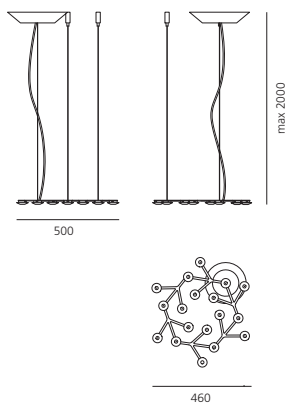

18 LED Total power 43W
Color temperature 3000K
Lighting output 2502lm
Dimmable



Energy Label n°1





Aggregato sospensione
 Aggregato sosp. decentrata
 Aggregato sosp. saliscendi

design

Enzo Mari
 Giancarlo Fassina
 1976, 1995



Light emission



Colours

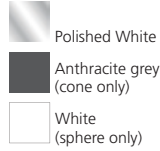

Awards

BIO 7 – Honourable Mention
 1977 – Ljubljana (Slovenia)

Museums

Museo Permanente del Design Italiano
 1945/1990 – Triennale di Milano
 Milano (Italia)

Materiali: rosone in resina termoplastica e metallo verniciati; contrappeso in resina termoplastica trasparente; diffusori conici in metacrilato o metallo; diffusori sferici in metacrilato.

Specificità: lampada con diffusori intercambiabili. Disponibile con cavo fisso o saliscendi con contrappeso.

Materials: ceiling rose in thermoplastic resin and metal, painted; counterweight in thermoplastic transparent resin; cone-shaped diffuser in methacrylate or in metal; sphere-shaped diffuser in methacrylate.

Matériaux : rosace en résine thermoplastique et métal verni ; contrepoids en résine thermoplastique transparente; diffuseurs coniques en méthacrylate ou en métal ; diffuseurs sphériques en méthacrylate.

Materialien: Baldachin aus Kunstharz und Metall, lackiert; Gegengewicht aus transparentem Kunstharz; kegelförmiger Schirm aus Methacrylat oder aus Metall; kugelförmiger Schirm aus Methacrylat.

Materiales: rosetón, de resina termoplástica y metal pintados; contrapeso de resina termoplástica transparente; difusores cónicos de metacrilato o metal; difusores esféricos de metacrilato.

Specification: lamp with interchangeable diffusers. Available with fixed cable or rise and fall counterweight.

Spécificité : suspension avec diffuseurs interchangeables. Disponible avec câble fixe ou monte et baisse avec contrepoids.

Spezifikation: Die Schirme der Pendelleuchte sind austauschbar. Auf Wunsch mit höhenverstellbarem Kabel erhältlich.

Especificaciones: lámpara con difusores intercambiables. Está disponible con cable fijo o de sube y baja, con contrapeso.

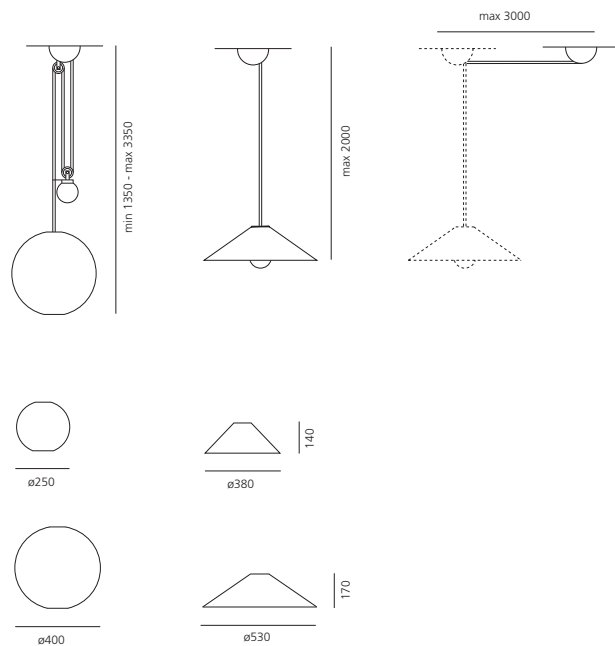

HALO max 1x77W (E27)
 Dimmable
 or FLUO max 1x20W (E27)
 or LED max 1x14,5W (E27)



Energy Label n°6

Aggregato sospensione only



Energy Label n°6



Aggregato sospensione

Aggregato sospensione saliscendi



Fiamma sospensione

design

Jean-Michel Wilmotte
2014

Light emission



Colour

Anodized
blackAnodized
grey

Materiali: corpo della lampada in alluminio estruso modellato meccanicamente; rosone a soffitto in tecnopolimero verniciato.

Materials: lamp body in extruded aluminum mechanically moulded; ceiling rose in painted technopolymer.

Matériaux : corps en aluminium extrudé usiné ; rosace en techno-polymère verni.

Materialien: leuchtenkörper aus fließgepresstem Aluminium; Deckenbaldachin aus lackiertem Technopolymer.

Materiales: cuerpo de la lámpara en aluminio extruido moldeado mecánicamente; rosetón a techo en polímero.

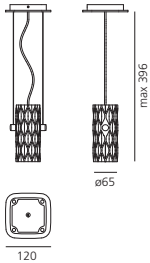

LED max 8W (GU10)

Not dimmable

IP20  EAC

Energy Label n°9





Light emission



Colours



Materiali: corpo in alluminio forato e tranciato; diffusore in policarbonato satinato texturizzato; rosone in tecnopolimero.

Specificità: l'intera struttura, caratterizzata da un pattern di fori, si genera da una crescita scalare di un singolo stampo di foratura e tranciatura che si declina nelle due versioni Alfa e Beta. Lo studio calcolato dell'emissione luminosa nello spazio si traduce in elemento grafico a supporto dell'esperienza percettiva, grazie al superamento dei limiti dettati dalla tecnologia di lavorazione del materiale stesso.

Materials: body in punctured and sheared aluminum; diffuser in textured satin polycarbonate, ceiling rose in technopolymer.

Matériaux : corps en aluminium percé ; diffuseur en polycarbonate satiné texturé; rosace en technopolymère.

Materialien: Körper aus gelochtem und gestanztem Aluminium; Schirm aus satiniertem, strukturiertem Polycarbonat; Deckenbaldachin aus Technopolymer.

Materiales: cuerpo en aluminio perforado y cortado; difusor en policarbonato satinado; rosón a techo en polímero.

Specification: the whole structure features an escalating growth of a single puncture and shear mould designed in two versions, Alfa and Beta. Extensive research of light emission in space is translated into a graphic element supporting perceptual experience while exceeding the limits of the materials' manufacturing properties.

Spécificités : la structure, caractérisée par un ensemble de trous, se développe à partir d'une croissance progressive de perçage. Elle se décline en version Alfa et Beta. L'étude calculée de l'émission lumineuse dans l'espace se traduit en élément graphique qui est support de l'expérience perceptive grâce au dépassement des limites dictées par la technologie de production.

Spezifikation: Das Muster wurde aus einer stetig wachsenden Form aus Lochungen und Stanzungen generiert und auf die zwei Versionen Alfa und Beta zugeschnitten. Beleuchtung, Wahrnehmung und Mechanik bilden die Grundaspekte der Matrix, die zum einen aus einer Studie der Lichtemission innerhalb eines grafischen Raums übertragen wurde und andererseits das Ergebnis der Überwindung der Grenzen der Technologie und Materialverarbeitung darstellt.

Especificaciones: toda la estructura, caracterizada por un dibujo de agujeros, se forma por un aumento del estampado de agujeros y corte de molde, diseñado en las dos versiones Alfa y Beta. El estudio calculado de la emisión luminosa en el espacio se traduce en elemento gráfico de la experiencia perceptiva, gracias a la superación de los límites de la tecnología del proceso de elaboración del material mismo.

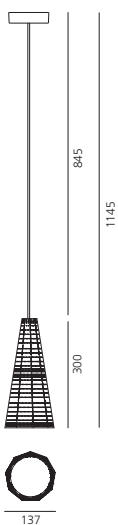
**Null vector α**

LED max 6W (E14)

Not dimmable

IP20  

Energy Label n°9

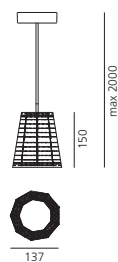
**Null vector β**

LED max 6W (E14)

Not dimmable

IP20  

Energy Label n°9









“Un m² di superficie dove la luce scorre fluida su fili trasparenti che attraverso un riflettore a specchio materializza un effetto luminoso volumetrico e controllato. È un m³ di luce nel quale ci si riflette all’infinito modulando liberamente più di un milione di effetti cromatici. Lo spazio non è più uno, ma diventa molti o semplicemente altro, percezione illusoria della realtà che porta verso un nuovo luogo, altrove.”

Materiali: struttura perimetrale in acciaio inox a specchio; diffusori laterali in Prismoptic satinato; diffusore frontale in metacrilato trasparente inciso; diffusore superiore in PETG trasparente.

Specificità: sono disponibili tre versioni che emettono luci differenti a seconda del riflettore. **Luce fluida:** con riflettore in alluminio lucido a specchio.

Luce volumetrica: con riflettore in alluminio lucido a specchio a segmenti ottici. **Doppia emissione:** con diffusore trasparente.

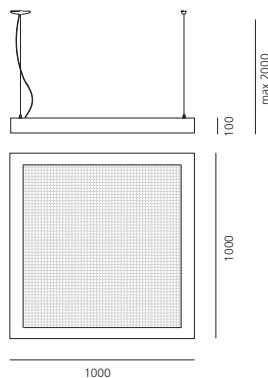

“In a m² of surface where the light flows in a fluid way on transparent wires and, through a mirrored reflector, materializes a lighting and volumetric effect which is controlled. It is a cubic metre of light where everything is endlessly reflected, freely modulating more than a million of chromatic effects. The space is no more just one, but several, or simply “else”, illusory perception of reality, which drivesto a new place, elsewhere.”

Un m² de surface où la lumière entre avec fluidité sur des fils transparents et au travers d’un réflecteur miroir. Altrove matérialise un éclairage à effet volumétrique commandé. C’est un mètre cube de lumière où celle-ci se réfléchit sans fin et qui module librement plus d’un million d’effets chromatiques. L’espace n’est plus un mais plusieurs ou simplement autre chose, perception illusoire de la réalité, qui mène à un nouvel endroit, ailleurs.

“Auf einer Fläche von einem Quadratmeter auf der das Licht in fließender Bewegung über transparente Nylonkabel geleitet und durch eine Spiegelfläche reflektiert wird, materialisiert sich das Licht und erzeugt einen einzigartigen, strukturierten Volumeneffekt. In einem Quadrat aus Licht“ das sich ins Endlose reflektiert, werden Millionen von farbigen Effekten erzeugt. Die Fläche hat damit nicht mehr nur eine, sondern viele oder einfach “weitere” scheinbare Realitäten, die zu einer neuen Dimension führen.“

Para materializar un efecto luminoso volumétrico y controlado, se ha creado un metro cuadrado de superficie donde la luz discurre con fluidez sobre hilos transparentes que cruzan un reflector en forma de espejo. Se trata de un metro cúbico de luz en el cual reflejarse hacia el infinito modulando libremente más de un millón de efectos cromáticos. El espacio ya no es único, sino que se convierte en una multitud de espacios o simplemente en uno distinto, en una percepción ilusoria de la realidad que nos conduce a un nuevo lugar, más allá.

FLUO 2x3 RGB groups (tot. 6) x 39W (G5) – T16
(234W total power)
Lamp included
With electronic ballast
Dimmable



Energy Label n°38

Materials: mirror stainless steel perimeter structure; side diffusers made of opaline Prismoptic; front diffuser in transparent engraved methacrylate; upper diffuser in transparent PETG.

Matériaux : structure périmétrale en acier inoxydable miroitant ; diffuseurs latéraux en Prismoptic opalin ; diffuseur frontal en méthacrylate transparent strié ; diffuseur supérieur en PETG transparent.

Materialien: Rahmen aus verspiegeltem Edelstahl; seitliche Reflektoren mit opaliner Prismoptic; Frontscheibe aus transparentem, graviertem Methacrylat; oberer Diffusor aus transparentem PETG.

Materiales: estructura perimetral de acero inoxidable con acabado espejo, difusores laterales de Prismoptic opalino, difusor frontal de metacrilato transparente; difusor superior en PETG transparente.

Specification: three versions are available, with two kind of reflector.

Fluid light: with mirror aluminium reflector.

Volumetric light: with segment reflector in mirror aluminium.

Direct/indirect emission: with transparent diffuser.

Spécificité: trois versions sont disponibles avec deux types de réflecteur.

Lumière fluide : avec réflecteur miroir.

Lumière volumétrique : avec lames de réflecteur miroir.

Double émission : avec diffuseur transparent.

Spezifikation: Erhältlich in drei Versionen:

Fließendes Licht: Reflektor aus verspiegeltem Aluminium.

Volumen erzeugendes Licht: Lamellenreflektor aus verspiegeltem Aluminium.

Direkter/indirekter Lichaustritt: mit transparentem Diffusor.

Especificaciones: están disponibles tres versiones que se caracterizan por dos tipos de reflector.

Luz fluida: con reflector en acabado espejo.

Luz volumétrica: con reflector de segmentos ópticos.

Doble emisión: con difusor transparente.



Infrared remote control (included)



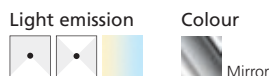

Versione della lampada Altrove a luce bianca, in cui è possibile combinare la temperatura di colore dimmerando le sorgenti calde e fredde attraverso due pulsanti a parete.

Materiali: struttura perimetrale in acciaio inox a specchio; diffusori laterali in Prismoptic satinato; diffusore frontale in metacrilato trasparente inciso; diffusore superiore in PETG trasparente.

Specificità: sono disponibili tre versioni che emettono luci differenti a seconda del riflettore.

Luce fluida: con riflettore in alluminio lucido a specchio.

Luce volumetrica: con riflettore in alluminio lucido a specchio a segmenti ottici.

Doppia emissione: con diffusore trasparente.

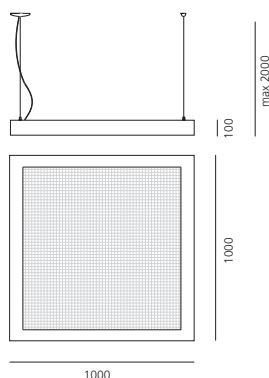

Altrove Tunable White allows the adjustment of colour temperature through two wall-mounted dimmable switches.

Version du modèle Altrove à lumière blanche avec lequel il est possible de gérer la température de couleur à l'aide de deux variateurs muraux déportés.

Weißlicht-Version der Altrove Pendelleuchte. Die Regelung der Farbtemperatur erfolgt über zwei Wandschalter mit Dimmung.

Altrove versión Tunable White, la cual es posible combinar la temperatura de color fría o cálida a través de dos interruptores de pared dimerables.

Materials: perimeter structure made of mirrored aluminium; side diffusers made of satin Prismoptic; front diffuser in engraved transparent methacrylate.

Matériaux : structure périmétrale en acier inoxydable miroitant ; diffuseurs latéraux en Prismoptic opalin ; diffuseur frontal en méthacrylate transparent strié ; diffuseur supérieur en PETG transparent.

Materialien: Rahmen aus verspiegeltem Edelstahl; seitliche Reflektoren mit opaliner Prismoptic; Frontscheibe aus transparentem, graviertem Methacrylat; oberer Diffusor aus transparentem PETG.

Materiales: estructura perimetral de acero inoxidable con acabado espejo, difusores laterales de Prismoptic opalino, difusor frontal de metacrilato transparente; difusor superior en PETG transparente.

FLUO 2x39W (G5) - T16
Color temperature 6500K (cold white)
Lamp included
+
FLUO 2x39W (G5) - T16
Color temperature 3000K (warm white)
Lamp included
With electronic ballast
Dimmable

Specification: available in three versions with different reflectors.

Fluid light: with mirrored aluminium reflector.

Volumetric light: with optical segment reflector in mirrored aluminium.

Direct/indirect emission: with transparent diffuser.

Spécificité : trois versions sont disponibles avec deux types de réflecteur:
Lumière fluide : avec réflecteur miroir.

Lumière volumétrique : avec lames de réflecteur miroir.

Double émission : avec diffuseur transparent.

Spezifikation: Erhältlich in drei Versionen:

Fließendes Licht: Reflektor aus verspiegeltem Aluminium.

Volumen erzeugendes Licht: Lamellenreflektor aus verspiegeltem Aluminium.

Direkt-indirekter Lichtaustritt: mit transparentem Diffusor.

Especificaciones: están disponibles tres versiones que se caracterizan por dos tipos de reflector.

Luz fluida: con reflector en acabado espejo.

Luz volumétrica: con reflector de segmentos ópticos.

Doble emisión: con difusor transparente.



Energy Label n°22

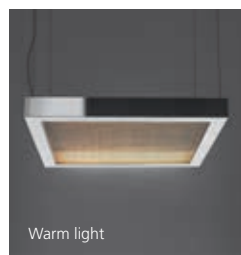

Light emission



Colour



Materiali: struttura perimetrale in acciaio inox a specchio; diffusori laterali in Prismoptic satinato; diffusore frontale in metacrilato trasparente inciso; diffusore superiore in PETG trasparente.

Specificità: sono disponibili le versioni a luce diretta e a doppia emissione.

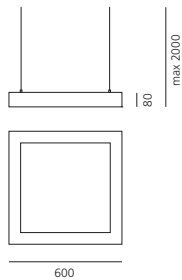

Materials: mirror stainless steel perimeter structure; matt finish Prismoptic lateral diffusers; engraved transparent methacrylate front diffuser; transparent PETG upper diffuser.

Matériaux : structure périmétrale en acier inoxydable miroitant ; diffuseurs latéraux Prismoptic satiné ; diffuseur frontal en méthacrylate transparent gravé ; diffuseur supérieur en PETG transparent.

Materialien: Rahmen aus verspiegeltem Edelstahl, seitliche Reflektoren mit opaliner Prismoptic; Frontscheibe aus transparentem, gravierten Methacrylat; oberer Diffusor aus transparentem PETG.

Materiales: estructura perimétrica de acero inoxidable con acabado espejo. Difusores laterales de Prismoptic satinado. Difusor frontal de metacrilato transparente grabado. Difusor superior de PETG transparente.

Specification: two versions are available: direct emission and direct/indirect emission.

Spécificité : deux versions sont disponibles: émission directe et double émission.

Spezifikation: Erhältlich mit direktem sowie direkt-indirektem Lichtaustritt.

Especificaciones: están disponibles dos versiones: emisión directa y doble emisión.

FLUO 2x55W (ZG11) – TC-LEL
Lamp included
With electronic ballast
Dimmable



Energy Label n°33

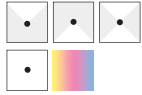

**Patent**n. 97100602.8
n. 03014108.9**Light emission****Colour**

Mirror

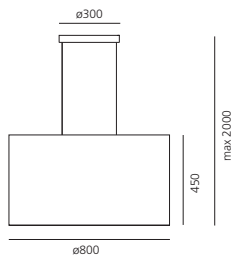
Awards2004 – Design Innovationen – Design
Zentrum Nordrhein Westfalen
Reddot Design Award
Essen (Deutschland)**Indirect emission:**
HALO max 400W (R7s)
Lamp included
Dimmable**Diffused emission:**
FLUO 4x3 RGB groups (tot. 12) x 14W (G5) – T16
Lamp included
With electronic ballast**Direct emission:**
HALO max 3x150W (B15d)
Lamp included
Dimmable

Energy Label n°41

Infrared
remote control
(included)**Materiali:** struttura in alluminio lucido con finitura a specchio; diffusore in resina termoplastica, con film traslucido finitura specchio.**Specificità:** TianXia utilizza tre sistemi luminosi per luce diretta, indiretta e diffusa.**Luce diretta:** sistema Metamorfosi, costituito da sorgenti alogene con i filtri dicroici rosso, verde e blu che consentono di ottenere infinite atmosfere di luce colorata.**Luce diffusa:** sistema RGB che produce 6 varianti di luce colorata e una di luce bianca, costituito da sorgenti fluorescenti lineari posizionate nell'intercapedine del cilindro diffusore.**Luce indiretta:** sorgente alogena. Attraverso un telecomando è possibile gestire separatamente i tre sistemi luminosi, richiamare 10 atmosfere standard, crearne e memorizzarne ulteriori 10 e agire sull'intensità luminosa.**Materials:** mirror-treated finish polished aluminium structure; thermoplastic resin diffuser with translucent film mirror-finish.**Matériaux :** structure en aluminium brillant avec finition miroir ; diffuseur en résine thermoplastique, avec film translucide finition miroir.**Materialien:** Rahmen aus hochglanzpoliertem Aluminium; Lichtverteiler aus Kunstharz mit transluzenter Folie, Oberfläche hochglanzpoliert.**Materiales:** estructura en aluminio brillante con acabado espejo; difusor en resina termoplástica, con film traslucido acabado espejo.**Specification:** Tian Xia uses three systems for direct, indirect and diffused light.**Direct light:** the Metamorfosi system, featuring halogen sources with red, green and blue dichroic filters, allows the creation of wide range of coloured light atmospheres.**Diffused light:** the RGB system, emitting 6 coloured and one white light ranges, is made of linear fluorescent sources located in the void of the cylindrical diffuser.**Indirect light:** halogen source. Using a remote control, the user can manage 10 standard atmospheres, create and save 10 more and adjust the light intensity.**Spécificité :** Tian Xia utilise trois systèmes lumineux : lumière directe, indirecte et diffuse.**Lumière directe :** Metamorfosi système, constitué de sources halogènes avec filtres dichroïques rouge, vert et bleu, permettant d'obtenir de nombreuses atmosphères de lumière colorée.**Lumière diffuse:** RGB système produisant 6 ambiances colorées et une de lumière blanche, constitué de sources fluorescentes linéaires positionnées à l'intérieur du diffuseur.**Lumière indirecte :** source halogène. A l'aide de la télécommande, il est possible de gérer 10 atmosphères standard, d'en créer et d'en mémoriser 10 autres et d'agir sur l'intensité lumineuse.**Spezifikation:** Drei Arten der Lichtverteilung: direkt, indirekt und gestreut.**Direkte Lichtverteilung:** Die Metamorfosi-Technologie, bestehend aus Halogenlampen mit dichroitischen Filtern in den Grundfarben Rot, Blau und Grün, schafft unzählige farbige Lichtstimmungen.**Gestreute Lichtverteilung:** Ein RGB-System aus Leuchtstoffröhren, die im zylindrischen Leuchtenkörper angeordnet sind, schafft 6 farbige Lichtstimmungen sowie Weißlicht.**Indirekte Lichtverteilung:** durch Einsatz von Halogenlampen. Die Lichtstimmungen sind über eine Fernbedienung abrufbar (10 Standardlichtstimmungen, 10 Einstellungen bzgl. der Lichtintensität).**Especificaciones:** Tian Xia incorpora tres sistemas luminosos para luz directa, indirecta y difusa.**Luz directa:** sistema Metamorfosi, consta de fuentes luminosas halógenas con filtros dicroicos, rojo, verde y azul, que permiten obtener infinitas atmósferas de luz coloradas.**Luz difusa:** sistema RGB, que produce 6 variantes de luz de color y una luz blanca, consta de fuentes luminosas fluorescentes lineales, que están ubicadas en el interior del cilindro difusor.**Luz indirecta:** fuente de luz halógena. Mediante un mando a distancia es posible manejar 10 atmósferas standard, crear y memorizar otras 10 y actuar en la intensidad luminosa.



Tian Xia 500 LED

design

Carlotta de Bevilacqua
2008

Patent

n. 03014108.9



Light emission

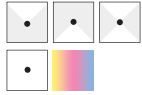

Colour



Materiali: struttura in alluminio lucido con finitura a specchio; diffusore in resina termoplastica, con film traslucido finitura specchio.
Specificità: riduce dell'80% i consumi mantenendo le prestazioni, nel segno della sostenibilità e in seguito agli sviluppi della tecnologia delle sorgenti. Utilizza tre sistemi luminosi per luce diretta, indiretta e diffusa, gestibili separatamente. In emissioni diretta e indiretta sono utilizzate sorgenti fluorescenti compatte, mentre per quella diffusa sono utilizzate strisce LED RGB, che producono 6 varianti di luce colorata e una di luce bianca.

Awards

2010 – Green Good Design Award
The Chicago Athenaeum
Chicago (US)

Materials: mirror-treated finish polished aluminium structure; thermoplastic resin diffuser with translucent film mirror-finish.

Matériaux : structure en aluminium brillant avec finition miroir ; diffuseur en résine thermoplastique, avec film translucide finition miroir.

Materialien: Rahmen aus hochglanzpoliertem Aluminium; Lichtverteiler aus Kunstharz mit transluzenter Folie, hochglanzpolierte Oberfläche.

Materiales: estructura en aluminio brillante con acabado espejo; difusor en resina termoplástica, con film traslucido acabado espejo.

Specification: following the advances in technology and sustainability, Tian Xia 500 LED allows equal performances with a 80% energy saving. It uses three systems for direct, indirect and diffused light, which can be operated separately. Compact fluorescent light sources are employed in the direct and indirect emissions, while strips of RGB LEDs are used in the diffused emission, emitting 6 coloured and one white light ranges.

Spécificité : Tian Xia 500 LED réduit la consommation énergétique de 80% tout en maintenant les performances, et ceci dans une démarche de développement durable suite à l'évolution technologique des sources. Elle utilise trois systèmes lumineux : lumière directe, indirecte et diffuse, pilotés séparément. Pour l'émission de lumière directe et indirecte, des sources fluorescentes compactes sont utilisées et, pour obtenir une lumière diffuse on emploie des LED RGB, permettant d'obtenir 6 ambiances colorées et une de lumière blanche.

Spezifikation: Als Ergebnis der stetigen Forschung im Bereich der LED-Technologie und als Zeichen der Nachhaltigkeit reduziert die Tian Xia 500 LED den Energieverbrauch bei gleich bleibender Lichtleistung um 80%. Drei unabhängige Steuerungssysteme für die direkte, indirekte und gestreute Lichtverteilung. Die direkte und indirekte Lichtsteuerung erfolgen über Kompaktleuchtstofflampen, die gestreute Lichtverteilung über LED-RGB (6 farbige Lichtstimmungen sowie Weißlicht).

Especificaciones: Tian Xia 500 LED reduce un 80% los consumos, manteniendo al mismo tiempo, las prestaciones, en un signo de la sostenibilidad y la raíz de los acontecimientos en la tecnología de fuentes de luz. Incorpora tres sistemas luminosos para luz directa, indirecta y difusa, gestionados separadamente. Para la emisión directa e indirecta se utilizan fuentes de luz fluorescentes compactas, mientras para la emisión difusa se utilizan fuentes de luz LED RGB, que permiten obtener 6 variantes de luz de color y una luz blanca.

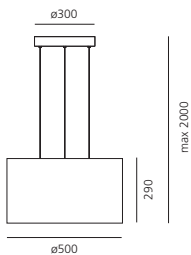

Indirect emission:

FLUO 2x42W (GX 24q-4) – TC-TEL
Lamp included
With electronic ballast
Dimmable

Diffused emission:
LED 35W RGB

Direct emission:

FLUO 1x42W (GX 24q-4) – TC-TEL
Lamp included
Dimmable

IP20 EAC

Energy Label n°26



Infrared remote control
(included)





Nur

design

Ernesto Gismondi

Serie di lampade a sospensione disponibili in diverse versioni.

3 dimensioni: Nur (ø diffusore 55 cm), Nur 1618 (ø diffusore 90 cm) e Nur Mini (ø diffusore 36 cm)

2 sorgenti luminose: LED e alogena

5 finiture: alluminio anodizzato e grigio, antracite, gloss bianco e gloss nero.

Range of suspension lamps available in many versions.
3 sizes: Nur (diffuser ø 55 cm), Nur 1618 (diffuser ø 90 cm), and Nur Mini (diffuser ø 36 cm).
2 lighting sources: LED and Halogen.
5 finishing: Aluminium anodized and grey, anthracite, white gloss and black gloss.

Série de suspensions disponibles dans de nombreuses versions.
3 tailles : Nur (diffuseur ø 55 cm), Nur 1618 (diffuseur ø 90 cm), et Nur Mini (diffuseur ø 36 cm).
2 sources lumineuses : LED et Halogène.
5 finitions : Aluminium anodisé et gris, anthracite, blanc ou noir brillant.

Vielfältige Familie von Pendelleuchten.
3 Größen: Nur (Schirm ø55 cm), Nur 1618 (Schirm ø90 cm), Nur mini (Schirm ø36 cm).
2 Bestückungsvarianten: LED, Halogen-.
5 Farben/Oberflächen: Eloxiertem Aluminium und Grau, Anthrazit, Weiß glänzend und Schwarz glänzend.

Serie de lámparas de suspensión disponibles en distintas versiones.
3 dimensiones: Nur (ø difusor 55 cm), Nur 1618 (ø difusor 90 cm) y Nur Mini (ø difusor 36 cm).
2 fuentes de luz: LED y Halógena.
5 acabados: aluminio anodizado y gris, antracita, gloss blanca y gloss negra.

Nur 1618

Nur

Nur Mini

LED



Halogen



Nur 1618

Nur

Nur mini



Nur
Nur 1618
Nur mini

design

Ernesto Gismondi
2003, 2005, 2006



Light emission



Colours

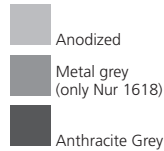

Materiali: corpo lampada in alluminio, calotta superiore in vetro borosilicato sabbato.

Specificità: disponibile come accessorio una cupola antiabbagliamento, e, solo per la versione NUR 1618 Halo, anche un filtro colorato.

Awards

2004 – Design Innovationen
Design Zentrum Nordrhein Westfalen
Reddot Design Award
Essen (Deutschland)

Materials: aluminium body lamp; upper cap in borosilicate sanded glass.

Matériaux : corps en aluminium; calotte supérieure en verre borosilicate sablé.

Materialien: Leuchtenkörper aus Aluminium; obere Kappe aus sandgestrahltem Borosilikatglas.

Materiales: cuerpo de la lámpara en aluminio; campana superior en cristal borosilicado arenado.

Specification: available accessories are anti-dazzle screen and coloured filter for Nur 1618 Halo.

Spécificité : un écran anti-éblouissant est disponible en option et, un écran anti-éblouissant et un filtre coloré sont disponibles pour la version Nur 1618 Halo.

Spezifikation: Entblendungsschirm sowie Farbfilter für Nur Halo und Nur Halo als Zubehör erhältlich.

Especificaciones: la cúpula antideslumbramiento es opcional y para las versiones halógena un filtro de color.

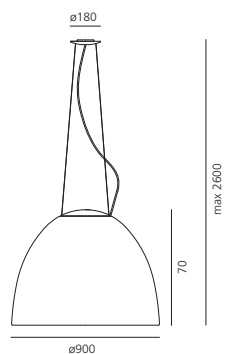

Nur 1618 LED

LED Total power 95W
Color temperature 3000K
Lighting output 3546lm
Dimmable

IP20 ENEC

Energy Label n°1

Nur 1618 Halo

HALO max 2x400W (R7s)
Lamp included
Dimmable

IP20 ENEC

Energy Label n°4

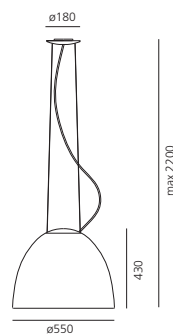

Nur LED

LED Total power 45W
Color temperature 2700K
Lighting output 2013lm
Dimmable

IP20 ENEC

Energy Label n°1

Nur Halo

HALO max 1x205W (E 27)
Lamp included
Dimmable

IP20 ENEC

Energy Label n°6

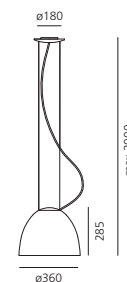

Nur Mini LED

LED Total power 30W
Color temperature 2700K
Lighting output 1396lm
Dimmable

IP20 ENEC

Energy Label n°1

Nur Mini Halo

HALO max 1x160W (R7s)
Lamp included
Dimmable

IP20 ENEC

Energy Label n°5



Coloured filter
(Only for Nur 1618 Halo)



Anti-dazzle screen
(Only for Nur 1618 Halo)



Autogrill Fiera Milano, Ph. Saverio Lombardi Vallauri



Nur gloss

Nur gloss mini

design

Ernesto Gismondi
2008, 2009

Light emission



Colours

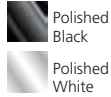

Materiali: corpo lampada in alluminio verniciato; diffusore in materiale termoplastico; calotta superiore in vetro borosilicato sabbato.
Specificità: una finitura perfettamente liscia e lucida conferisce eleganza al classico modello Nur. Tutte le versioni sono chiuse da un diffusore nella parte inferiore.

Materials: painted aluminium body lamp; diffuser in thermoplastic material; upper cap in borosilicate sanded glass.

Matériaux : corps en aluminium verni ; diffuseur en matériau thermoplastique ; calotte supérieure en verre borosilicate sablé.

Materialien: Körper aus lackiertem Aluminium; Schirm aus thermoplastischem Material; obere Abdeckung aus sandgestrahltem Borosilikatglas.

Materiales: cuerpo de aluminio pintado, difusor de material termoplástico, campana superior en cristal borosilicado arenado.

Specification: a perfectly smooth and polished finish adding that extra touch of elegance to the classic Nur model. All versions feature a screen on the bottom part of the shade.

Spécificité : une nouvelle finition parfaitement lisse et brillante donne plus d'élégance au modèle Nur classique. Toutes les versions sont fermées par un diffuseur dans la partie inférieure.

Spezifikation: Die neue Hochglanzpolitur verleiht dem Klassiker Nur eine besondere Eleganz. Alle Ausführungen sind mit einem an der Unterseite des Schirms angebrachten Diffusor versehen.

Especificaciones: un nuevo acabado perfectamente liso y brillante confiere elegancia al clásico modelo Nur. Todas las versiones están cerradas por un difusor en la parte inferior.

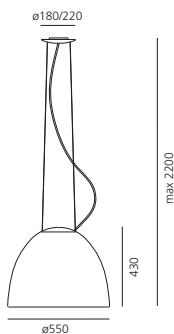
**Nur gloss LED**

LED Total power 45W
Color temperature 2700K
Lighting output 2145lm
Dimmable



Energy Label n°1

Nur gloss Halo

HALO max 1x205W (E27)
Dimmable

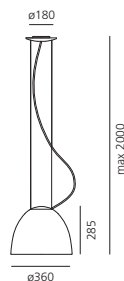

Energy Label n°6

**Nur gloss mini LED**

LED Total power 30W
Color temperature 2700K
Lighting output 1396lm
Dimmable



Energy Label n°1

Nur gloss mini Halo

HALO max 1x150W (E27)
Dimmable



Energy Label n°6

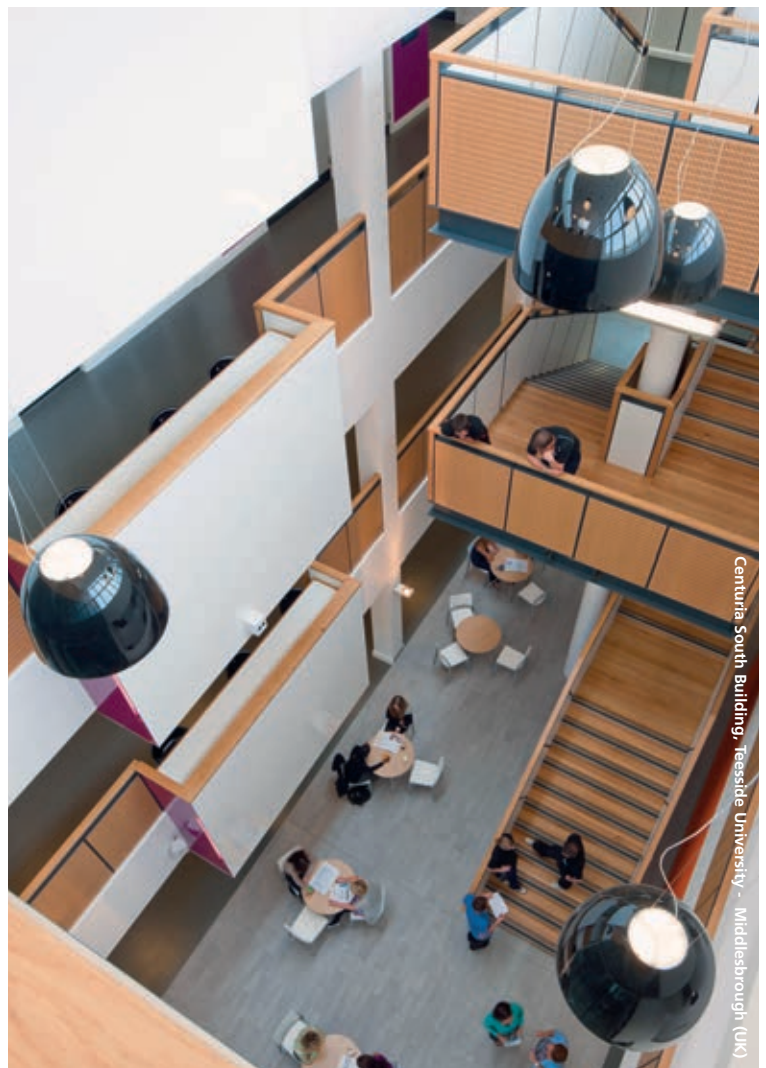

Centuria South Building, Teesside University - Middlesbrough (UK)

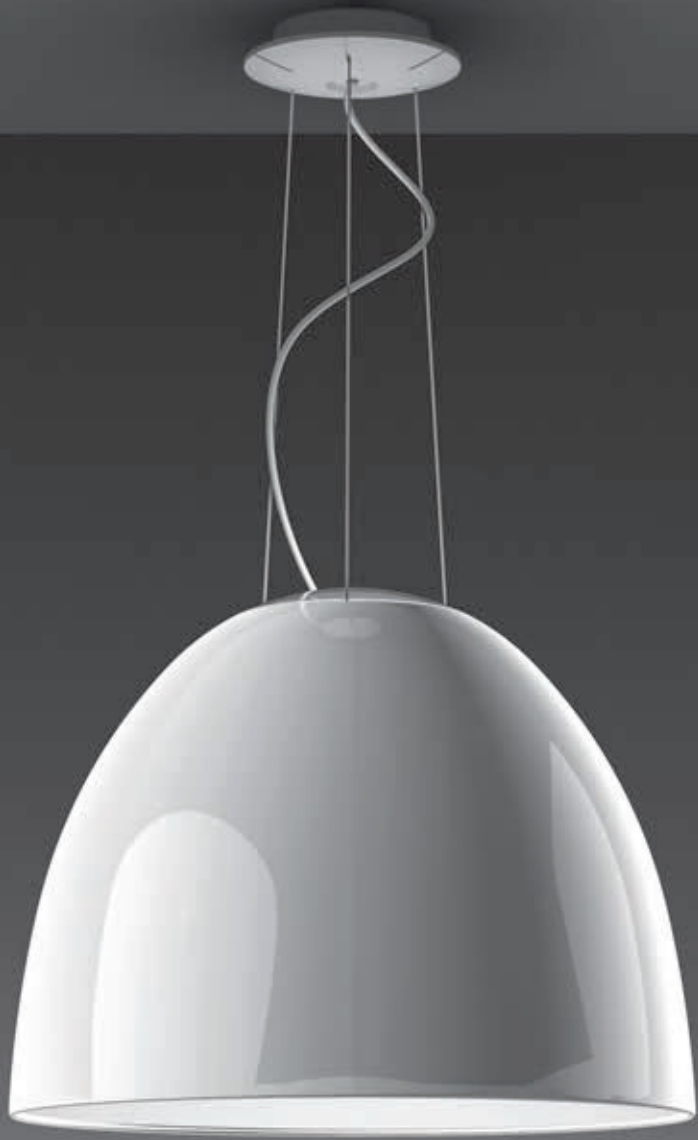

Nur gloss

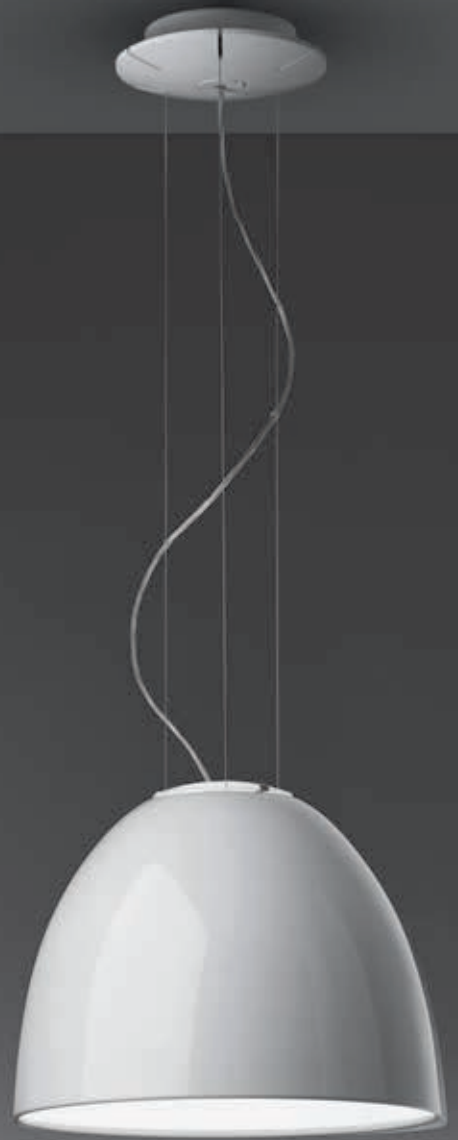

Nur gloss mini



Talo 90 sospensione
Talo 120 sospensione
Talo 150 sospensione
Talo 180 sospensione
Talo 240 sospensione

design

Neil Poulton
2001

Light emission



Colours



White



Silver Grey

Awards

2002 – Prix “L’Observateur du Design 2002”
“Etoile 2002” – Paris (France)
2002 – Design Innovationen – Design
Zentrum Nordrhein Westfalen
Reddot Design Award
Essen (Deutschland)
2002 – iF Product Design Award
Hannover (Deutschland)
2002 – Compasso d’Oro / A.D.I.
– Selezione, Milano (Italia)
2003 – Intel Design
Categoria design “Augusto Morello”
III edizione – Milano (Italia)

Materiali: rosone in resina termoplastica; corpo in alluminio verniciato; diffusore inferiore in policarbonato opalino.
Specificità: disponibile monotubo o bitubo in linea in diverse lunghezze a seconda della sorgente impiegata. I cavetti di sospensione svolgono anche funzione di alimentazione.

Materials: thermoplastic resin ceiling rose; painted aluminium body; opal polycarbonate lower diffuser.

Specification: available mono or double tube (on the same line), in different lengths according to the power of the light source. The suspension cables are also feed cables.

Matériaux : rosace en résine thermoplastique ; corps en aluminium verni ; diffuseur inférieur en polycarbonate opalin.

Spécificité : disponible en version mono ou bitube (en ligne) en différentes longueurs selon la puissance de la source lumineuse. Les 4 câbles servent également de câbles d'alimentation.

Materialien: Rosette aus Kunststoff; Körper aus lackiertem Aluminium; unterer Schirm aus opalem Polycarbonat.

Spezifikation: In 1- oder 2-lampiger Ausführung (lineare Anordnung) und verschiedenen Größen (in Abhängigkeit des eingesetzten Leuchtmittels) erhältlich. Die Seilzüge dienen als Aufhängung und Stromversorgung.

Materiales: rosetón en resina termoplástica; cuerpo en aluminio pintado; difusor inferior en policarbonato opalino.

Especificaciones: disponible en versión mono o doble tubo (en línea), en longitudes diferentes según la potencia de la fuente luminosa. Los cables desarrollan también la función de alimentación.

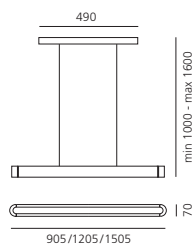

Talo 90 sospensione LED

LED Total power 33W
Color temperature 3000K
Lighting output 3175lm
Not dimmable or Dimmable

IP20 EAC

Energy Label n°1

Talo 120 sospensione LED

LED Total power 52W
Color temperature 3000K
Lighting output 4648lm
Not dimmable or Dimmable

IP20 EAC

Energy Label n°1

Talo 150 sospensione LED

LED Total power 65W
Color temperature 3000K
Lighting output 5869lm
Not dimmable or Dimmable

IP20 EAC

Energy Label n°1

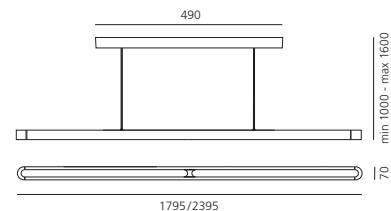

Talo 180 sospensione Fluo

FLUO 2x39W (G5)
Lamp included
With electronic ballast
Not dimmable or Dimmable

IP20 EAC

Energy Label n°23

Talo 90 sospensione Fluo

FLUO 1x39W (G5)
Lamp included
With electronic ballast
Not dimmable or Dimmable

IP20 EAC

Energy Label n°23

Talo 120 sospensione Fluo

FLUO 1x54W (G5)
Lamp included
With electronic ballast
Not dimmable or Dimmable

IP20 EAC

Energy Label n°23

Talo 150 sospensione Fluo

FLUO 1x80W (G5)
Lamp included
With electronic ballast
Not dimmable or Dimmable

IP20 EAC

Energy Label n°23

Talo 240 sospensione Fluo

FLUO 2x54W (G5)
Lamp included
With electronic ballast
Not dimmable or Dimmable

IP20 EAC

Energy Label n°23



Light emission



Colour



White

Awards

Float circolare

2001 – Compasso d'Oro / A.D.I. – Segnalazione
Milano (Italia)

Materiali: struttura in alluminio verniciato; diffusore inferiore in metacrilato opalino; diffusore superiore in policarbonato trasparente.
Specificità: disponibile nelle versioni circolare o lineare.
È possibile applicare un filtro blu o topazio all'emissione indiretta (solo nella versione circolare).

Materials: structure in painted aluminium, lower diffuser in opaline methacrylate, upper diffuser in transparent polycarbonate.

Specification: available in circular or linear versions. Application of a coloured filter, blue or topaz, to the indirect light emission (Float circolare only).

Matériaux : structure en aluminium verni, diffuseur inférieur en méthacrylate opalin, diffuseur supérieur en polycarbonate transparent.

Spécificité : disponible en version circulaire ou linéaire. Un filtre coloré (bleu ou topaze) peut être ajouté, à l'émission indirecte (seulement pour Float circulaire).

Materialien: Struktur aus lackiertem Aluminium; unterer Schirm aus opalem Metacrylat; oberer Schirm aus transparentem Polycarbonat.

Spezifikation: Erhältlich als Kreis- oder Linearausführung. Für die Versionen Float circolare ist der Einsatz eines blauen oder goldgelben Farbfilters möglich.

Materiales: estructura de aluminio pintado; difusor inferior de metacrilato opalino, difusor superior en metacrilato transparente.

Especificaciones: disponible en dos versiones: linear o circular. Es posible aplicar un filtro azul o topacio para la emisión de luz indirecta (sólo en la version circular).

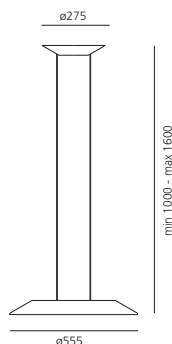

Float circolare sospensione

FLUO 1x55W (2GX 13) – T 16-R
Lamp included
With electronic ballast
Not dimmable



Energy Label n°28

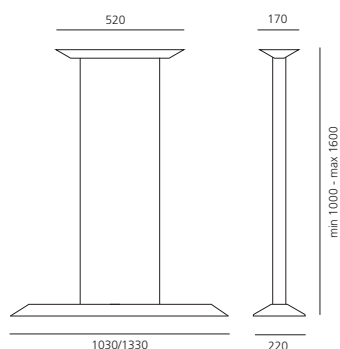

Float lineare sospensione

FLUO 2x39W (G 5) – T 16
Light included
With electronic ballast
Not dimmable



Energy Label n°23

FLUO 2x54W (G 5) – T 16
Light included
With electronic ballast
Not dimmable



Energy Label n°23



Float circolare sospensione



Coloured filter for
Float circolare only



Empatia 16 sospensione
Empatia 26 sospensione
Empatia 36 sospensione

design

Carlotta de Bevilacqua
Paola di Arianello
2013



Light emission



Colours



White

Materiali: diffusore in vetro soffiato trasparente con finitura seta lucida; guida luce in metacrilato a basso coefficiente di assorbimento; corpo della lampada in alluminio pressofuso con finitura verniciata; rosone in tecnopolimero.

Awards

2014 – Wallpaper Design Awards
2014 – iF Product Design Award

Materials: diffuser in blown glass with a polished-silk finish; light pipe made of low absorption coefficient methacrylate; painted die-cast aluminium body lamp; ceiling rose in technopolymer.

Matériaux : diffuseur en verre soufflé transparent avec finition soie brillante ; corps en aluminium moulé sous pression peint; guide lumière en méthacrylate à bas coefficient d'absorption ; rosace en techno-polymère.

Materialien: Schirm aus transparentem, mundgeblasenem Glas in seidig glänzendem Finish; Lichtstab aus Methacrylat mit niedrigem Absorptionskoeffizienten; Leuchtenkörper aus druckgegossenem, lackiertem Aluminium; Deckenbaldachin aus Technopolymer.

Materiales: difusor en cristal soplado transparente con acabado seda lúcido; guía de luz en metacrilato de bajo coeficiente de absorción; cuerpo de la lámpara en aluminio fundido a presión y pintado; plancha de fijación a techo en polímero.



min 500 - max 2000

Empatia 16 sospensione

LED Total power 11W
Color temperature 3000K
Lighting output 530lm
Not dimmable



Energy Label n°1



ø160



min 500 - max 2100

Empatia 26 sospensione

LED Total power 16W
Color temperature 3000K
Lighting output 710lm
Not dimmable



Energy Label n°1



ø260



min 500 - max 2200

Empatia 36 sospensione

LED Total power 24W
Color temperature 3000K
Lighting output 1189lm
Not dimmable



Energy Label n°1

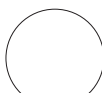

ø360

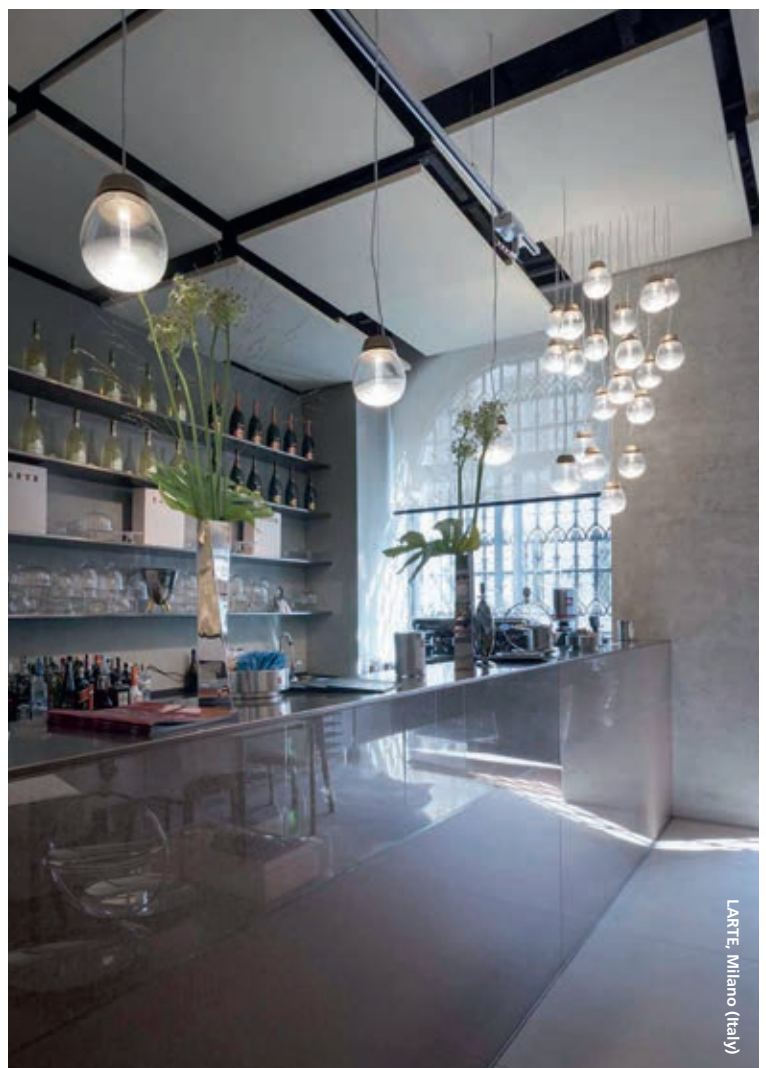



Empatia 16



Empatia 36



Empatia 26

Meteorite 15 sospensione
Meteorite 35 sospensione

design
Pio & Tito Toso
2014



Light emission



Colour



White

Materiali: diffusore in vetro soffiato; corpo della lampada e rosone in tecnopolimero.

Materials: blown glass diffuser; lamp body and ceiling rose in technopolymer.

Matériaux : diffuseur en verre soufflé ; corps et rosace en techno-polymère.

Materialien: Schirm aus mundeblasenem Glas; Leuchtenkörper und Deckenbaldachin aus Technopolymer.

Materiales: difusor en cristal soplado, cuerpo de la lámpara y plancha de fijación a techo en tecnopolímero.

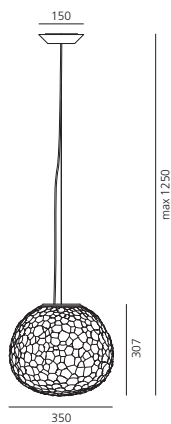

Meteorite 15 sospensione

HALO max 1x48W (G9)
Lamp included
Dimmable



Energy Label n°18

Meteorite 35 sospensione

HALO max 150W (E27)
Dimmable



Energy Label n°4



Off

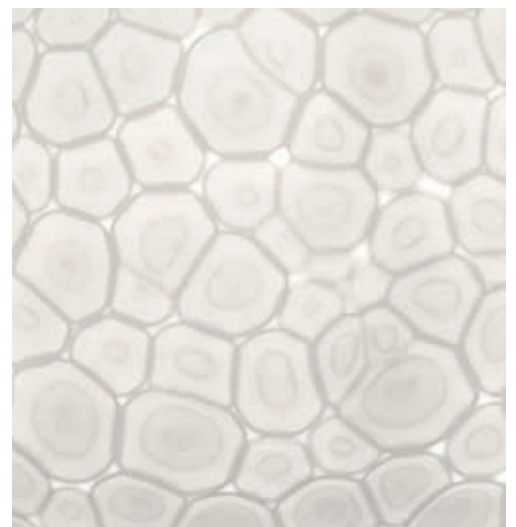

On



Meteorite 15

Meteorite 35

Laguna 16 sospensione
Laguna 26 sospensione
Laguna 37 sospensione

design

Matteo Thun
Antonio Rodriguez
2013



Light emission



Colour



White

Materiali: stelo in acciaio verniciato nero (black brown); diffusore in vetro soffiato; rosone in tecnopolimero.

Materials: stem in black painted extruded Aluminium; diffuser in blown glass; ceiling rose in white painted plastic; ceiling rose in technopolymer.

Matériaux : tige en aluminium verni noir (noir brun), diffuseur en verre soufflé ; rosace blanche en plastique verni; rosace en techno-polymère.

Materialien: stab aus schwarz-braun lackiertem fließgepresstem Aluminium; Schirm aus mundgeblasenem Glas; Deckenbaldachin aus Technopolymer.

Materiales: base en aluminio barnizado negro (black brown); difusor en cristal soplado; rosetón blanco en plástico pintado; plancha de fijación a techo en polímero.

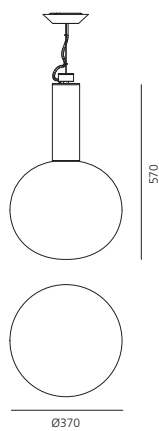

Laguna 16

LED Total power 15W
Color temperature 3000K
Lighting output 539lm
Not dimmable

IP20

Energy Label n°1

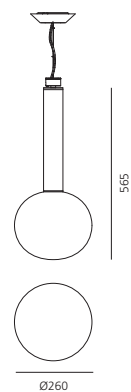

Laguna 26

LED Total power 20W
Color temperature 3000K
Lighting output 1211lm
Not dimmable

IP20

Energy Label n°1

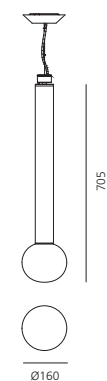

Laguna 37

LED Total power 28W
Color temperature 3000K
Lighting output 1881lm
Not dimmable

IP20

Energy Label n°1





Laguna 26

Laguna 37

Laguna 16

Castore 14 sospensione
 Castore 25 sospensione
 Castore 35 sospensione
 Castore 42 sospensione

design

Michele De Lucchi
 Huub Ubbens
 2003



Light emission



Colour



White

Materiali: rosone e stelo in resina termoplastica; diffusore in vetro soffiato.

Awards

2004 – Design Plus, light + building
 Frankfurt am Main (Deutschland)

2004 – Design Innovationen
 Design Zentrum Nordrhein Westfalen
 Reddot Design Award
 Essen (Deutschland)

2004 – Compasso d'Oro / A.D.I. – Segnalazione
 Milano (Italia)

Materials: ceiling rose
 and stem in thermoplastic
 resin; blown glass diffuser.

Matériaux : tige et rosace
 en résine thermoplastique ;
 diffuseur en verre soufflé.

Materialien: Deckenrosette
 und Stab aus thermoplasti-
 schem Harz; Schirm
 aus mundgeblasenem Glas.

Materiales: florón y cuerpo
 en resina termoplástica;
 difusor en cristal soplado.

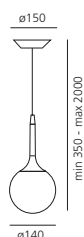

Castore 14 sospensione

HALO max 1x48W (G9)
 Lamp included
 Dimmable



Energy Label n°18

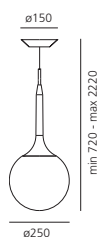

Castore 25 sospensione

HALO max 1x100W (E27)
 Dimmable
 or FLUO 1x15W (E27) – TC-TSE
 or LED max 1x14,5W (E27)



Energy Label n°6

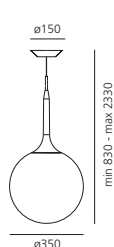

Castore 35 sospensione

HALO max 1x150W (E27)
 Dimmable
 or FLUO 1x23W (E27) – TC-TSE
 or LED max 1x17W (E27)



Energy Label n°6

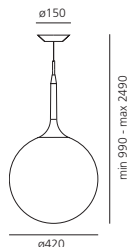

Castore 42 sospensione

HALO max 1x150W (E27)
 Dimmable
 or FLUO 1x23W (E27) – TC-TSE
 or LED max 1x17W (E27)



Energy Label n°6





Castore 42

Castore 25

Castore 14

Castore 35

Castore calice 18 sospensione
Castore calice 42 sospensione

design

Michele De Lucchi
Huub Ubbens
2004



Light emission



Colour



White

Materiali: rosone e stelo in resina termoplastica; diffusore in vetro soffiato.
Specificità: il diffusore della versione 42 è chiuso inferiormente.

Materials: ceiling rose and stem in thermoplastic resin; blown glass diffuser.

Matériaux : base en zamac, tige en résine thermoplastique ; diffuseur en verre soufflé.

Materialien: Deckenrosette und Stab aus thermoplastischem Harz; Schirm aus mundgeblasenem Glas.

Materiales: florón y varilla en resina termoplástica, difusor en cristal soplado.

Specification: the diffuser of Castore Calice 42 feature a screen on the bottom part of the glass.

Spécificité: le diffuseur de la version 42 est fermé dans la partie inférieure.

Spezifikation: Der Schirm der Ausführung Castore Calice 42 ist unten geschlossen.

Especificaciones: el difusor de la versión 42 viene con la parte inferior cerrada.

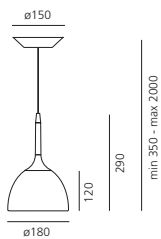

Castore calice 18 sospensione

HALO max 1x48W (G9)
Lamp included
Dimmable



Energy Label n°18

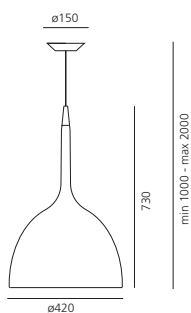

Castore calice 42 sospensione

HALO max 1x205W (E27)
Dimmable
or FLUO 1x23W (E27) – TC-TSE
or LED max 1x17W (E27)



Energy Label n°6



Castore calice 18 sospensione

Castore calice 42 sospensione

Light emission



Colour



White

Materiali: rosone in resina termoplastica; diffusore in materiale termoplastico.

Materials: ceiling rose in thermoplastic resin; diffuser in thermoplastic material.

Matériaux : rosace en résine thermoplastique ; diffuseur en matériau thermoplastique.

Materialien: Rosette aus Kunsthartz; Schirm aus thermoplastischem Material.

Materiales: rosetón, de resina termoplástica; difusor en material termoplástico.

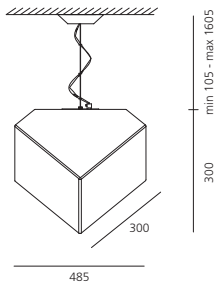

FLUO 1x23W (E 27) – TC-TSE

Not dimmable

IP20  EAC

Energy Label n°9



Light emission



Colours



Rod:
Mirror



Diffuser:
Transparent

Awards

1998 – BIO 16 – Selection
Ljubljana (Slovenia)

Materiali: tige in metallo cromato lucido; diffusore in vetro soffiato trasparente.

Specificità: tige adattabile alle diverse altezze dei soffitti.

Materials: metal rode, diffuser in transparent blown glass.

Matériaux : tige en métal chromé brillant ; diffuseur en verre soufflé transparent.

Materialien: Gestell aus verchromtem und poliertem Metall, Schirm aus klarem, mundeblasenem Glas.

Materiales: varilla, de metal cromado brillante; difusor en cristal soplado transparente.

Specification: adjustable rod for different ceiling heights;

Spécificité : tige adaptable aux différentes hauteurs de plafond.

Spezifikation: Das Kabel ist für unterschiedliche Deckenhöhen justierbar.

Especificaciones: varilla se regula con arreglo a la altura del techo.

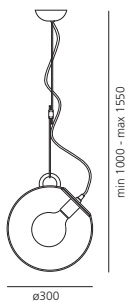

FLUO max 1x23W (E27) – globe ø cm 12
Not dimmable



Energy Label n°9





Logico sospensione
 Logico mini sospensione
 Logico micro sospensione
 Logico nano sospensione

design

Michele De Lucchi
 Gerhard Reichert
 2001, 2002, 2003, 2006



Light emission



Colour



White

Materiali: struttura in metallo verniciato; diffusore in vetro soffiato con finitura seta lucida. Soffiatura a tre strati (cristallo + effetto seta + cristallo) in stampo a fermo con forma capovolta per garantire solidità strutturale del vetro.

Specificità: disponibile in quattro dimensioni e in quattro configurazioni: singola, in linea, 3x120° e 4x90°. La forma modulare si presta alla componibilità e alla realizzazione di combinazioni personalizzate, fornite come progetto speciale.

Awards

Logico sospensione

2002 – Design Innovationen – Design Zentrum Nordrhein Westfalen
 Reddot Design Award
 Essen (Deutschland)

Logico sospensione micro

2004 – Design Plus, light + building
 Frankfurt am Main (Deutschland)

Materials: painted metal structure, blown glass diffuser with a polished-silk finish. Three layers of glass (crystal + silk + crystal) are blown in an upside down mould to ensure structural consistence to glass.

Specification: available in four sizes and four configurations: single, in line, 3x120° and 4x90°. Its modular shape allows the creation of customized configurations, supplied as special products.

Matériaux : structure en métal verni ; diffuseur en verre soufflé, finition soie brillante. Verre soufflé en trois couches (cristal + effet soyeux + cristal) dans un moule qui a une forme inversée pour garantir la solidité structurale du verre.

Spécificité : disponible en quatre tailles et en quatre configurations : simple, en ligne, 3x120° et 4x90°. Sa forme modulaire, permet de nombreuses combinaisons capables de produire autant de compositions personnalisées, produit spécial à définir pour tout projet.

Materialien: Rahmen aus lackiertem Metall; Schirm aus geblasen- em Glas in seidig geblasenem Finish. Drei Glasschichten (Kristall + Seide + Kristall) die umgekehrt positioniert sind um die Stabilität des Glases zu gewährleisten.

Spezifikation: Erhältlich in vier Größen und in vier Ausführungen: Einzel, in Linie, 3x120° und 4x90°. Eine individuelle Anordnung der Leuchtenmodule ist auf Wunsch als Sonderleuchte möglich.

Materiales: estructura de metal pintado; difusor de cristal soplado con acabado de seda brillante. Soplado a tres capas (cristal + efecto seda + cristal) en un molde con forma invertida para asegurar la resistencia estructural del cristal.

Especificaciones: disponible, en cuatro tamaños y en cuatro configuraciones: individual, en línea, 3x120° y 4x90°. Su forma modular, se presta para realizar combinaciones personalizadas, entrega como proyecto especial.





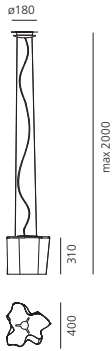

Logico sospensione

HALO max 1x105W (E27)
Dimmable
or FLUO 1x23W (E27) – TC-TSE
or **LED** max 1x17W (E27)



Energy Label n°6

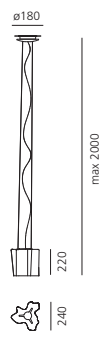

Logico mini sospensione

HALO max 1x77W (E27)
Dimmable



Energy Label n°6



Logico micro sospensione

HALO max 1x46W (E14)
Dimmable
or FLUO max 1x8W (E14)
or **LED** max 1x4,5W (E14)



Energy Label n°30



Logico nano sospensione

HALO max 1x46W (E14)
Dimmable



Energy Label n°30

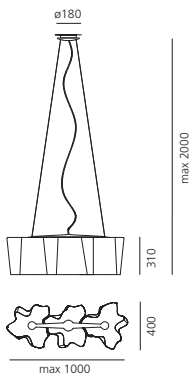

Logico sospensione 3 in linea

HALO max 3x105W (E27)
Dimmable
or FLUO 3x23W (E27) – TC-TSE
or **LED** max 3x17W (E27)



Energy Label n°6

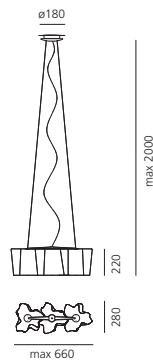

Logico mini sospensione 3 in linea

HALO max 3x77W (E27)
Dimmable



Energy Label n°6

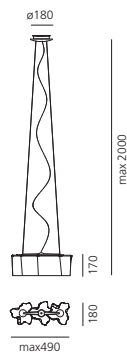

Logico micro sospensione 3 in linea

HALO max 3x46W (E14)
Dimmable
or FLUO max 3x8W (E14)
or **LED** max 3x4,5W (E14)



Energy Label n°30

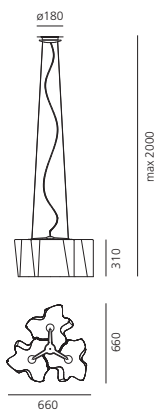

Logico sospensione 3x120°

HALO max 3x105W (E27)
Dimmable
or FLUO 3x23W (E27) – TC-TSE
or **LED** max 3x17W (E27)



Energy Label n°6

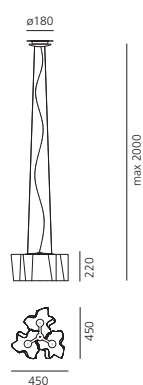

Logico mini sospensione 3x120°

HALO max 3x77W (E27)
Dimmable



Energy Label n°6

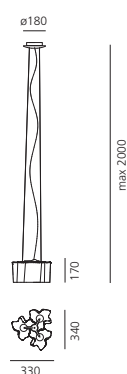

Logico micro sospensione 3x120°

HALO max 3x46W (E14)
Dimmable
or FLUO max 3x8W (E14)
or **LED** max 3x4,5W (E14)



Energy Label n°30

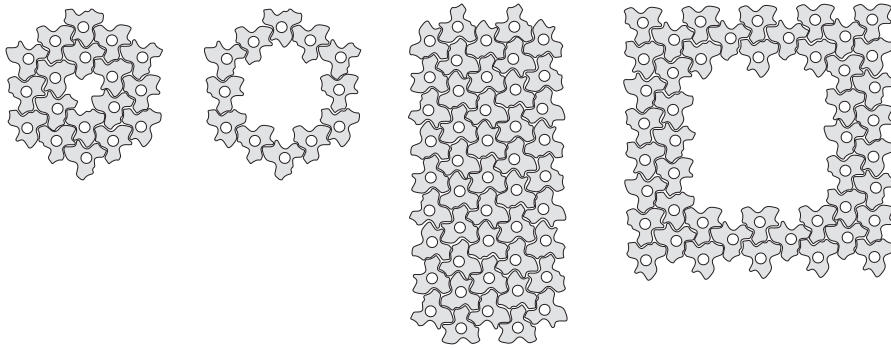

Only for custom projects – which feasibility must be approved by Artemide technical design department – it's possible to create different combinations by joining the elements Logico sospensione.

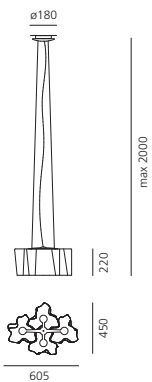

Logico mini sospensione 4x90°

HALO max 4x77W (E27)
Dimmable
or FLUO max 4x8W (E27)
or LED max 4x4,5W (E27)



Energy Label n°6

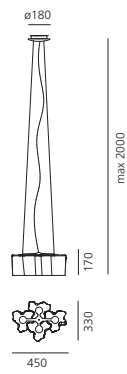

Logico micro sospensione 4x90°

HALO max 4x46W (E14)
Dimmable
or FLUO max 4x8W (E14)
or LED max 4x4,5W (E14)



Energy Label n°30



Logico sospensione 3x120°



Logico sospensione mini 4x90°

Droplet sospensione

design

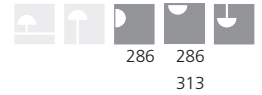
Ross Lovegrove
2007, 2011

Light emission



Colours



Materiali: corpi luminosi in alluminio pressofuso; riflettore in alluminio stampato e verniciato.

Museum

2011 – Design Museum
Habitare collection 2011,
Helsinki (Finland)

Materials: die-cast aluminium lighting units; painted die-cast aluminium reflector.

Matériaux : corps lumineux en aluminium moulé sous pression. Réflecteur en aluminium moulé et verni.

Materialien: Leuchtenkörper aus druckgegossenem Aluminium; Reflektor aus formgestanztem Aluminium.

Materiales: cuerpos luminosos en aluminio fundido a presión; reflector en aluminio moldeado y pintado.

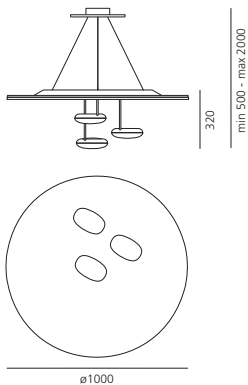
**Droplet sospensione LED**

LED Total power 3x29W
Color temperature 3000K
Lighting output 3x2330lm
Dimmable



Energy Label n°1

Droplet sospensione Halo

HALO max 3x160W (R7s)
Lamp included
Dimmable



Energy Label n°5





Mercury sospensione

Mercury mini sospensione

design

Ross Lovegrove
2007, 2012



314

Light emission



Colours



Materiali: corpi luminosi in alluminio pressofuso; corpi riflettenti in materiale termoplastico stampato ad iniezione con finitura metallizzata; riflettore in acciaio inox.

Awards

Mercury sospensione:

2008 – Reddot Design Award
"Best of the Best", Essen (Deutschland)
2008 – Good Design Award
The Chicago Atheneum, Chicago (US)

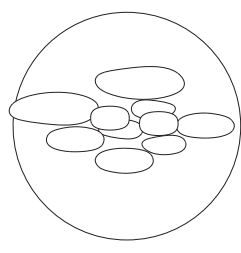
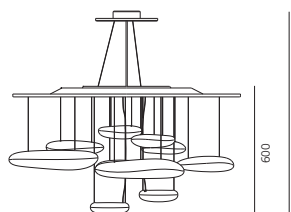

ø1100

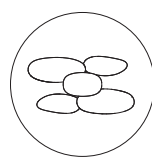
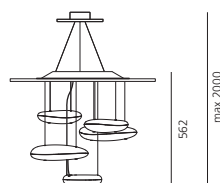

ø700

Mercury sospensione LED

LED Total power 2x29W
Color temperature 3000K
Lighting output 2x2330lm
Dimmable



Energy Label n°1

Mercury mini sospensione LED

LED total power 1x29W
Color temperature 3000K
Lighting output 2330lm
Dimmable



Energy Label n°1

Mercury sospensione Halo

HALO max 2x160W (R7s)
Lamp included
Dimmable



Energy Label n°5

Mercury mini sospensione Halo

HALO 1x160W (R7s)
Lamp included
Dimmable



Energy Label n°5



Mercury sospensione





Materials: die-cast aluminium lighting units; reflective units made of injection-moulded thermoplastic material with metallic finish; stainless steel reflector.

Matériaux : corps lumineux en aluminium moulé sous pression. Galets réfléchissants en matériau thermoplastique finition métallisée. Réflecteur en acier inoxydable.

Materialien: Leuchtenkörper aus druckgegossenem Aluminium; reflektierende Körper aus Spritzguss-Thermoplast mit Metallic-Oberfläche; Reflektor aus Edelstahl.

Materiales: cuerpos luminosos en aluminio fundido a presión; cuerpos reflectantes en material termoplástico moldeado por inyección, con acabado metalizado; reflector en acero inoxidable.

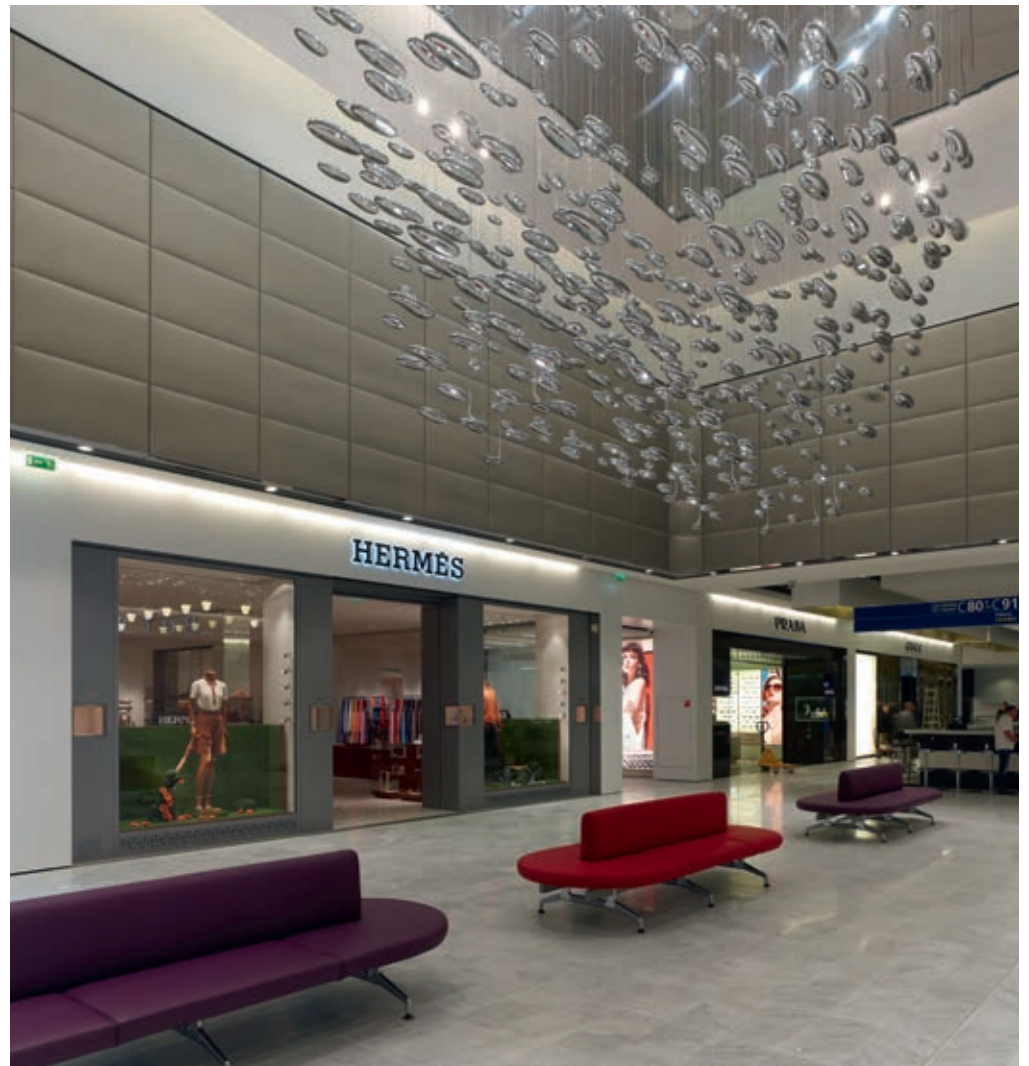
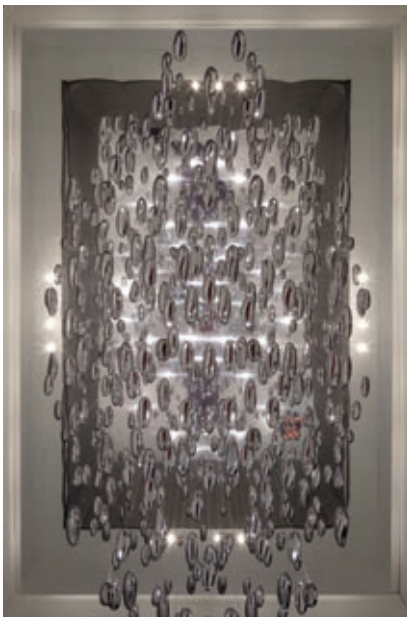

Custom projects
National Theatre, Baku (AZ)
Architectural project: Ragim Seyfullayev
Ph: Khalid Ahmadov

Roissy Charles de Gaulle Airport, Paris (FR)
Architectural project: Marc Fidelle
Ph: Didier Boy de la Tour

Cosmic Angel sospensione

design

Ross Lovegrove
2009



Light emission



Colours



Mirror

Materiali: corpo lampada-riflettore in materiale termoplastico.
Corpi illuminanti in alluminio pressofuso.

Materials: body lamp-reflector made of thermo-plastic material; die-cast aluminium lighting units.

Matériaux : corps-réfecteur en matériau thermoplastique ; corps lumineux en aluminium moulé sous pression.

Materialien: Leuchtenkopf aus thermoplastischem Material; Leuchtenkörper aus druckgegossenem Aluminium.

Materiales: cuerpo de la lámpara-reflector en material termoplástico. Cuerpo luminoso en aluminio fundido.

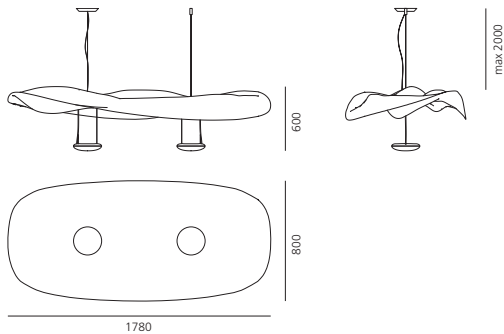

Cosmic Angel Halo

HALO max 2x400W (R7s)
Lamp included
Dimmable



Energy Label n°5

Cosmic Angel HIT

METAL HALIDE 2x70W (G8,5) – HIT
Lamp included
With electronic ballast
Not dimmable



Energy Label n°23



Vodafone Headquarters, Milan (IT)



Light emission



Colours

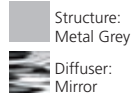

Materiali: struttura in alluminio pressofuso; diffusore in alluminio stampato e trattato a specchio.

Materials: die-cast aluminium structure; moulded and mirror-treated aluminium diffuser.

Matériaux : structure en aluminium moulé sous pression ; diffuseur en aluminium moulé et traité façon miroir.

Materialien: Struktur aus druckgegossenem Aluminium; Lichtverteiler aus Spritzguss und hochglanzpoliertem Aluminium.

Materiales: estructura en aluminio fundido a presión; difusor en aluminio moldeado por inyección con acabado pulido espejo.

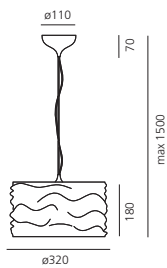

HALO max 1x150W (E27)
Dimmable



Energy Label n°6



Light emission



Colour



White

Materiali: corpo lampada in alluminio pressofuso verniciato.
Specificità: i cavetti di sospensione fungono anche da alimentazione.

Materials: body lamp in painted die-cast aluminium.

Matériaux : corps en aluminium moulé sous pression peint.

Materialien: Leuchtenkörper aus druckgegossenem, lackiertem Aluminium.

Materiales: cuerpo de la lámpara en aluminio fundido a presión y pintado.

Specification: the suspension cables are also feed cables.

Spécificité : les câbles de suspension servent également de câbles d'alimentation.

Spezifikation: Die Aufhängung der Leuchte dient gleichzeitig als Netzkabel zur Stromversorgung.

Especificaciones: los cables de suspensión funcionan también de alimentación.

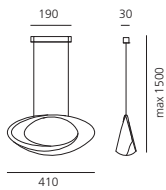

HALO max 1x230W (R7s)
Lamp included
Dimmable



Energy Label n°5



Tolomeo sospensione
due bracci alluminio

design

Michele De Lucchi
Giancarlo Fassina
1996

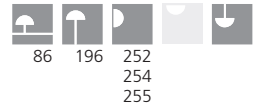

Light emission



Colours



Materiali: struttura a bracci mobili in alluminio lucidato; diffusore in alluminio anodizzato opaco; snodi in alluminio brillantato.
Specificità: tige rigida adattabile in funzione dell'altezza del soffitto. Sistema di equilibratura a molle.

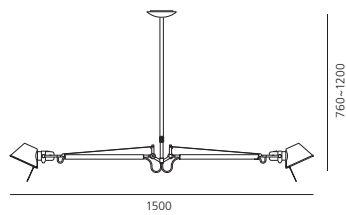

HALO max 2x77W (E27)
Dimmable



Energy Label n°6

Materials: cantilevered arms in polished aluminium; diffuser in matt anodised aluminium; joints in polished aluminium.

Specification: rigid rod adjustable for different ceiling heights. System of spring balancing.

Matériaux : structure à bras articulés en aluminium poli ; diffuseur en aluminium anodisé opaque, rotules en aluminium brillant.

Spécificité : tige rigide, adaptable aux différentes hauteurs de plafond. Système d'équilibrage à ressorts.

Materialien: Ausrichtbare Arme aus glänzendem Aluminium; Kopf aus matt eloxiertem Aluminium; Gelenke aus poliertem Aluminium.

Spezifikation: Höhenverstellbarer Stab. Mit Federausgleichsystem.

Materiales: estructura con brazos móviles de aluminio pulido; difusor en aluminio anodizado opaco; articulaciones de aluminio pulido.

Especificaciones: la varilla rígida se regula con arreglo a la altura del techo. Sistema de equilibrado a muelles.



Tolomeo sospensione
due bracci pergamena

design

Michele De Lucchi
Giancarlo Fassina
2005



Light emission



Colours

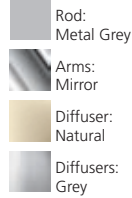

Materiali: struttura a bracci mobili in alluminio lucidato; diffusori in carta pergamena o in raso di seta supportato da materiale plastico; snodi in alluminio brillantato.

Specificità: i diffusori nel normale utilizzo si dispongono verticalmente, indipendentemente dall'angolazione del braccio. Tige rigida adattabile in funzione dell'altezza del soffitto. Sistema di equilibratura a molle.

Materials: cantilevered arms in polished aluminium; diffuser in parchment paper or in silk satin fabric on a plastic frame, joints in polished aluminium.

Matériaux : structure à bras articulés en aluminium poli ; diffuseur en papier parchemin ou en polycarbonate recouvert de satin de soie gris; articulations en aluminium brillant.

Materialien: Ausrichtbare Arme aus glänzendem Aluminium; Schirm aus mit Kunststoff stabilisiertem Pergamentpapier oder Seidensatin; Gelenke aus poliertem Aluminium.

Materiales: estructura con brazos móviles de aluminio pulido; difusor en pergamino o en raso seda reforzado con plástico; articulaciones de aluminio pulido.

Specification: the diffusers, available in four sizes, normally used, remains vertical regardless of the angle of the arm. Rigid rod adjustable for different ceiling heights. System of spring balancing.

Spécificité : les diffuseurs, disponibles en quatre tailles, dans le cadre d'une utilisation normale, les diffuseurs se placent verticalement, indépendamment de la position du bras. Tige rigide, adaptable aux différentes hauteurs de plafond. Système d'équilibrage à ressorts.

Spezifikationen: Bei normaler Anwendung befinden sich die Schirme (erhältlich in vier Größen) in einer vertikalen Position, unabhängig von der Ausrichtung des Armes. Höhenverstellbarer Stab. Federausgleichsystem.

Especificaciones: los difusores, disponibles en cuatro tamaños, en su uso normal, se disponen verticalmente, independientemente de la angulación del brazo. La varilla rígida se regula con arreglo a la altura del techo. Sistema de equilibrado a muelles.

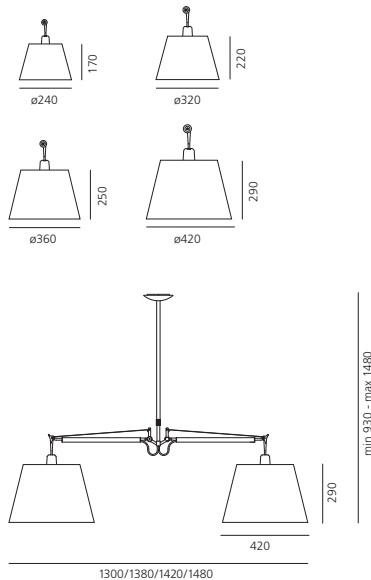

HALO max 2x150W (E27)
Dimmable
or FLUO max 1x23W (E27)



Energy Label n°6



Tolomeo sospensione
decentrata

design

Michele De Lucchi
Giancarlo Fassina
1996

86	196	252		
98	198	254		
		255		
		259		

Light emission



Colours



Structure:
Mirror

Diffuser:
Metal Grey

Diffuser:
Natural

Diffuser:
Grey

Materiali: struttura a bracci mobili in alluminio lucidato; snodi in alluminio brillantato; diffusori in alluminio opaco o carta pergamena o seta di raso.
Specificità: disponibile con diffusori di diverse forme, dimensioni e materiali. Sistema di equilibratura a molle.

Awards

2001 – iF Product Design Award
Hannover (Deutschland)

2001 – Focus Mobilität Internationaler
Designpreis – Baden Württemberg
Stuttgart (Deutschland)

Materials: cantilevered arms
in polished aluminium; joints
in polished aluminium;
diffuser in matt aluminium
or in parchment paper or silk
satin fabric.

Matériaux : structure à bras
articulés en aluminium poli ;
articulations en aluminium
brillant ; diffuseur en alu-
minium opaque en papier
parchemin, ou en satin de
soie gris.

Materialien: Ausrichtbare
Arme aus glänzendem
Aluminium; Gelenke aus
poliertem Aluminium;
Schirm aus mattem
Aluminium, Pergamentpapier,
Seidensatin.

Materiales: estructura con
brazos móviles de aluminio
pulido; articulaciones de
aluminio pulido; difusores
de aluminio opaco,
en pergamino o en raso
seda.

Specification: available with
different shapes, sizes
and materials diffusers.
System of spring balancing.

Spécificité : disponible
avec diffuseurs de formes,
de tailles et de matériaux
différents. Système d'équili-
brage à ressorts.

Spezifikation: Erhältlich
mit verschiedenen Schirmen
in unterschiedlichen Größen
und aus verschiedenen
Materialien.

Especificaciones: está
disponible con difusores
de formas, tamaños
y materiales diferentes.
Sistema de equilibrado
a muelles.

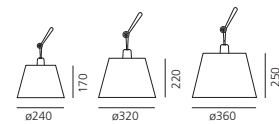
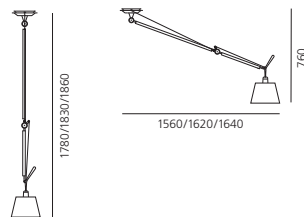
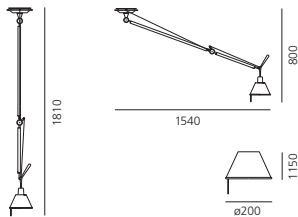

Aluminium diffuser

HALO max 1x77W (E27)
Dimmable



Energy Label n°6

Parchment paper/silk satin fabric diffuser

Diffuser ø 24 cm
HALO max 1x77W (E 27)
Dimmable
or FLUO max 1x16W (E27)
or LED max 1x14,5W (E27)

Energy Label n°6

Diffuser ø 32, 36 cm
HALO max 1x150W (E27)
Dimmable
or FLUO max 1x23W (E27)
or LED max 1x14,5W (E27)



Energy Label n°6



Silk satin fabric diffuser

Aluminium diffuser

Parchment paper diffuser



Light emission



Colours



Materiali: struttura in alluminio e metacrilato trasparente stampato ad iniezione; diffusore in carta pergamena, in raso di seta o in tessuto nero supportato da materiale plastico.

Materials: aluminium and transparent injection-moulded methacrylate structure; diffuser in parchment paper, in silk satin or in black fabric on a plastic frame.

Matériaux : structure en aluminium et en méthacrylate transparent ; diffuseur en papier parchemin, en polycarbonate ou en tissu noir recouvert de satin de soie gris ou noir.

Materialien: Struktur aus Aluminium und transparentem Metacrylat-Spritzguss; Schirm aus mit Kunststoff stabilisiertem Pergamentpapier, Seidensatin oder Gewebe schwarz Gelenke.

Materiales: estructura en aluminio y metacrilato transparente moldeado por inyección; difusor en pergamino, en raso seda o en tejido negro reforzado con plástico.

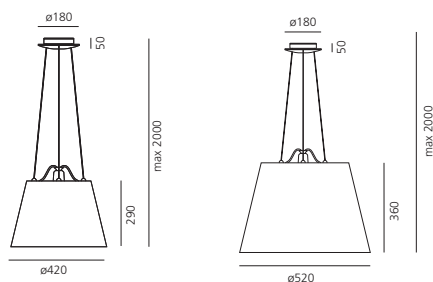

diffuser 420

diffuser 520

HALO max 1x105W (E 27)
Dimmable
or FLUO max1x23W (E27)
or LED max1x17W (E27)



Energy Label n°6



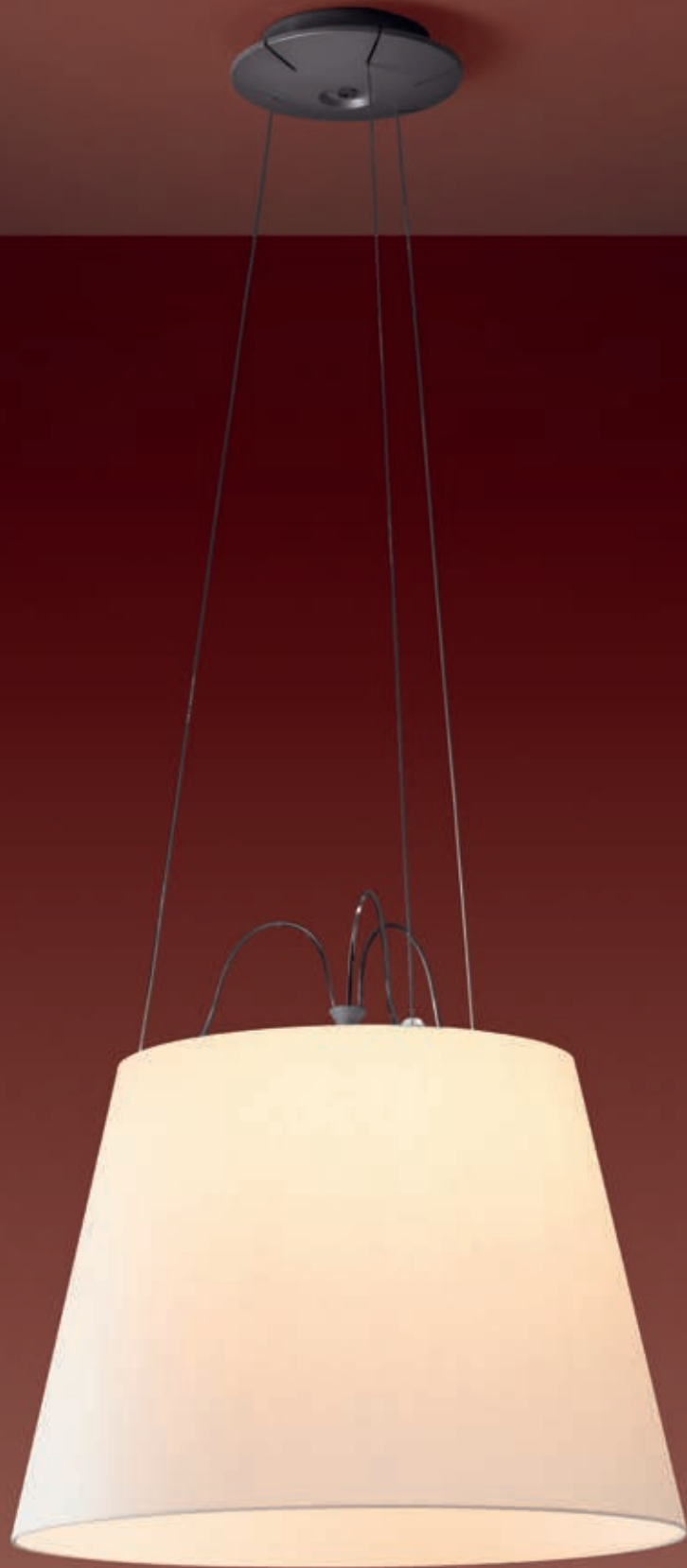

Choose sospensione
Choose mega sospensione

design
Matteo Thun
2008



Light emission



Colours



Transparent + Red



Transparent + Natural

Materiali: diffusore in materiale termoformato accoppiato a un foglio di polipropilene serigrafato rosso o da carta pergamenata.

Materials: diffuser in thermoformed material joined with red silkscreened polypropylene sheet or parchment paper.

Matériaux : diffuseur en matériau thermoformé couplé à une feuille de polypropylène sérigraphié rouge ou avec papier parchemin.

Materialien: Verstellbarer Schirm aus thermogeformtem Polypropylen entweder rot oder mit Pergamentpapier.

Materiales: difusor orientable de material termoconformado junto con tejido de polipropileno rojo serigrafado o con tela de pergamino.

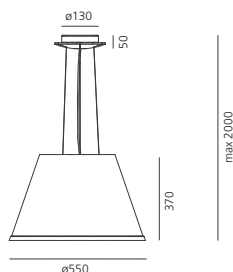
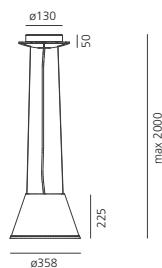

Choose mega sospensione Fluo

FLUO 3x18W (GX 24 q-2) – TC-TEL
With electronic ballast
Not dimmable



Energy Label n°7

Choose mega sospensione

HALO max 3x77W (E27)
Dimmable
or LED max 3x14,5W (E27)



Energy Label n°6

Choose sospensione

HALO max 1x77W (E27)
Dimmable



Energy Label n°6



Choose

Choose Mega



Light emission



Colour



Materiali: corpo illuminante in alluminio verniciato; diffusore in metacrilato opalino stampato a iniezione.

Materials: painted aluminium lighting unit; injection-moulded opal methacrylate diffuser.

Matériaux : corps en aluminium peint ; diffuseurs en méthacrylate opalin moulé par injection.

Materialien: Leuchtkörper aus lackiertem Aluminium; Diffusor aus opalem Spritzguss-Methacrylat.

Materiales: cuerpo de iluminación de aluminio pintado; difusor de metacrilato opalino, moldeado por inyección.

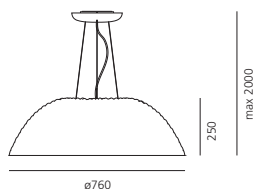
**Cosmic Rotation sospensione Fluo**

FLUO 2x42W (Gx24q-4) – TC-TEL

Lamp included

With electronic ballast

Not dimmable



Energy Label n°35

Cosmic Rotation sospensione Halo

HALO max 2x120W (R7s)

Lamp included

Dimmable



Energy Label n°29



Cosmic Landscape
sospensione

design

Ross Lovegrove
2010



Light emission



Colour



White

Materiali: struttura in metacrilato trasparente; diffusore in metacrilato opalino stampato a iniezione.

Materials: transparent methacrylate structure; injection-moulded opal methacrylate diffuser.

Matériaux : structure en méthacrylate transparent ; diffuseurs en méthacrylate opalin moulé par injection.

Materialien: Struktur aus transparentem Methacrylat. Diffusor aus opalem Spritzguss-Methacrylat.

Materiales: estructura de metacrilato transparente; difusor de metacrilato opalino, moldeado por inyección.

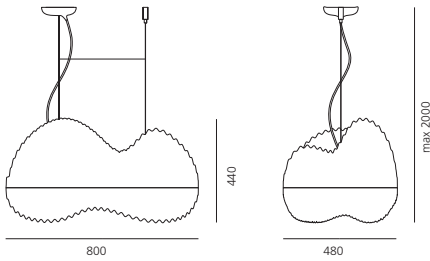

FLUO 2x55W (2G11) – TC-LEL
Lamp included
Dimmable



Energy Label n°33



Empirico sospensione Empirico system

design

Karim Rashid
2011



Light emission



Colour



White

Materiali: polietilene neutro stampato in tecnica rotazionale con finitura superficiale lucida.

Specificità: l'elemento singolo può essere aggregato a formare un sistema composto da più moduli, per ottenere diverse configurazioni.

Materials: rotationally moulded polyethylene, transparent finish.

Matériaux : polyéthylène neutre roto-moulé, finition transparent.

Materialien: Polyethylen, hergestellt im Rotations-spritzgussverfahren, transparentes Finish.

Materiales: polietileno neutral trabajado mediante moldeo rotacional con acabado transparente.

Specification: single elements could be joined to create a system with different possible configurations.

Spécificité : des éléments simples peuvent être assemblés de façon à créer un système de différentes configurations possibles.

Spezifikation: Die Einzelemente lassen sich zu einem System zusammenfügen, so dass individuelle Konfigurationen geschaffen werden können.

Especificaciones: el elemento individual puede ser añadido para formar un sistema compuesto por más módulos, para obtener diversas configuraciones.

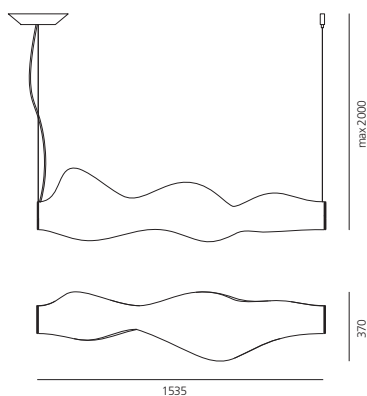

Empirico sospensione

FLUO max 2x35W (G5) – T16
Lamp included
With electronic ballast
Dimmable



Energy Label n°9

Empirico system

FLUO max 2x35W (G5) – T16 (1 module)
Lamp included
With electronic ballast
Dimmable



Energy Label n°9



DB Hotel, Verona (IT)





Light emission



Colour



White

Materiali: polietilene stampato in tecnica rotazionale.

Materials: rotationally moulded polyethylene.

Matériaux : polyéthylène roto-moulé.

Materialien: Polyethylen hergestellt im Rotations-spritzgussverfahren.

Materiales: polietileno trabajado mediante moldeo rotacional.

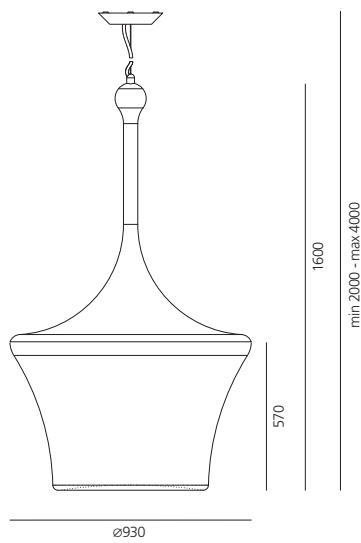

FLUO 4x55W (2G11) TC-LEL
Lamp included
With electronic ballast
Dimmable
+

LED 1,2W blue

IP65

Energy Label n°54





Light emission



Colour



White

Materiali: polietilene stampato in tecnica rotazionale.

Materials: rotationally
moulded polyethylene.

Matériaux : polyéthylène
roto-moulé.

Materialien: polyethylen
hergestellt im
Rotations-spritzgussverfahren.

Materiales: polietileno
trabajado mediante
moldeo rotacional.

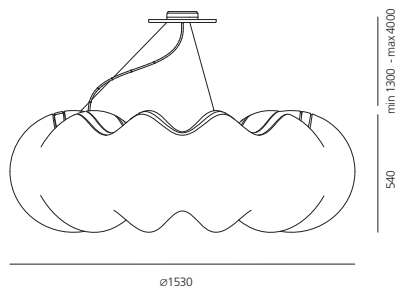

FLUO 6x55W (2G11) TC-LEL
Lamp included
Dimmable



Energy Label n°33



Mouette simmetrica
Mouette asimmetrica
Mouette mini

design

Wilmotte & Associés
2004, 2010



Light emission



Colour



White

Materiali: struttura in estruso di alluminio verniciato; diffusore in polipropilene stampato in tecnica rotazionale; cavetti in acciaio.
Specificità: disponibile nelle versioni simmetrica, asimmetrica e mini, dimmerabile e non dimmerabile.

Awards

2005 – Design Innovationen
Design Zentrum Nordrhein Westfalen
Reddot Design Award 2005
“Reddot: best of the best”
Essen (Deutschland)

Materials: extruded aluminium structure; rotational moulded polypropylene diffuser; steel suspension wires.

Matériaux : structure en aluminium extrudé ; diffuseur en polypropylène moulé ; câbles de suspension en acier.

Materialien: Montageprofil aus fließgepresstem Aluminium; Schirm aus Polypropylen hergestellt im Rotations-Spritzgussverfahren; Stahlseile.

Materiales: estructura en estruso de aluminio; difusor en polipropileno estampado con técnica rotacional; cables de suspensión en acero.

Specification: available in the versions symmetrical, asymmetrical and mini, dimmable and non dimmable.

Spécificité : disponible en version symétrique, asymétrique et mini, dimmable ou non dimmable.

Spezifikation: Erhältlich in den Versionen Asymmetrisch, Symmetrisch und Mini. Dimmbare Ausführung wahlweise erhältlich.

Especificaciones: está disponible en versiones imétrica, asimétrica y mini, dimerable y no dimerable.

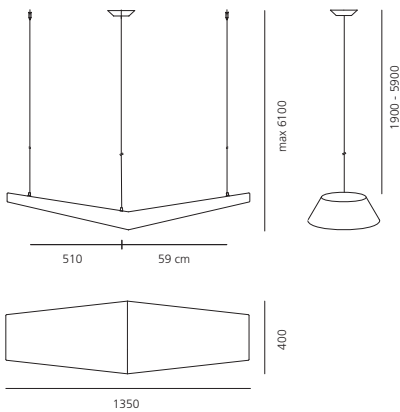

Mouette simmetrica

FLUO 4x24W (G 5) – T 16
Lamp included
Dimmable or not dimmable



Energy Label n°33

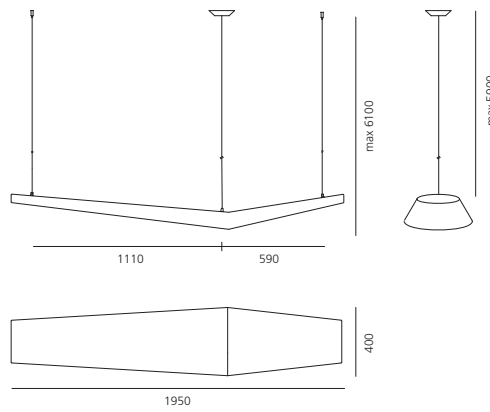

Mouette asimmetrica

FLUO 2x24W (G 5) – T 16
+
FLUO 2x54W (G 5) – T 16
Lamp included
Dimmable or not dimmable



Energy Label n°33

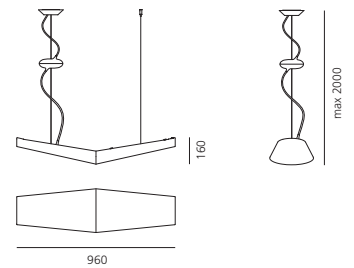

Mouette mini

FLUO 2x36W (2G 11) – TC-LEL
Lamp included
Dimmable



Energy Label n°33

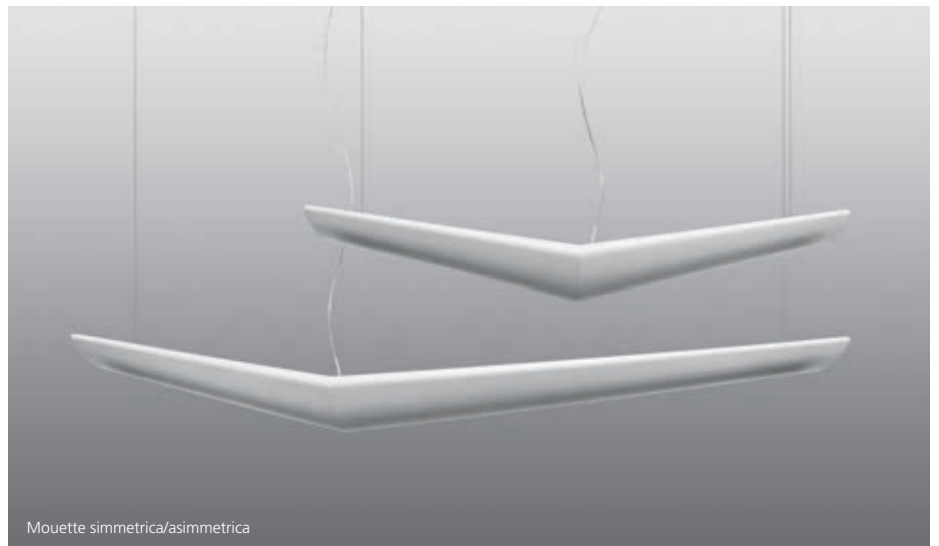

Mouette simmetrica/asimmetrica



Mouette mini





Master's Pieces



418
Alfa



419
Eclisse



420
Lesbo



432
Mezzachimera



434
Prometeo



435
Montjuic



421
Nesso



422
Fato



424
Patrolo



425
Boalum



426
Callimaco

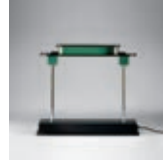

428
Pausania



430
Shogun tavolo



432
Chimera



436
Genesy



438
Pipe terra
parete/soffitto/sosp.



442
Pantolica
sospensione, parete



444
Noto



Light emission



Colours

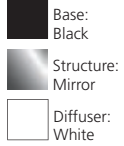

Materiali: struttura in metallo nichelato opaco; diffusore in cristallo; base in marmo. Parti metalliche tornite a mano.

Materials: metal structure in opaque nickel-plate; diffuser in crystal glass; base in marble. The metal parts are hand turned.

Matériaux : structure en métal nickelé mat ; diffuseur en verre ; base en marbre. Les parties métalliques sont tournées à la main.

Materialien: Rahmen aus matt vernickeltem Metall; Leuchtschirm aus Kristall. Sockel aus Marmor. Die Metallteile sind handgedreht.

Materiales: estructura de metal niquelado mate; difusor de cristal; base de mármol. Las piezas metálicas están torneadas a mano.

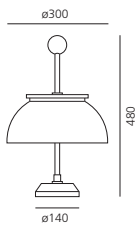

HALO max 2x28W (E14)

IP20  +  Dimmer

Energy Label n°30





Light emission



Colours



Polished White



Polished Orange



Polished Red



Silver Grey

Materiali: metallo verniciato.
Specificità: installabile anche a parete.

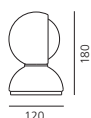
Materials: painted metal.**Matériaux :** métal verni.**Materialien:** Lackiertes Metall.**Materiales:** metal pintado.**Specificity:** can also be wall-mounted.**Spécificité :** fixation possible en applique.**Spezifikation:** Wandmontage möglich.**Especificaciones:** posibilidad de instalación a pared.

HALO max 1x18W (E14)
or FLUO max 1x5W (E14)
or LED max 1x4,5W (E14)



Energy Label n°30

Awards

1967 – Compasso d'Oro/ADI
XIV Triennale di Milano
Milano (Italia)

Museums

Twentieth Century Design Collection
of the Metropolitan Museum of Art
New York (US)

Design Collection of the Museum
of Modern Art – New York (US)

Itinerario Storico Permanente
Museo Nazionale della Scienza
e della Tecnica L. da Vinci
Milano (Italia)

Sezione Design
Civica Galleria d'Arte Moderna
Gallarate (Italia)

The Denver Art Museum
Denver (Colorado, US)

The Israel Museum – Jerusalem (Israel)

Musée des Arts Décoratifs
de Montréal – Montréal (Canada)

Museo Permanente del Design Italiano
1945/1990 – Triennale di Milano
Milano (Italia)

Galleria Nazionale d'Arte Moderna
Roma (Italia)



Lesbo

design

Angelo Mangiarotti
1967



Light emission



Colour



White

Materiali: corpo e diffusore in vetro Murano soffiato-sfumato,
base in metallo lucidato.

Materials: body and diffuser
in blown frosted Murano
glass; base in polished metal.

Matériaux : corps et
diffuseur en verre de Murano
soufflé ; base en métal poli.

Materialien: Körper und
Leuchtschirm aus opal-
weißem, mundgeblasenem
Muranoglas; Sockel aus
poliertem Metall.

Materiales: cuerpo y
difusor de cristal de Murano
ahumado-soplado, base de
metal pulido.

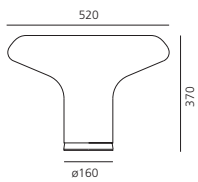

HALO max 1x77W (E27)

IP20    Dimmer

Energy Label n°6





Giancarlo Mattioli
Gruppo architetti urbanisti città nuova
1967

Light emission



Colours



White



Orange

Materiali: base e diffusore in resina ABS stampata ad iniezione in stampi cromati.

Materials: base and diffuser in ABS resin, injected in chromed moulds.

Matériaux : base et diffuseur en résine ABS, injection dans des moules en chrome.

Materialien: Sockel und Leuchtschirm ABS-Kunstharz, das im Spritzgussverfahren in verchromten Gussformen hergestellt wird.

Materiales: base y difusor de resina ABS, moldeados por inyección en moldes cromados.

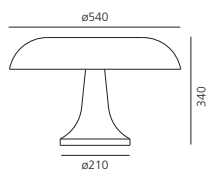

HALO max 4x18W (E14)
or FLUO max 4x5W (E14)
or LED max 4x4,5W (E14)



Energy Label n°30

Awards

1965 – 1° Premio Concorso
Studio Artemide/Domus
Milano (Italia)

Museums

Twentieth Century Design Collection
of the Metropolitan Museum of Art
New York (US)

Design Collection of the Museum
of Modern Art – New York (US)

The Denver Art Museum
Denver (Colorado, US)

The Israel Museum – Jerusalem (Israel)

Musée des Arts Décoratifs de Montréal
Montréal (Canada)

Museo Permanente del Design Italiano
1945-1990 – Triennale di Milano
Milano (Italia)





Light emission



Colour



White



Gold

Materiali: struttura in lamiera piegata, saldata e smaltata bianca.

Specificità: questa lampada, con i suoi schermi metallici geometrici, le sue campiture di luce ed ombra, di vuoti e pieni, racchiusi in una cornice quadrata, si presenta come un oggetto luminoso dalla duplice funzione: lampada e insieme vetrina. Una scultura luminosa con una forte connotazione stilistica tipica degli anni 60.

Materials: structure in white enamelled, folded and welded plate. Indirect emission.

Matériaux : structure en tôle émaillée blanche pliée et soudée.

Materialien: Rahmen aus weißem, gekrümmtem, geschweißtem und lackiertem Metall.

Materiales: estructura de chapa esmaltada doblada y soldada blanca.

Specificity: a table or wall lamp, with geometrical metal screens creating light and dark, screen and void, all enclosed in a square frame: it is both a light and a display piece. A lighting sculpture with a strong '60s design influence.

Spécificité : avec ses écrans métalliques géométriques, ses peintures de fond de lumière et d'ombre, de pleins et de vides, renfermés dans un cadre carré, cette lampe de table ou applique se présente tel un objet lumineux multifonctions : lampe et vitrine évoquant une sculpture lumineuse dans les style typique des années 60.

Spezifikation: Die geometrischen Flächen in dem quadratischen Metallrahmen erzeugen ein attraktives Licht- und Schattenspiel. Fato ist Leuchte und Objekt zugleich. Ob Vitrine oder Tisch- oder Wandleuchte, Fato ist eine Lichtskulptur im typischen Stil der 60er Jahre. Eine Lichtskulptur mit einer starken stilistischen, Konnotation der 60er Jahre.

Especificaciones: esta lámpara de sobremesa o de pared con sus pantallas metálicas geométricas, sus juegos de luz y sombras, vacío y llenos, encerrado en un marco cuadrado, se presenta como un objeto luminoso multiuso: lámpara y vitrina. Una escultura luminosa con una fuerte connotación estilística típica de los años 60.

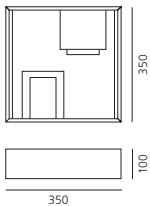

HALO max 2x28W (E14)
or FLUO max 2x8W (E14)
or LED max 2x4,5W (E14)



Energy Label n°30



Ph. Aldo Ballo, 1969





Light emission



Colour



White

Museums

Twentieth Century Design Collection
of the Metropolitan Museum of Art
New York (US)

The Denver Art Museum
Denver (Colorado, US)

Materiali: corpo in vetro soffiato trasparente con parte del diffusore rivestita da un'armatura metallica romboidale irregolare. L'armatura è ottenuta con la saldatura di fili d'acciaio resistenti al calore del vetro che viene soffiato a mano nella gabbia.

Specificità: il vetro così sfaccettato produce una texture luminosa sulle pareti.

Materials: body in transparent blown glass with the diffuser partially covered by an irregular rhomboid metal frame. The frame is made by welding steel wire, resistant to the heat of the glass which is hand-blown inside the cage.

Matériaux : corps en verre soufflé transparent avec un diffuseur revêtu d'une armature métallique rhomboïdale irrégulière. L'armature est réalisée grâce au soudage de fils d'acier résistant à la chaleur du verre qui est soufflé dans la cage.

Materialien: Gehäuse aus transparentem, geblasenem Glas, das mit einem unregelmäßigen, rhomboiden Metallnetz verkleidet ist.

Materiales: cuerpo de cristal soplado transparente con la parte de difusor forrada de un armazón metálico en forma de rombo irregular. El armazón se consigue soldando hilos de acero resistentes al calor del cristal, que se sopla en la caja.

Specificity: the faceted glass creates light patterns on the wall.

Spécificité : ainsi taillé en facettes, le verre éclaire la pièce avec des effets tachetés.

Spezifikation: Das Glas wird durch das Netz mundgeblasen und verschmilzt.

Especificaciones: el cristal tallado de esta manera ilumina la habitación con signos diferentes.

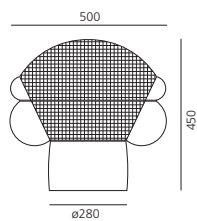

HALO max 1x77W (E27)

IP20 + Dimmer

Energy Label n°6



Boalum

design

Livio Castiglioni
Gianfranco Frattini
1970



Light emission



Colour



White

Materiali: struttura in plastica bianca flessibile rinforzata e terminali in resina.
Specificità: le piccole lampadine a siluro sono collegate in serie l'una all'altra e distanziate da una sfera isolante.
I diversi elementi sono collegabili in serie fino ad un massimo di 4 pezzi per uno sviluppo di 8 metri circa e arrotolabili a piacere.

Awards

1975 – BIO 5 – Honour Nomination
Ljubljana (Slovenia)

Museums

Musée des Arts Décoratifs de Montréal
Montréal (Canada)

1945-1990 – Museo Permanente
del Design Italiano
Triennale di Milano Milano (Italia)

Materials: structure in reinforced flexible white plastic with ends in resin.

Specificity: the small torpedo lamps are connected to each other in series and separated by an insulating sphere. Up to 4 individual sections may be connected to each other in series to make a length of 8 metres which may be wound into any shape.

Matériaux : structure en plastique blanc flexible renforcée et extrémités en résine.

Spécificité : les petites ampoules à siluro sont raccordées en série les unes aux autres et séparées par une boule isolante. Les différents éléments flexibles sur toute leur longueur peuvent se raccorder pour composer un ensemble de 4 pièces d'environ 8 mètres. Emission lumineuse diffuse.

Materialien: Rahmen aus weißem, flexiblem Kunststoff und Endstücke aus Kunstharz.

Spezifikation: Die hinter einander liegenden kleinen Torpedolampen sind mit einander verbunden, zwischen ihnen liegt je eine isolierende Kugel. Maximal 4 Leuchten mit einer Gesamtlänge von 8m lassen sich zusammenstecken. Boalum kann beliebig zusammengerollt werden. Diffuse Lichtverteilung.

Materiales: estructura de plástico blanco flexible reforzado y terminales de resina.

Especificaciones: las pequeñas bombillas en forma de siluro están unidas en serie la una con la otra y distanciadas por una esfera aislante. Los elementos se pueden unir en serie hasta un máximo de 4 piezas, con un desarrollo de unos 8 metros, pudiéndolos enrollar a su gusto.

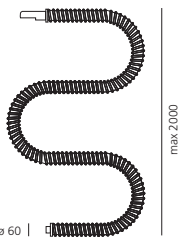

INC max 25x5W/12V
Lamp included
Electric power transformer included



Energy Label n°18



Ph. Aldo Ballo, 1970

Callimaco

design

Ettore Sottsass

1982



Light emission



Colours



Base:
Polished grey



Stem:
Polished yellow



Diffuser:
Polished red

Materiali: base e diffusore in acciaio verniciato; stelo in alluminio verniciato; maniglia in metallo cromato lucido.

Materials: base and diffuser in painted steel; stem in painted aluminium; handle in polished chrome metal plate.

Matériaux : base et diffuseur en acier verni ; tige en aluminium verni ; poignée en métal chromé.

Materialien: Sockel und Schirm aus lackiertem Stahl; Säule aus lackiertem Aluminium; Griff aus poliertem, verchromtem Metall.

Materiales: pie y difusor de acero pintado; vástago de aluminio pintado y empuñadura, de metal cromado lúcido.

Awards

Twentieth Century Design Collection of the Metropolitan Museum of Art New York (US)

The Israel Museum Jerusalem (Israel)

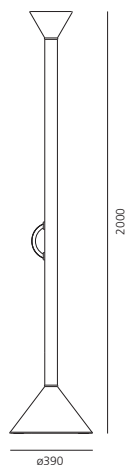

Callimaco

HALO max 1x230W (R7s)
Color temperature 2950K
Lighting output 5000lm

IP20 Touch Dimmer

Energy Label n°5

Callimaco LED

LED Total power 45W
Color temperature 3000K
Lighting output 3450lm

IP20 Touch Dimmer

Energy Label n°1



LED version touch dimmer



Pausania

design

TW Tunable white



Ettore Sottsass
1983

Light emission



Colour



Green / Aluminium

Riedizione della celebre lampada ministeriale di Ettore Sottsass, aggiornata in versione LED TW a luce bianca variabile.

Materiali: corpo in resina nera, diffusore in metacrilato verde.

Re-edition of the famous lamp designed by Ettore Sottsass, updated in version LED TW at variable white light.

Il s'agit d'une réédition de la célèbre lampe ministérielle d'Ettore Sottsass, adaptée en version LED TW et dotée d'un variateur afin de piloter la température de couleur de la lumière.

Neuaufgabe der bekannten Leuchte von Ettore Sottsass als LED TW-Version, die Weißlicht in verschiedenen Lichtstärken und Farbtemperaturen abgibt.

Reedición de la célebre lámpara de Ettore Sottsass, actualizada en versión LED TW con luz blanca variable.

Materials: body in black resin, diffuser in green synthetic material.

Matériaux : corps en résine noire, diffuseur en méthacrylate vert.

Materialien: Körper aus schwarzem Kunstharz, Schirm aus grünem Methacrylat.

Materiales: cuerpo en resina negra, difusor en metacrilato verde.

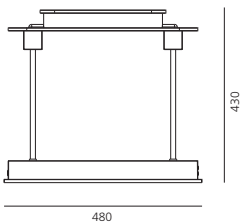

LED total power 10W
Warm-Cold white 2700-6500K
Lighting output 900lm

IP20  +  Dimmer

Energy Label n°1



Ph. Aldo Ballo, 1983

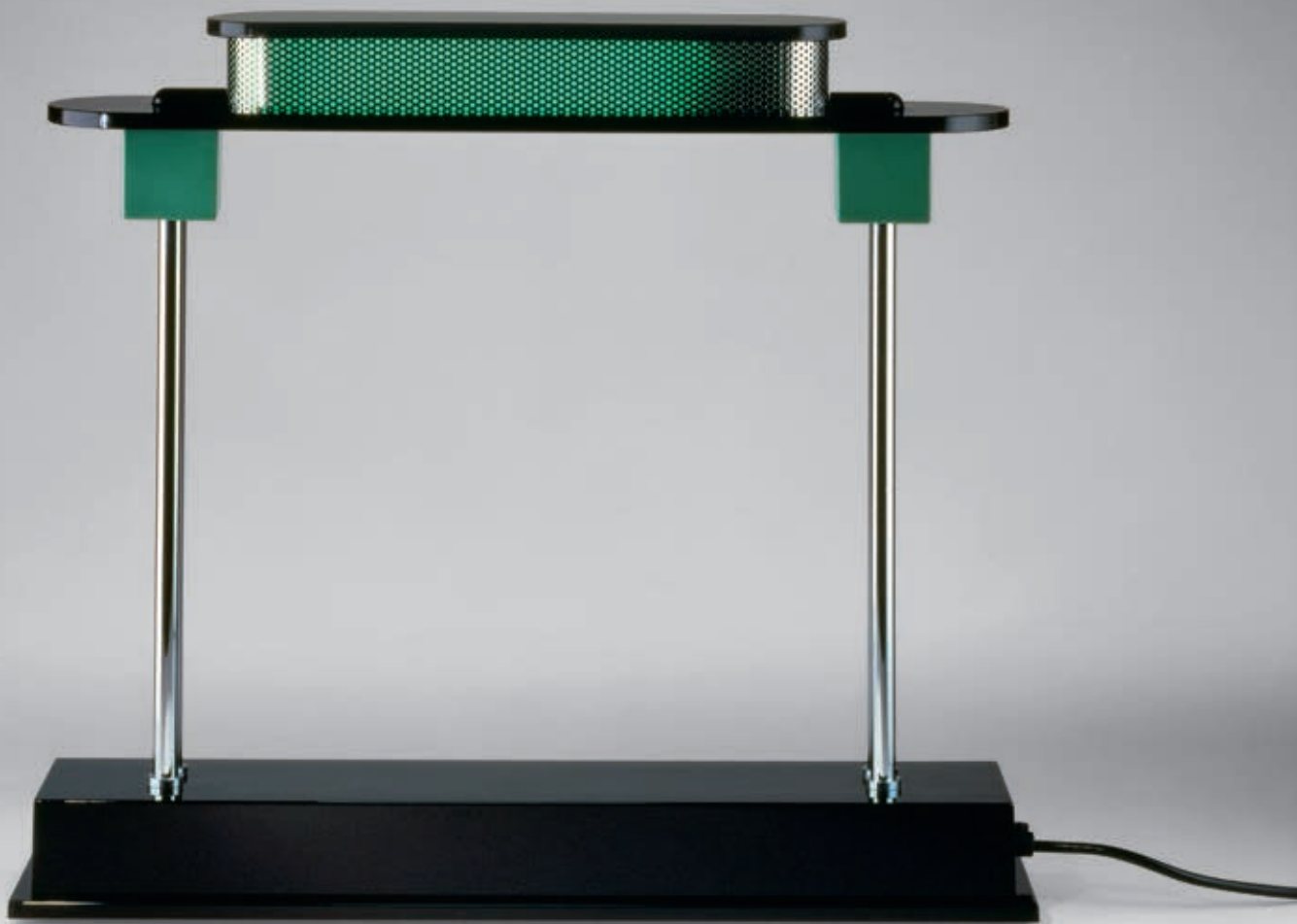

Shogun tavolo

design

Mario Botta

1986



Light emission



Colour



Black / White

Awards

Twentieth Century Design Collection of the Metropolitan Museum of Art New York (USA)

Materials: painted metal stem; white adjustable diffusers in painted perforated plate steel.

Matériaux : structure en métal verni ; diffuseurs orientables en tôle d'acier perforé verni.

Materialien: Säule aus lackiertem Metall, verstellbare Schirme aus gelochtem Stahlblech.

Materiales: vástago de metal pintado; difusores pintados orientables, de chapa de acero perforada.

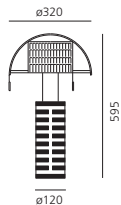

HALO max 1x150W (E27)

IP20 EAC

Energy Label n°6



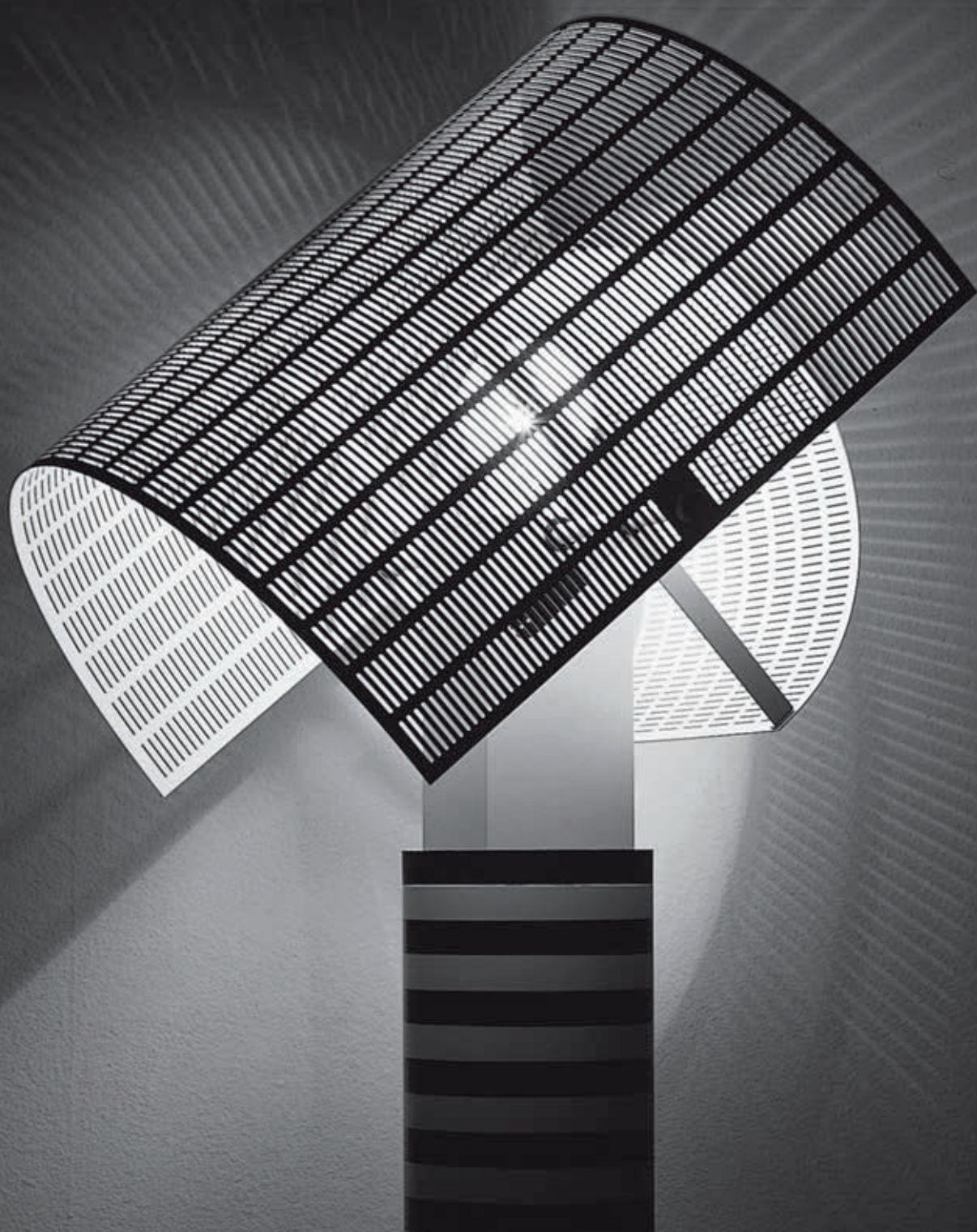

Chimera
Mezzachimera

design

Vico Magistretti
1969, 1970



Light emission



Colour



White

Materiali: base in metallo verniciato; struttura/diffusore in metacrilato opalino curvato a caldo.

Materials: base in painted metal; structure/diffuser in heat-curved opal methacrylate.

Matériaux : base en métal verni ; structure/diffuseur en méthacrylate opalin courbés à chaud.

Materialien: Sockel aus lackiertem Metall; Rahmen/Leuchtschirm aus opalem Methacrylat, heiß gebogen.

Materiales: base de metal pintado; estructura/difusor de metacrilato opalino curvado en caliente.

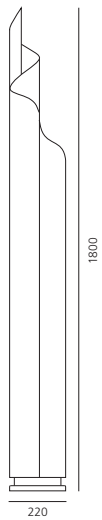

Chimera

FLUO 3x28W (G5) – T16
Lamp included
With electronic ballast



+ [Dimmer icon] - Dimmer

Energy Label n°23

Mezzachimera

HALO 3x60W (E27)
or FLUO max 3x20W (E27)
or LED max 3x17W (E27)



Energy Label n°6





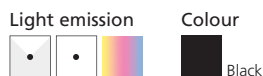

Materiali: acciaio verniciato; schermi diffusori in metacrilato opalino.
Specificità: tre proiettori con i filtri dicroici rosso, verde e blu consentono di ottenere infinite atmosfere di luce colorata e un quarto proiettore produce luce bianca. Attraverso un telecomando è possibile selezionare 12 atmosfere standard, crearne e memorizzarne ulteriori 86 e agire sull'intensità luminosa.

Materials: matt laquered steel; diffuser screens in opaline methacrylate.

Matériaux : acier verni mat ; écrans diffuseurs en métacrylate opalin.

Materialien : Mattlackierter Stahl; Lichtfenster aus opalem Methacrylat.

Materiales: acero pintado opaco; pantallas difusor en de metacrilato opalino.

Specification: three projectors with red, green and blue dichroic filters allow the creation of a wide range of coloured light atmospheres while a fourth projector emits white light. Using a remote control the user can select 12 standard atmospheres, create and save other 86 and adjust the light intensity.

Spécificité : trois projecteurs avec filtres dichroïques rouge, vert et bleu permettent d'obtenir de nombreuses atmosphères colorées ; un quatrième projecteur produit la lumière blanche. A l'aide de la télécommande, il est possible de sélectionner 12 atmosphères standard, d'en créer et d'en mémoriser 86 autres et d'agir sur l'intensité lumineuse.

Spezifikation: Drei Strahler mit dichroitischem Filter in den Grundfarben Rot, Blau und Grün, erschaffen unzählige farbige Lichtstimmungen. Über ein viertes Element wird Weißlicht erzeugt. Diese Lichtstimmungen sind über eine Fernbedienung abrufbar (12 Standardlichtstimmungen, 86 Einstellungen bzgl. der Lichtintensität).

Especificaciones: tres proyectores con filtros dicroicos, rojo, verde y azul permiten obtener infinitas atmósferas de luz coloradas y el cuarto proyector produce luz blanca. Mediante un mando a distancia es posible manejar 12 atmósferas estándar, crear y memorizar otras 86 y actuar en la intensidad luminosa.

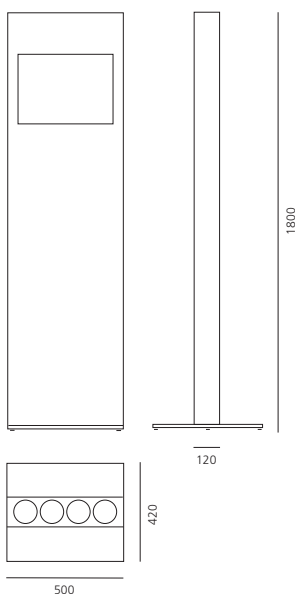

Indirect emission:
HALO max 4x100W (B15d)
Dimmable

Diffused emission:
FLUO 1x36W (2G11) – TC-LEL



Energy Label n°37



Infrared remote control (included)

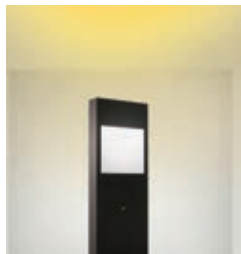
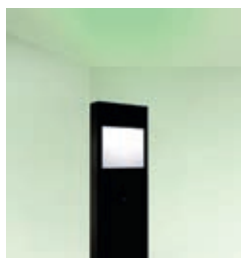

Montjuic

design

Santiago Calatrava
1990



Light emission



Colours



Structure:
Black



Diffuser:
White

Materiali: struttura in resina poliuretana espansa verniciata; diffusore in metacrilato opalino bianco.

Materials: structure in painted foamed polyurethane; white opaline methacrylate diffuser.

Matériaux : structure en résine polyuréthane expansé vernie ; diffuseur en méthacrylate opalin blanc.

Materialien: Struktur aus lackiertem Polyurethanharz; Schirm aus opal weißem Methacrylat.

Materiales: estructura de resina de poliuretano rígido; difusor en metacrilato opalino blanco.

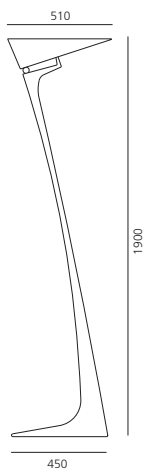

HALO max 1x400W (R7s)
Lamp included

IP20   Dimmer

Energy Label n°5



Ph. Aldo Ballo - 1990

Genesy

design

Zaha Hadid
2009

Light emission



Colours



Polished black



Polished white

Materiali: corpo lampada monomaterico in poliuterano espanso stampato a iniezione.

Specificità: la luce diretta LED e l'indiretta alogena sono gestibili separatamente da due pulsanti touch posti sul corpo lampada.

Materials: injection-moulded foam polyurethane.

Matériaux : mousse de polyuréthane moulée par injection.

Materialien: Poliertes Polyurethan.

Materiales: cuerpo en poliuretano expandido estampado a inyección.

Specification: direct LED light and indirect halogen light can be operated separately by two touch dimmers placed on the body lamp.

Spécificité: la lumière directe à LED et la lumière indirecte halogène sont gérables séparément grâce à deux variateurs sensitifs placés sur le corps de l'appareil.

Spezifikation: Regelung der Beleuchtung (direkt LED, indirekt Halogen) durch zwei getrennte Touch Dimmer am Leuchtenkörper.

Especificaciones: la luz directa LED y la indirecta halógena se gestionan separadamente desde dos pulsantes touch localizados en el cuerpo de la lámpara.

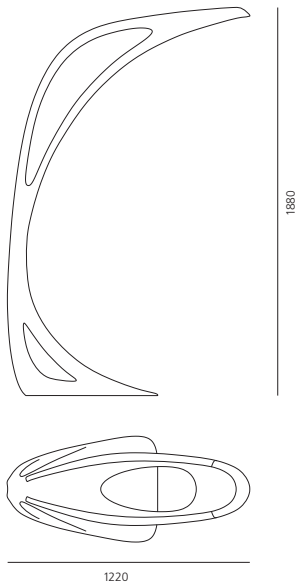

Genesy Halo

Indirect emission:
HALO max 1x230W (R7s)

Direct emission:
LED Total Power 12W
Color temperature 3000K
Lighting output 450lm

IP20 + Touch Dimmer

Energy Label n°16







Materiali: base in acciaio verniciato effetto “soft touch”; stelo rivestito da una guaina di silicone platinico naturale (anti ingiallimento); diffusore in policarbonato trasparente verniciato effetto gomma; lente trasparente; riflettore interno in alluminio speculare con microforature irregolari.
Specificità: costituita da un unico tubo d'acciaio, formato da una parte rigida inferiore e da una flessibile superiore. Dimmer posto lungo lo stelo.



Dimmer

Pipe terra

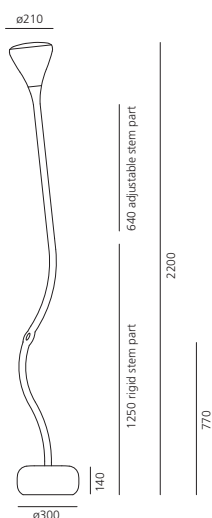

Pipe terra Fluo

FLUO 1x42W (GX24q-4) – TC-TEL
Lamp included
With electronic ballast



+ Dimmer

Energy Label n°35

Light emission



Colours

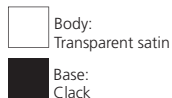

Pipe parete/soffitto

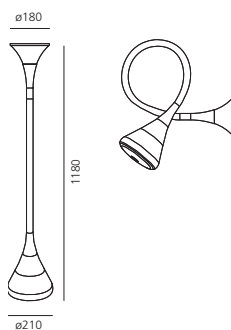

Pipe parete/soffitto Fluo

FLUO 1x32W (GX24q-3) – TC-TEL
Lamp included
With electronic ballast
Not dimmable



Energy Label n°35

Light emission



Colour



Pipe sospensione



Pipe sospensione Fluo

FLUO 1x32W (GX24q-3) – TC-TEL
Lamp included
With electronic ballast
Not dimmable



Energy Label n°35

Light emission



Colour





Pipe terra

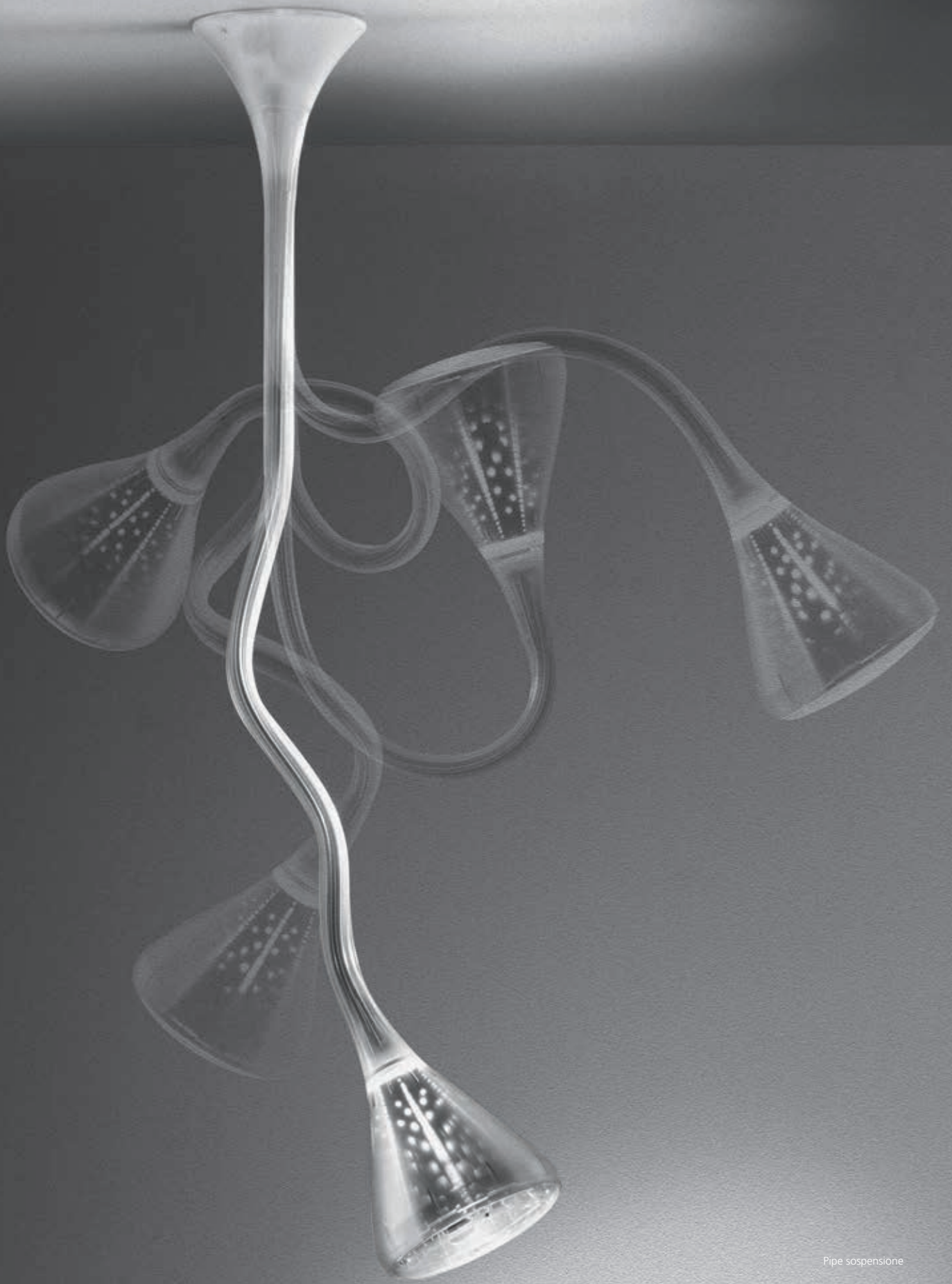

Pipe sospensione

Awards

Pipe

2006 – Reddot Award Product Design
“Best of the best”
Essen (Deutschland)

2008 – Designpreis der Bundesrepublik
Deutschland
Frankfurt (Deutschland)

Pipe sospensione

2004 – Compasso d’Oro / A.D.I.
Milano (Italia)

Intel Design 2003
Categoria Design “Augusto Morello”
Selezione alla III edizione 2003
Milano (Italia)

2004 – Design Plus, light + building
Frankfurt am Main
Deutschland)

Museums

Design Collection of the Museum
of Modern Art – New York (USA)

Materials: painted steel base with “soft touch” effect; stem covered by a natural platinum silicone sheath (antiyellowing); diffuser in transparent polycarbonate with rubber effect coating; transparent lens; internal reflector made of specular aluminium with random perforations.

Specification: the body lamp is a single tubular steel structure, composed of a rigid lower part and an flexible upper part. Touch dimmer on the stem.

Matériaux : base en acier verni peint effet ‘soft touch’; tige revêtue d’une gaine en silicone naturelle transparente (anti jaunissement) ; diffuseur en polycarbonate verni transparent ; réflecteur interne en aluminium spéculaire comprenant de petites perforations.

Spécificité : constitué d’un tube en acier rigide dans sa partie inférieure et flexible dans sa partie supérieure. Variateur sensitif placé sur la tige.

Materialien: Sockel aus lackiertem Stahl mit Soft Touch-Effekt; Stab mit transparentem, platinierterem und gegen Vergilben geschütztem Silikon überzogen; Leuchtenkopf aus gummiartig anmutendem, transparentem Polycarbonat; transparente Linse; Innenreflektor aus verspiegeltem Aluminium.

Spezifikation: Der röhrenförmige Leuchtenkörper besitzt eine Struktur aus Stahl, deren unterer Teil unbeweglich während der obere flexibel und ausrichtbar ist. Lichtaustritt durch unterschiedliche Positionen zu verändern.

Materiales: base en acero pintado efecto “soft touch”; tija revestida por una funda de silicona natural (antioxidante); difusor en policarbonato transparente pintado efecto goma; lente transparente; reflector interno en aluminio “Speculare” con micro agujeros irregulares.

Especificaciones: está constituida por un único tubo de acero, formado por una pared rígida inferior y de una flexible superior. Encendido mediante la modalidad touch para la regulación de la intensidad luminosa colocado a lo largo del asta.



Pipe parete



Pipe soffitto

Pantaliana sospensione
 Pantaliana parete 2
 Pantaliana parete 3

design
 Örne Halloween
 1995, 1996



Light emission



Colours

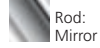

Rod:
Mirror

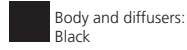

Body and diffusers:
Black

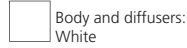

Body and diffusers:
White

Materiali: bracci e coppette in vetro soffiato; tige in acciaio cromato lucido.
Specificità: nella versione sospensione, tige regolabile in altezza.

Materials: arms and bowls in blown glass; polished chrome-plated steel rod.

Matériaux : bras et coupelles en verre soufflé ; tige en acier chromé.

Materialien: Arme und Schalen aus transparentem mundgeblasenen Glas; Pendelstab aus poliertem Chromstahl.

Materiales: metal y cristal soplado; brazos y copas de cristal soplado; tija de acero cromado.

Specificity: pantaliana sospensione: rigid rod adjustable for different ceiling heights.

Spécificité : pantaliana suspension : tige rigide, adaptable aux différentes hauteurs de plafond.

Spezifikation: Pantaliana sospensione: Höhenverstellbarer Stab.

Especificaciones: la versión de suspensión tiene una tija regulable en altura.

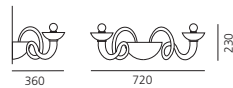
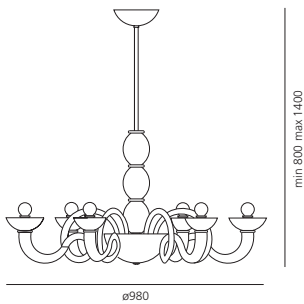

Pantaliana sospensione
 HALO max 6x46W (E 14)
 Dimmable



Energy Label n°30

Pantaliana parete 2
 HALO max 2x46W (E14)
 Dimmable



Energy Label n°30

Pantaliana parete 3
 HALO max 3x46W (E14)
 Dimmable



Energy Label n°30



Pantaliana parete 2



Pantaliana parete 3





Pantlica sospensione



Light emission



Colour



White

Materiali: struttura in acciaio; diffusore in vetro soffiato opalino.
Specificità: è possibile applicare un filtro rosso all'elemento più piccolo del diffusore.

Materials: steel structure; opal blown glass diffuser.

Matériaux : structure en acier; diffuseur en verre soufflé opalin.

Materialien: Struktur aus Stahl, Lichtverteiler aus mundgeblasenem Opalglas.

Materiales: estructura en acero; difusor en cristal soplado opalino.

Specification: a red filter can be applied to the smallest diffuser module.

Spécificité : possibilité d'appliquer un filtre rouge sur le plus petit diffuseur.

Spezifikation: Wahlweise Anbringung eines roten Filters am kleinsten Schirmelement möglich.

Especificaciones: posibilidad de aplicar un filtro rojo al elemento más pequeño del difusor.

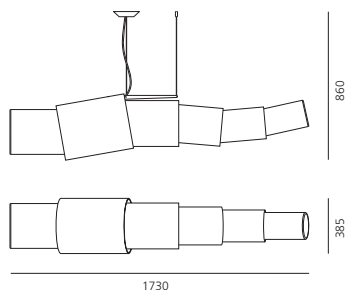

FLUO 2x80W (G5) - T16
Lamp included
With electronic ballast
Dimmable or not dimmable



Energy Label n°33

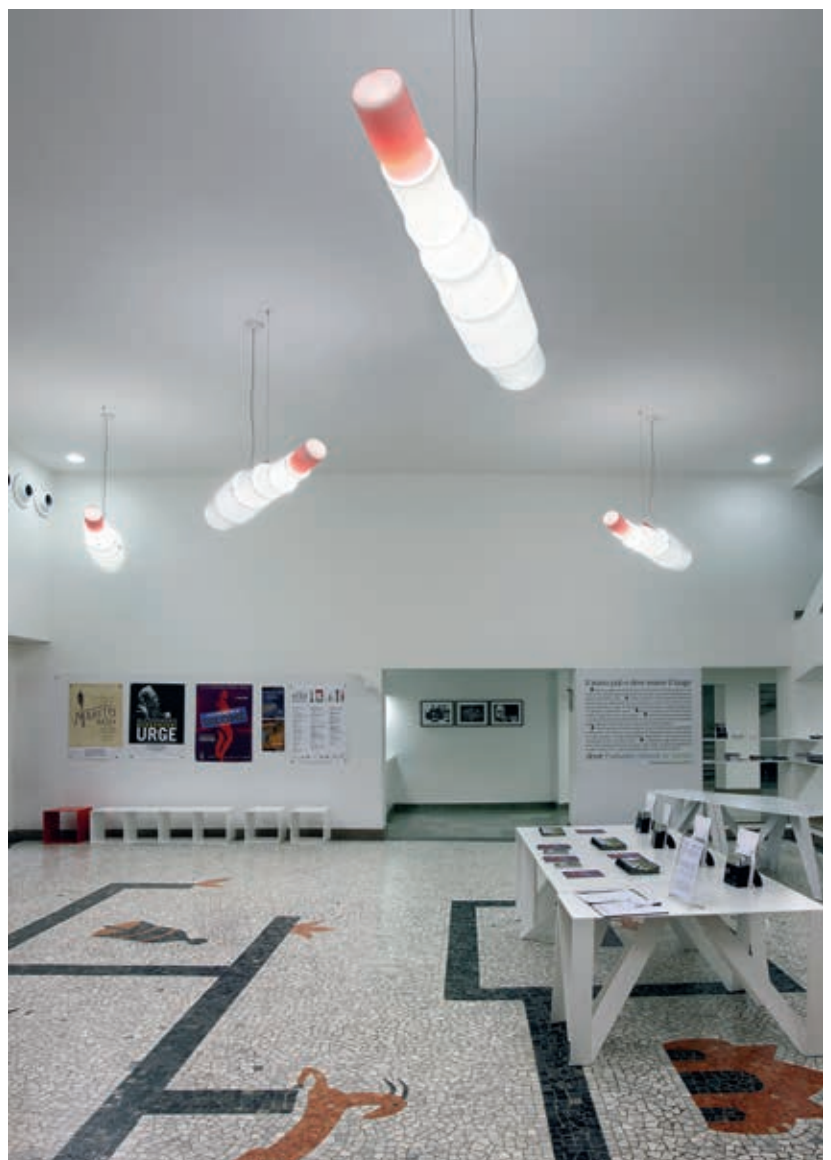

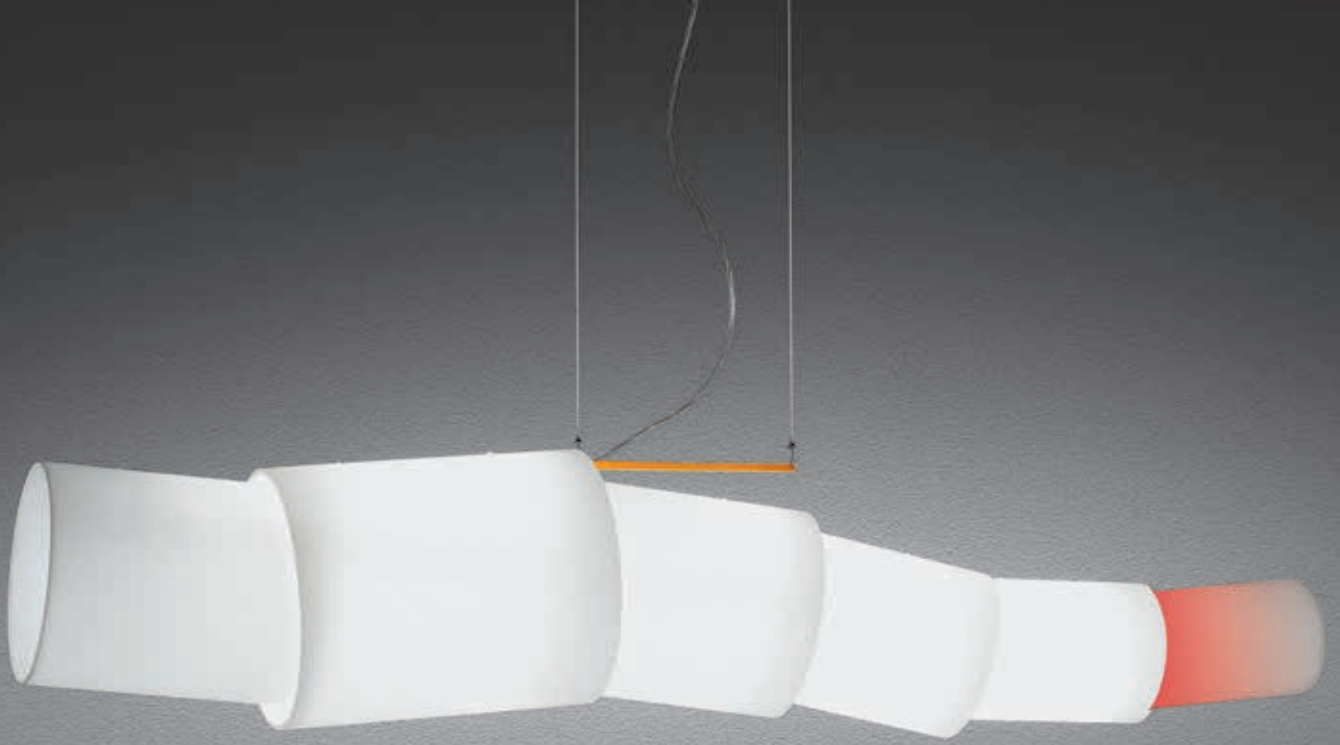

Artemide. Augmented reality

Questo è un catalogo interattivo.

Utilizza un tablet o uno smartphone per godere l'esperienza della Realtà Aumentata e scoprire tutti i contenuti interattivi del catalogo.

This is an interactive catalogue.
You can either use your tablet or smartphone to enjoy the Augmented reality experience and discover the interactive contents of the catalogue.

Ceci est un catalogue interactif.
Vous pouvez utiliser votre tablette ou votre smartphone pour profiter de l'expérience de la Réalité Augmentée et ainsi découvrir tous les contenus interactifs du catalogue.

Dies ist ein interaktiver Katalog.
Sie können sowohl Ihr Tablet als auch Ihr Smartphone nutzen, um den interaktiven Inhalt dieses Kataloges zu entdecken und die Augmented Reality zu erleben.

Este es un catálogo interactivo.
Usted puede utilizar su tableta o smartphone para disfrutar de la experiencia Augmented reality y descubrir todos los contenidos interactivos del catálogo.

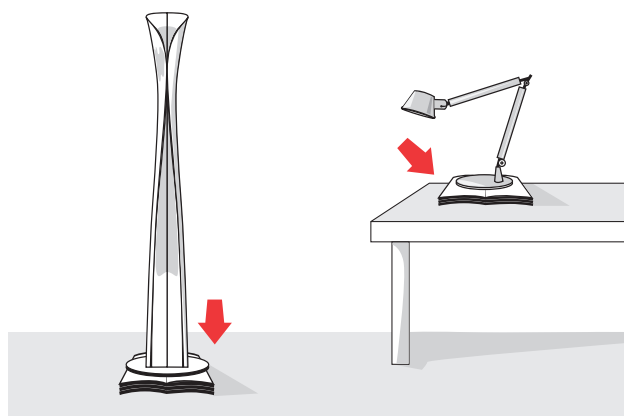

Posiziona il catalogo nella posizione in cui desideri vedere la lampada all'interno della tua casa o del tuo ufficio.

Place the catalogue in the required location to see the 3D model of the product in your house or office.

Placez le catalogue à l'endroit où vous souhaitez voir le produit dans votre maison ou votre bureau.

Platzieren Sie den Katalog an dem Ort, an dem Sie das ausgewählte Produkt zu Hause oder im Büro sehen möchten.

Coloque el catálogo en el lugar que se desea ver el producto alrededor de su casa u oficina.

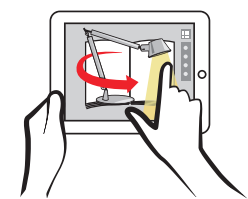

Sperimenta la 3D Augmented Reality. Accendi e spegni la lampada toccando il "logo lampadina".

Enjoy the 3D Augmented reality. Touch the "bulb logo" to turn the light ON and OFF.

Profitez de la réalité augmentée 3D et appuyez sur le « logo ampoule » pour allumer ou éteindre le luminaire.

Erleben Sie Augmented Reality. Schalten Sie mit dem Lichtschalter das Licht AN und AUS.

Disfrute de la Augmented reality en 3D. Toque el "logo bombilla" para encender o apagar la luz

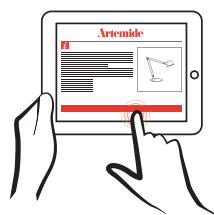

Sfoglia il menu per vedere tutti i colori, le caratteristiche tecniche e connettiti al sito web di Artemide per avere maggiori informazioni.

Browse the menu to see all the finishes, technical features and connect to Artemide website for more information.

Parcourez le menu pour voir tous les coloris, les caractéristiques techniques et également se connecter au site Artemide pour plus d'informations.

Im Menü finden Sie Farbvarianten, technische Informationen und die direkte Verlinkung zur Artemide Website für weitere Informationen.

Explorar el menú para ver todos los colores, características técnicas y conectarse a la página web Artemide para más información.

Launch Artemide app and scan the page to see the Augmented Reality of all the products in full size.

Download the Artemide app



Scan the page to see all the products in full size

Descrizione
 Description
 Description
 Beschreibung
 Descripción

Pagina prodotti coordinati
 Matching item pages
 Pages coordonnées
 Passende Seiten
 Páginas de productos relacionados



Led

Halo

design

Karim Rashid
 2011

Emissione luminosa
 Light emission
 Emission lumineuse
 Lichtverteilung
 Emisión de luz

Light emission  Colour  White

Colori
 Colours
 Couleurs
 Farbe
 Colores

Awards
 2012 - IF Product Design Award
 Hannover (Deutschland)

Premi / Musei
 Awards / Museums
 Prix / Musées
 Auszeichnungen / Museen
 Premios / Museos

Materiali: base e stelo in metallo verniciato; diffusore in gomma siliconica.
Specificità: l'impiego di uno snodo centrale permette di impugnare direttamente il diffusore e orientarlo sul piano verticale tra 0 e 90°. Il flusso dei Led è costante e uniforme lungo tutto l'anello luminoso.

Materials: Painted metal base and stem; silicone rubber diffuser.

Matériaux : Base et tige en métal verni ; diffuseur en silicone.

Materialien: Sockel und Stab aus lackiertem Metall; Schirm aus Silikon Gummi.

Materiales: de metal pintado y de goma siliconica.

Specification: Thanks to the central pivot you can handle the diffuser directly to lean it vertically from 0 to 90 degrees. The flux of the LED is constant and uniform along the whole lighting ring.

Spécificité : L'emploi d'une rotule centrale permet d'empoigner le diffuseur directement et l'orienter sur le plan vertical entre 0 et 90°. Le flux des Led est constant et uniforme dans tout l'anneau lumineux.

Spezifikation: Der zentrierte Stab ermöglicht die variable vertikale Positionierung des Leuchtenkopfs von 0° bis 90°. Der Lichtstrom der Led entlang des gesamten Rings ist konstant und gleichmäßig.

Especificación: de un nudo central permite manejar directamente el difusor y orientarlo verticalmente entre 0 y 90°. El flujo de los Led es constante y uniforme a lo largo de todo el anillo luminoso.

Dimensioni in mm
 Dimensions in mm
 Dimensions en mm
 Maße in mm
 Diseño acotado en mm

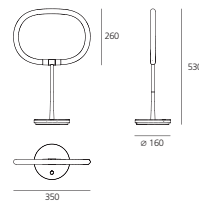

Sorgente luminosa
 Light source
 Source
 Leuchtmittel
 Lámpara

LED Total power 13,5W
 Warm white 4000K
 Lighting output 1140lm

LED:

Potenza totale apparecchio
 Connected load
 Puissance consommée
 Anschlussleistung
 Potencia total

Grado di protezione
 Protection degree
 Indice de protection
 Schutzart
 Grado de protección

Etichetta energetica
 Energy label
 Etiquette énergétique
 Energieeffizienzlabel
 Etiqueta energética

Classe
 Class
 Classe
 Klasse
 Clase

Temperatura colore
 Color temperature
 Température de couleur
 Farbtemperatur
 Temperatura de color

Flusso in uscita dall'apparecchio
 Total luminous flux of luminaire
 Flux de l'appareil
 Leuchten Lichtstrom
 Flujo luminoso total

Omologazioni
 Approvals
 Certifications
 Prüfzeichen
 Homologaciones

Dimmer posto sull'apparecchio
 Dimmer on the unit
 Variateur d'intensité lumineuse sur l'appareil
 Dimmer an der Leuchteneinheit
 Dimmer en lámpara

IP20     Dimmer

Energy Label n°1



LED

LED

Tutti gli apparecchi Artemide con sorgenti Led sono stati testati secondo la norma IEC 62471:2006 sicurezza fotobiologica delle lampade.

All Artemide fixtures mounting Led sources have been tested according to the standard IEC IEC 62471:2006 photobiological safety of lamps.

Tous les appareils Artemide utilisant des sources à Led ont été testés selon la norme IEC 62471:2006 sécurité photobiologique des lampes.

Alle mit LED bestückten Artemide Leuchten wurden gemäß des IEC 62471:2006 (Standard für photobiologische Sicherheit von Lampen) getestet.

Todos los aparatos Artemide con bombilla Led han sido testados según la norma IEC 62471:2006 seguridad fotobiológica de las lámparas.

Light emission



Diretta
Direct
Directe
Direkt
Directa



Indiretta
Indirect
Indirecte
Indirekt
Indirecta



Diretta e indiretta
Direct and indirect
Directe et indirecte
Direkt und indirekt
Directa e indirecta



Diffondente
Diffused
Diffuse
Gestreut
Difusa



Orientabile
Adjustable
Orientable
Verstellbar
Orientable



My White Light



Metamorfosi

Lamps typology



Lampade da tavolo
Table lamps
Lampes de table
Tischleuchten
Lámparas de sobremesa



Lampade da terra
Floor lamps
Lampadaires
Stehleuchten
Lámparas de pie



Lampade da parete
Wall lamps
Appliques
Wandleuchten
Apliques



Lampade da soffitto
Ceiling lamps
Plafonniers
Deckenleuchten
Plafones



Lampade a sospensione
Suspension lamps
Suspensions
Pendelleuchte
Lámparas de suspensión

Protection degree

IP...

Gli apparecchi elettrici sono predisposti per impedire l'intrusione e il contatto di corpi solidi e liquidi con le parti in tensione. La resistenza alla penetrazione di solidi o liquidi è espressa dalla sigla IP, seguita da due numeri che esprimono il grado di protezione: la prima cifra è riferita ai corpi solidi, la seconda ai liquidi.

Electric fittings are preset in order to prevent the intrusion and contact with solids and liquids with live parts. Resistance against the penetration of solids and liquids is expressed by the initials IP, followed by two digits that stand for the degree of protection: the first referring to solids, the second to liquids.

Les appareils électriques sont conçus afin d'éviter toute intrusion ou contact de corps solides et liquides avec les parties sous tension. La résistance à la pénétration de solides ou liquides est exprimée par le sigle IP, suivi de deux chiffres qui expriment le degré de protection: le premier chiffre concerne les corps solides, le second les liquides.

Die Leuchten sind ausgestattet, um das Eindringen und den Kontakt von Festkörpern und Flüssigkeiten zu verhindern. Hinter den Kennbuchstaben "IP" gibt die erste Kennziffer den Fremdkörperschutz an, die zweite Kennziffer den Schutz gegen Eindringen von Wasser.

Los aparatos eléctricos están preparados para impedir la entrada y el contacto de cuerpos sólidos y de líquidos con las partes eléctricas. La resistencia a la penetración de sólidos y líquidos se expresa mediante las siglas IP seguidas de un número de dos dígitos que expresa el grado de protección: el primer dígito se refiere a los objetos sólidos, y el segundo, a los líquidos.

Approvals



Certificazione di conformità europea

Certification of European conformity

Certificat de conformité à la norme Européenne

Zertifizierung nach der europäischen Norm

Certificado de conformidad europeo



EAC - Certificazione di conformità valida per l'unione doganale EurAsEC

EAC - Certification for Eurasian Customs Union

EAC - Certificat de conformité pour la Union douanière Eurasienne

EAC - Zertifizierung nach der europäischen Norm für die Eurasische Wirtschaftsgemeinschaft

EAC - Certificado de conformidad con validez para la Unión Euroasiática



CCC - China Compulsory Certification

CCC - China Compulsory Certification

CCC - Certificat de conformité pour la Chine

CCC - Zertifizierung nach der europäischen Norm für die China

CCC - Certificado de conformidad con validez para la China

Class



Classe I - Class I - Classe I - Klasse I - Clase I

Apparecchio nel quale la sicurezza elettrica è garantita da un conduttore supplementare di protezione (messa a terra) collegato alla struttura metallica della lampada.

A light fitting whose safety is guaranteed by an additional protective conductor (earth) connected with the metal frame of the lamp.

Appareil où la sécurité électrique est garantie par un conducteur supplémentaire de protection (mise à la terre) connecté à la structure métallique de la lampe.

Beim Betrieb und bei der Wartung müssen alle berührbaren Metallteile der Leuchte, die im Fehlerfall Spannung annehmen können, leitend mit dem Schutzleiteranschluß verbunden sein.

La seguridad eléctrica está garantizada por un cable protector adicional (toma de tierra) conectado a la estructura metálica del aparato.



Classe II - Class II - Classe II - Klasse II - Clase II

Apparecchio nel quale la protezione contro la scossa elettrica non si basa unicamente sull'isolamento fondamentale, ma anche sulle misure supplementari di sicurezza costituite dal doppio isolamento o dall'isolamento rinforzato. Queste misure non comportano dispositivi per la messa a terra e non dipendono dalle condizioni di installazione.

Light fittings whose safety is guaranteed by the double reinforced insulation of conductive parts, with no earth.

Appareil où la sécurité électrique est garantie par un double niveau d'isolation sans dispositif de mise à la terre.

Bei Leuchten der Klasse II ist der Berührungsschutz durch eine Schutzisolierung gegeben. Alle spannungsführenden Teile haben außer der Betriebsisolation noch eine zusätzliche Isolation.

Aparatos con protección contra descargas eléctricas basada no sólo en el aislamiento fundamental sino también en medidas adicionales de seguridad constituidas por un doble aislamiento o un aislamiento reforzado. Estas medidas no incluyen dispositivo de toma de tierra y no dependen de las condiciones de la instalación.



Classe III - Class III - Classe III - Klasse III - Clase III

Apparecchio in cui la protezione contro la scossa elettrica si basa sull'alimentazione a bassissima tensione di sicurezza e in cui non si producono tensioni superiori alla stessa. Nota: un apparecchio in classe III non deve essere provvisto di messa a terra di protezione.

This light fixture is fitted with a protection device against electric shock that features a very low voltage power supply and prevents it from generating higher voltages. Note: a class III fixture does not have to be equipped with a protection grounding.

Appareil dans lequel la protection contre les chocs électriques se base sur l'alimentation à très basse tension de sécurité et dans lequel ne se produisent pas de tensions supérieures à 50V. Note: un appareil classe III ne nécessite pas de mise à la terre.

Diese Leuchte ist mit einer Schutzvorrichtung versehen, die einen Betrieb mit einer Schutzkleinspannung vorsieht und keine höheren Spannungen zuläßt. Bemerkung: eine Leuchte der Klasse III wird mit keiner Schutzerdung ausgestattet.

Aparatos en los que la protección contra descargas eléctricas se basa en un sistema de alimentación de bajo voltaje que impide que se generen voltajes superiores. Nota: un aparato de clase III no debe equiparse con toma de tierra.

Sorgenti luminose
Light sources
Sources lumineuses
Leuchtmittel
Lámparas

La Direttiva 2005/32/CE Eup impone che non siano più immesse sul mercato le sorgenti che non rispondono ai requisiti di efficienza atti a garantire un consumo eco-sostenibile e alogene con bulbo opalino (per approfondimenti vedi www.artemide.com).

Per chi ha acquistato prodotti Artemide prima della pubblicazione della normativa, può utilizzare in alternativa le sorgenti indicate in questo catalogo, ammesse dalla Direttiva e che, a parità di flusso luminoso, consumano meno.

Artemide raccomanda di non montare lampadine diverse da quelle suggerite su questo catalogo, per evitare di compromettere le funzioni dell'apparecchio (per esempio la possibilità di dimmerarne il flusso).

EEC Directive 2005/32/CE provides that light sources not complying to environmental energy efficiency requirements, in particular incandescent and halogen opal bulbs, will no longer be available on the market. For further information regarding this, please go to www.artemide.com

Customers who purchased Artemide products before the Directive took effect can use light sources listed in this catalogue; these light sources, allowed by the Directive, provide the same amount of light and are more energy efficient.

Artemide recommends not to install different bulbs than the ones suggested in this catalogue, in order not to damage the capabilities of the fitting (eg dimming).

La directive 2005/32/CE indique que les sources lumineuses ne se conforment pas aux exigences environnementales d'efficacité énergétique, en particulier les ampoules incandescentes et halogènes opales, ne seront plus disponibles sur le marché. Pour plus de renseignements à ce sujet, veuillez consulter le site www.artemide.com

Les clients, ayant acheté des produits Artemide avant que la directive ne prenne effet, peuvent utiliser les sources lumineuses indiquées dans le catalogue ; ces sources lumineuses, acceptées par la directive, fournissent la même intensité de lumière et ont un rendement plus efficace.

Artemide recommande de ne pas installer d'autres ampoules que celles mentionnées dans le catalogue, ceci dans le but de ne pas endommager le fonctionnement des appareils (par exemple la variation de lumière).

Die EEC Direktive 2005/32/CE besagt, dass Leuchtmittel, die nicht den Anforderungen an Energieeffizienz entsprechen, insbesondere Glühlampen und Halogenlampen, nicht mehr vertrieben werden dürfen. Weitere Informationen zu diesem Thema finden Sie auf unserer Internetseite www.artemide.com.

Kunden, die vor Inkrafttreten dieser Direktive Artemide Produkte erworben haben empfehlen wir, auf die in diesem Katalog aufgeführten Leuchtmittel, die den Richtlinien entsprechen, auszuweichen. Diese haben die selbe Lichtausbeute bei geringerem Energieverbrauch.

Wir empfehlen ausdrücklich nur die in diesem Katalog aufgeführten Leuchtmittel einzusetzen, um eine Beschädigung der Leuchte (insbesondere bei Produkten mit Dimmfunktion) zu vermeiden.

La Directiva 2005/32/CE Eup impone que no se comercialicen en el mercado las fuentes luminosas que no respondan a los requisitos de eficiencia aptos para garantizar un consumo eco-sostenible de energía, en particular las fuentes luminosas incandescentes y halógenas con bombilla opal (para más información visitar www.artemide.com).

Para aquellos que hayan adquirido productos Artemide anteriormente a la publicación de la normativa, pueden utilizar como alternativa las fuentes indicadas en este catálogo, admitidas en las Directiva y que, a igualdad de flujo luminoso, tienen un consumo menor.

Artemide recomienda no instalar bombillas diferentes a las sugeridas en este catálogo, para evitar comprometer las funciones del aparato (por ejemplo la posibilidad de dimerizar el flujo).





See data in the product pages









Halogen



	28W	230V	E27	HALO	warm white	2800K	345lm
	40W	230V	E27	HALO	warm white	2800K	490lm
	46W	230V	E27	HALO	warm white	2800K	630lm
	52W	230V	E27	HALO	warm white	2800K	820lm
	60W	230V	E27	HALO	warm white	2700K	710lm
	77W	230V	E27	HALO	warm white	2900K	1180lm
	100W	230V	E27	HALO	warm white	2900K	1800lm
	150W	230V	E27	HALO	warm white	2900K	2870lm
	150W	230V	E27	PAR38	warm white	2900K	2870lm
	18W	230V	E14	HALO	warm white	2800K	170lm
	28W	230V	E14	HALO	warm white	2800K	345lm
	42W	230V	E14	HALO	warm white	2800K	630lm
	46W	230V	E14	HALO	warm white	2800K	630lm
	60W	230V	E14	HALO	warm white	2800K	820lm
	80W	230V	R7s	HALO	warm white	2900K	1450lm
	120W	230V	R7s	HALO	warm white	2950K	2300lm
	160W	230V	R7s	HALO	warm white	2950K	3300lm
	230W	230V	R7s	HALO	warm white	2950K	5000lm
	330W	230V	R7s	HALO	warm white	2950K	5000lm
	400W	230V	R7s	HALO	warm white	2950K	9000lm
	20W	12VG4	QT9		warm white	3000K	320lm
	48W	230V	G9	HALO	warm white	2800K	740lm
	60W	230V	G9	HALO	warm white	2900K	790lm
	100W	230V	G53	QR111	warm white	3000K	1013lm
	35W	12VGY6,35	QT12		warm white	2900K	860lm
	50W	12VGY6,35	QT12		warm white	3000K	1180lm
	35W	12VGU4	QRCBC35		warm white	3000K	547lm
	50W	12VGU5,3	QRCBC51		warm white	3000K	862lm
	70W	230V	B15d	HALO	warm white	2900K	1180lm
	100W	230V	B15d	HALO	warm white	2900K	1800lm
	150W	230V	B15d	HALO	warm white	2900K	2870lm
	205W	230V	B15d	HALO	warm white	2900K	4200lm

Incandescent









	60W	E27	R63	warm white	2700K	960cd
	80W	E27	R80	warm white	2700K	345cd

Fluorescent

	18W	230V	GX24q-2	TC-TEL	warm white	3000K	1200lm
	26W	230V	GX24q-3	TC-TEL	warm white	3000K	1800lm
	32W	230V	GX24q-3	TC-TEL	warm white	3000K	2400lm
	42W	230V	GX24q-4	TC-TEL	warm white	3000K	3200lm
	57W	230V	GX24q-5	TC-TEL	warm white	3000K	4300lm
	70W	230V	GX24q-6	TC-TEL	neutral white	4000K	5200lm
	18W	230V	2G10	TC-F	warm white	3000K	1100lm
	24W	230V	2G10	TC-F	warm white	3000K	1700lm
	36W	230V	2G10	TC-F	warm white	3000K	2800lm
	36W	230V	2G11	TC-LEL	warm white	3000K	2900lm
	55W	230V	2G11	TC-LEL	warm white	3000K	4800lm
	80W	230V	2G11	TC-LEL	warm white	3000K	6500lm
	9W	230V	G23	TC-S	warm white	3000K	600lm
	11W	230V	G23	TC-S	warm white	3000K	900lm
	10W	230V	G24d-1	TC-D	warm white	3000K	600lm
	18W	230V	G24d-2	TC-D	warm white	3000K	1200lm
	26W	230V	G24d-3	TC-D	warm white	3000K	2600lm
	13W	230V	G24q-1	TC-DEL	warm white	3000K	900lm
	18W	230V	G24q-2	TC-DEL	warm white	3000K	1200lm
	15W	230V	E27	TC-TSE	warm white	2700K	800lm
	20W	230V	E27	TC-TSE	warm white	2700K	1230lm
	23W	230V	E27	TC-TSE	warm white	2700K	1500lm
	20W	230V	E27	globe	warm white	2700K	1200lm
	23W	230V	E27	globe	cold white	6500K	1380lm
	28W	230V	E27	TC-SER	warm white	2700K	1700lm
	11W	230V	W4,3x8,5d	T7	warm white	3000K	750lm
	13W	230V	W4,3x8,5d	T7	warm white	3000K	930lm

	24W	230V	G5	T16	warm white	3000K	1750lm
	28W	230V	G5	T16	warm white	2700K	2600lm
	35W	230V	G5	T16	warm white	3000K	3300lm
	39W	230V	G5	T16	warm white	3000K	3500lm
	39W	230V	G5	T16	cold white	6500K	3325lm
	54W	230V	G5	T16	warm white	3000K	5000lm
	80W	230V	G5	T16	warm white	3000K	7000lm
		55W	230V	2GX13	T16-R	warm white	3000K
	18W	230V	G13	T26	warm white	3000K	1350lm
	36W	230V	G13	T26	warm white	3000K	3300lm
	58W	230V	G13	T26	warm white	3000K	5200lm

Metal Halide

	35W	230V	E27	HIE-CE	warm white	3000K	3200lm
	70W	230V	E27	HIE-CE	warm white	3000K	5200lm
	100W	230V	E27	HIE-CE	warm white	3000K	8500lm
	150W	230V	E27	HIE-CE	warm white	3000K	12900lm
	250W	230V	E40	HIE-CE	warm white	3000K	24500lm
	400W	230V	E40	HIE-CE	warm white	3000K	42000lm
	35W	230V	G8,5	HIT-TC-CE	warm white	3000K	3500lm
	70W	230V	G8,5	HIT-TC-CE	warm white	3000K	6900lm
	250W	230V	Fc2	HIT-DE-CE-h45	warm white	3000K	25000lm
	70W	230V	GX8,5	HIR111-CE-P	warm white	3000K	5500cd
LED							
	4,5W	230V	E14	LED	warm white	2700K	250lm
	6W	230V	E14	LED	warm white	2700K	470lm
	12W	230V	E27	LED	warm white	2700K	650lm
	14,5W	230V	E27	LED	warm white	2700K	806lm
	17W	230V	E27	LED	warm white	2700K	1055lm
	20W	230V	E27	LED	warm white	2700K	1521lm
	8W	230V	GU10	LED	warm white	2700K	460lm
	10W	230V	GU10	LED	warm white	3000K	435lm

Etichetta energetica
Energy label
Etiquette énergétique
Energieeffizienzlabel
Etiqueta energética

Sul presente catalogo è riportato per ogni prodotto il riferimento alla corrispondente Energy Label (aggiornate al 1 marzo 2015).

Artemide monitora costantemente il parco sorgenti di proprio utilizzo, e sul sito ufficiale [artemide.com](http://artemide.com/download/energy-labels.action) (link diretto artemide.com/download/energy-labels.action) è disponibile l'etichetta aggiornata del Regolamento Delegato (UE) n.874/2012 della Commissione del 12 luglio 2012.

This catalogue lists for each product the reference number of the relevant Energy Label (updated to 1st march 2015).

Artemide always keeps its products updated based on the availability of light sources and/or their energy classification and on the official website www.artemide.com (direct link www.artemide.com/download/energy-labels.action), updated ENERGY LABEL of each product in compliance with the Commission Delegated Regulation (EU) No 874/2012 of July 2012 are present and constantly updated.

Ce catalogue liste pour chaque produit, le numéro de référence du label énergétique concerné (mise à jour effectuée le 1er mars 2015).

Artemide met ses produits continuellement à jour en fonction de la disponibilité des sources lumineuses et/ou leur classification énergétique. Les étiquettes en conformité avec la réglementation européenne (UE) N° 874/2012 de Juillet 2012 sont également mises à jour en continu et ce pour chaque produit. L'ensemble des étiquettes énergétiques Artemide est consultable en libre accès sur le site officiel artemide.com (lien direct artemide.com/download/energy-labels.action).

Im vorliegenden Katalog wird für jedes Produkt die Nummer des entsprechenden Energieeffizienzlabels angegeben (aktualisiert am 1. März 2015).

Artemide überwacht die verwendeten und empfohlenen Leuchtmittel kontinuierlich und veröffentlicht die ständig auf aktuellem Stand gehaltenen Energieeffizienzlabel auf der offiziellen Artemide-Webseite [artemide.com](http://artemide.com/download/energy-labels.action), (direkter Link: artemide.com/download/energy-labels.action). Die Energieeffizienzlabel entsprechen der "Delegierten Verordnung (EU) Nr. 874/2012 der Kommission vom 12. Juli 2012 zur Ergänzung der Richtlinie 2010/30/EU des Europäischen Parlaments und des Rates im Hinblick auf die Energieverbrauchskennzeichnung von elektrischen Lampen und Leuchten".

En el presente catálogo hay un listado para cada producto, del número de referencia de la correspondiente Etiqueta energética (actualizado hasta el 1 de marzo 2015).

Artemide siempre mantiene sus productos actualizados en base a la disponibilidad de fuentes de luz, y en la página web oficial artemide.com – sección "zona de descarga – etiqueta energética" (link directo artemide.com/download/energy-labels.action), se presentan y actualizan constantemente las Etiquetas energéticas de cada producto, conforme del Reglamento Delegado (UE) n° 874/2012 de la Comisión del 12 de Julio de 2012.

Energy label 1

This luminaire contains built-in LED lamps:

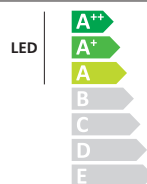

The lamps cannot be changed in the luminaire

Energy label 9

This luminaire is compatible with bulbs of the energy classes:

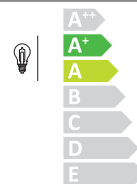

Energy label 4

This luminaire is compatible with bulbs of the energy classes:

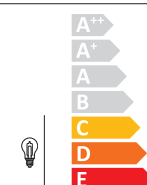

Energy label 12

This luminaire is compatible with bulbs of the energy classes:



The luminaire is sold with a bulb of the energy class:

Energy label 5

This luminaire is compatible with bulbs of the energy classes:



The luminaire is sold with a bulb of the energy class:

Energy label 13

This luminaire is compatible with bulbs of the energy classes:

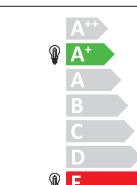

The luminaire is sold with a bulb of the energy class:

Energy label 6

This luminaire is compatible with bulbs of the energy classes:

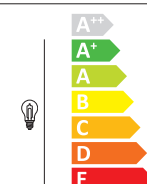

Energy label 14

This luminaire is compatible with bulbs of the energy classes:



Energy label 7

This luminaire is compatible with bulbs of the energy classes:



Energy label 15

This luminaire is compatible with bulbs of the energy classes:



The luminaire is sold with a bulb of the energy class:

Energy label 8

This luminaire contains built-in LED lamps:

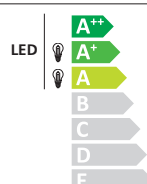

The luminaire is sold with a bulb of the energy class:

Energy label 16

This luminaire contains built-in LED lamps:

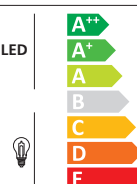

The luminaire is sold with a bulb of the energy class:

Energy label 17

This luminaire contains built-in LED lamps:

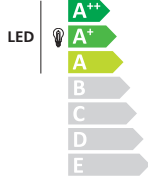

The luminaire is sold with a bulb of the energy class:



Energy label 23

This luminaire contains built-in LED lamps:



The luminaire is sold with a bulb of the energy class:



Energy label 30

This luminaire contains built-in LED lamps:

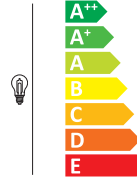

Energy label 36

This luminaire contains built-in LED lamps:



The luminaire is sold with a bulb of the energy class:



Energy label 18

This luminaire is compatible with bulbs of the energy classes:



The luminaire is sold with a bulb of the energy class:



Energy label 24

This luminaire is compatible with bulbs of the energy classes:

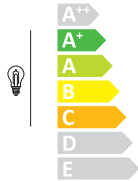

The luminaire is sold with a bulb of the energy class:



Energy label 31

This luminaire is compatible with bulbs of the energy classes:



The luminaire is sold with a bulb of the energy class:



Energy label 37

This luminaire is compatible with bulbs of the energy classes:

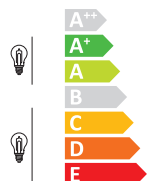

The luminaire is sold with a bulb of the energy class:



Energy label 19

This luminaire is compatible with bulbs of the energy classes:



Energy label 26

This luminaire is compatible with bulbs of the energy classes:

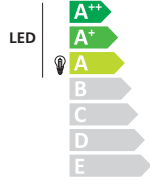

The luminaire is sold with a bulb of the energy class:



Energy label 32

This luminaire is compatible with bulbs of the energy classes:



The luminaire is sold with a bulb of the energy class:



Energy label 38

This luminaire is compatible with bulbs of the energy classes:



The luminaire is sold with a bulb of the energy class:



Energy label 20

This luminaire is compatible with bulbs of the energy classes:

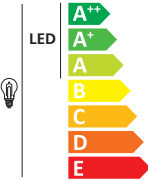

The lamps cannot be changed in the luminaire

Energy label 27

This luminaire is compatible with bulbs of the energy classes:



The luminaire is sold with a bulb of the energy class:



Energy label 33

This luminaire is compatible with bulbs of the energy classes:



The luminaire is sold with a bulb of the energy class:



Energy label 40

This luminaire is compatible with bulbs of the energy classes:

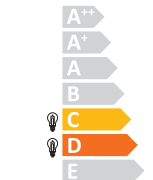

The luminaire is sold with a bulb of the energy class:



Energy label 21

This luminaire is compatible with bulbs of the energy classes:



The luminaire is sold with a bulb of the energy class:



Energy label 28

This luminaire is compatible with bulbs of the energy classes:



The luminaire is sold with a bulb of the energy class:



Energy label 34

This luminaire is compatible with bulbs of the energy classes:

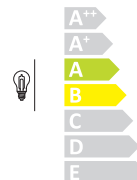

Energy label 41

This luminaire is compatible with bulbs of the energy classes:



The luminaire is sold with a bulb of the energy class:



Energy label 22

This luminaire contains built-in LED lamps:



The luminaire is sold with a bulb of the energy class:



Energy label 29

This luminaire contains built-in LED lamps:

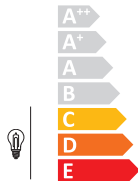

The luminaire is sold with a bulb of the energy class:



Energy label 35

This luminaire contains built-in LED lamps:

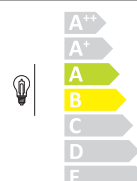

The luminaire is sold with a bulb of the energy class:



Energy label 54

This luminaire contains built-in LED lamps:

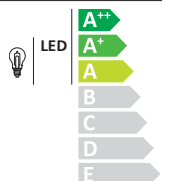

The luminaire is sold with a bulb of the energy class:



Headquarters

Artemide S.p.A.
Via Bergamo, 18
20010 Pregnana Milanese (MI), Italy
Tel. (+39) 02 93518.1 - 93526.1
Numero verde 800 834 093
(from Italy only)
info@artemide.com
www.artemide.com

Architectural division

Artemide Architectural S.A.S.
Z.I. du Breuil
18400 Saint Florent sur Cher, France
Tel. (+33) 02 48 23 99 00

Argentina

Head office and Showroom:
Edimetra S.A.
Paraguay 792, 3rd floor
1057 Buenos Aires
Tel. (+54) 4312 4871
info@artemide.com.ar

Austria

Head office and Showroom:
Artemide Handelsgesellschaft mbH
Gonzagagasse 1 / Morzinplatz
1010 Wien
Tel. (+43) 01 803 21 82
info@artemide.at

Australia

Australian Head office
and Adelaide Showroom:
Ornare Imports Pty. Ltd.
28 Fullarton Rd, Norwood SA 5067
Tel. (+61) 08 8362 3029
info@artemide.com.au
www.artemide.com.au

Office and Showrooms:

Sydney
504-508 Cleveland St
Surry Hills NSW 2010
Tel. (+61) 02 9699 8472
sydney@artemide.com.au

Melbourne

46-48 Raydowne St
Carlton VIC 3053
Tel. (+61) 03 9349 3310
melbourne@artemide.com.au

Benelux (Belgium/Holland/Luxemburg)

Head office: Horas S.A.
Beemdstraat 25
1601 Ruisbroek, Belgium
Tel. (+32) 02 334 84 50
artemide_benelux@artemide.com

Showroom and Lighting Consultancy Centers: Brussels

Chaussée de Waterloo 410
1050 Brussels - Belgium
Tel. (+32) 02 534 03 67
artemide.brussels@skynet.be

Amsterdam

Hobbemakade 89, 1071 XR
Amsterdam - Holland
Tel. (+31) 020 4702668
artemide.amsterdam@artemide.nl

Canada

Head office: Artemide Ltée/Ltd.
11105 rue Renaude Lapointe,
Montréal, Québec H1J 2T4
Tel. (+1) 514 323 6537
Toll free (+1) 888 777 2783
infocanada@artemide.net
www.artemide.net

Showrooms:

Toronto
5 Mill Street,
Toronto, Ontario M5A 3R6
Tel. (+1) 416 628 6718
toronto@artemide.net

Sales office:

Montréal
Tel. (+1) 514 788 3788
montreal@artemide.net

China

Head office and Showroom:
Artemide Trading
(Shanghai) Co., Ltd.
Room 1907, 19/F, New Hualian
Mansion, East Wing, 755 Middle Huai
Hai Road, Huang Pu District, Shanghai
Tel. (+86) 21 6448 3650
info@artemide.cn

Affiliated Showrooms: Beijing

Unit B245, Cofco Plaza,
No. 8 Jianguomennei Street,
Dongcheng District, Beijing
Tel. (+86) 10 8511 8718

Unit 1-B-20, International Furniture
Hall, Easy Home, No. 65 North 4th
Ring Road, Chaoyang District, Beijing
Tel. (+86) 10 8463 6098

France

Head Office and Showroom:
Artemide France S.A.S.
52, avenue Daumesnil, 75012 Paris
Tél. (+33) 01 43 44 44 44
artemide@artemide.fr

Germany

Head office and Showroom:
Artemide GmbH
Hans-Böckler-Straße 2
58730 Fröndenberg
Tel. (+49) 02373 975.0
info@artemide.de

Office:
München
Luise-Ullrich-Straße 20
80636 München
Tel. (+49) 089/70065198
muenchen@artemide.de

Showroom:
Frankfurt
Baseler Straße 10, 60329 Frankfurt
Tel. (+49) 069 3399 5690

Great Britain

Head office, Showroom and Lighting Consultancy Center:
Artemide GB Ltd.
106 Great Russell Street,
London WC1B 3NB
Tel. (+44) 020/7631 5200
info@artemide.co.uk

Greece

Head office and Showroom:
Artemide Hellas S.A.
34, Solonos Str., 10 673 Athens
Tel. (+30) 0210 364 6770.4.5
info@artemide.gr

Showroom:
Thessaloniki
92, G. Papandreou Str.
54 665 Thessaloniki
Tel. (+30) 02310 403 934.5

Hong Kong

Head office and Showroom:
Artemide Ltd.
Unit 1303, 13/F, Ruttonjee House
Ruttonjee Centre, 11 Duddell
Street Central, Hong Kong
Tel. (+852) 2523 0050
info@artemide.com.hk

Showroom:
Shop 102-103,
Ruttonjee Centre,
11 Duddell Street Central, Hong Kong
Tel. (+852) 2523 0333

India

Head office:
Artemide Lighting India Pvt. Ltd.
Unit no 5, 2nd floor
Raghuvanshi Mansion
Raghuvanshi Mills Compound
Senapati Bapat Marg, lower parel
Maharashtra, Mumbai 400013
Tel. (+91) 22 61774800
info@artemide.in

Italy

Head office:
Artemide Italia s.r.l.
Via Bergamo 18
20010 Pregnana Milanese (MI)
Tel. (+39) 02 93518.1 - 93526.1
Numero Verde 800 834 093
info@artemide.com

Showrooms:
Milano
Corso Monforte 19, 20122 Milano
Tel. (+39) 02 76006930 - 794039
monforte@artemide.com

Via Manzoni 12, 20121 Milano
Tel. (+39) 02 778712201 - 78712202
manzoni@artemide.com

Roma
Via Margutta 107, 00187 Roma
Tel. (+39) 06 36001802 - 36001808
margutta@artemide.com

Lighting Consultancy Centers:
Milano
Via Manzoni 12, 20121 Milano
Tel. (+39) 02 778712201 - 78712202
manzoni@artemide.com

Roma
Via Pisanelli 1, 00196 Roma
Tel. (+39) 06 94537550
pisanelli@artemide.com

Japan

Head office:
Artemide Japan K.K.
#2013 1-41-7 Tomigaya Shibuya-ku,
151-0063 Tokyo Japan
Tel. (+81) 3 5738 7410
info@artemide.co.jp

Malaysia

Distributor:
Lightcraft (KL) Sdn Bhd
145-5&6, Jalan Sungai Besi, 57100
Kuala Lumpur, Malaysia
Tel: (+603) 9222 4219
info@lightcraft.com.my

Mexico

Head Office
Showroom & Customer Service:
Scultura Luminosa
Suderman # 246
Col Chapultepec Morales
Mexico D.F., 11570
Tel (+55) 5250 2661
info@artemide.mx

Portugal

Head office and Showroom:
Foton Iluminação Ltda
Rua da Garagem 3
2795-510 Carnaxide
Tel. (+351) 21 416-90-70; 71; 72
geral@foton.pt

Russia

Head office:
Artemide Agency OOO
Bolshoj Zlatoustinskij Pereulok, Bldg
1, office 100, 101000 Moscow
Tel. (+7) 495 984 2238
info@artemide-agency.ru

Scandinavia

Head office & Showroom:
Artemide Scandinavia A/S
Skudehavnsvej 5 D-2100
Copenhagen, Denmark
Tel. (+45) 7020 1700
info@artemide.dk

Singapore

Distributor:
Million Lighting Co Pte Ltd
203 Kallang Bahru
Singapore 339340
Tel. (+65) 6743 2033
enquiry@millionlighting.com

South Korea

Distributor:
Duomo & Co., Ltd.
Taeyang B/D 33-17 Nonhyun-dong
Gangnam-gu, Seoul
Tel. (+82) 02 512 5829
info@duomokorea.com
www.duomokorea.com

Spain

Head office: Artemide S.A.
C/Vico, 12-18, 08021 Barcelona
Tel. (+34) 093 478 3911
artemide@artemide.es

Switzerland

Head office and Showroom:
Artemide Illuminazione S.A.
Bären-Gasse 16, 8001 Zürich
Tel. (+41) 043 268 2727
info@artemide.ch

Taiwan

Distributor:
Bravocasa Co., Ltd.
No. 121, Sec. 4, Ren'ai Rd., Da'an
Dist., Taipei City 106,
Taiwan (R.O.C.)
Tel: +886 2 27755197
sonya@bravocasa.com.tw

United Arab Emirates

Representative Office:
Artemide Middle East Dubai
P.O. Box 18526 Dubai, LOB 16-204
Jebel Ali Free Zone
Tel. (+971) 4 887 2022
info@artemide.ae

U.S.A.

Headquarters
Artemide, Inc.
250 Karin Lane
Hicksville, NY 11801
Tel. (+1) 631 694 9292
Toll free (+1) 877 Art 9111
infousa@artemide.net
www.artemide.net

Showrooms:
Chicago, IL
351 W Hubbard street, #100
Chicago, IL 60654
Tel. (+1) 312 475 0100
chicago@artemide.net

Los Angeles, CA
9006 Beverly Blvd.
West Hollywood, CA 90048
Tel. (+1) 310 888 4099
losangeles@artemide.net

Miami, FL
2222 Ponce de Leon Boulevard
Coral Gables, FL 33134
Tel. (+1) 305 444 5800
miami@artemide.net

New York, NY
46 Greene Street
New York, NY 10013
Tel. (+1) 212 925 1588
newyork@artemide.net

Sales office:
Dallas, TX
Tel. (+1) 214 747 8344
dallas@artemide.net

Philadelphia, PA
Tel. (+1) 215 733 9877
philadelphia@artemide.net

San Francisco, CA
Tel. (+1) 415 393 9955
sanfrancisco@artemide.net

© Artemide S.p.A.

Contents and editing
Carlotta de Bevilacqua
with
Ippolita Ciampini
Diego Martinelli

Artemide Research & Innovation
Fabio Zanola

Graphic design
Studio Cerri & Associati
Pierluigi Cerri
Alessandro Colombo
with
Roberto Libanori

Cover
Elliott Erwitt

IN-EI Issey Miyake photos
Hiroshi Iwasaki

Still lifes
Ballo & Ballo
Jean Pierre Maurer
Manuel Maurer
Gio Pini
Federico Villa
Miro Zagnoli

Image editing
and 3D visualization
Paola Monaco di Arianello
Simone Fantoni

Prepress
Actualtype s.r.l.

Press
Faenza Group
March 2015



Compasso D'oro
1967-1989-1994-2004



Winner European
Design Prize '97



ISO 9001:2008



ISO 14001:2004



BILAN CARBONE®



CTF STAGE2
ISO 17025

Artemide S.p.A.
si riserva la facoltà di modificare, in qualunque
momento e senza preavviso, le caratteristiche
tecniche degli elementi illustrati nel presente
catalogo.

Artemide S.p.A.
reserves the right to change, at any time and
without prior warning, the technical specifications
of any product illustrated in this catalogue.

Artemide S.p.A.
se réserve le droit de modifier, à n'importe
quel moment et sans préavis, les caractéristiques
techniques des éléments illustrés dans ce
catalogue.

Artemide S.p.A.
behält sich das Recht vor jederzeit und ohne
Ankündigung die technischen Daten der im
Katalog abgebildeten Produkte zu ändern.

Artemide S.p.A.
se reserva la facultad de modificar, en cualquier
y sin aviso previo, las características técnicas
de los elementos ilustrados en el presente
catálogo.